CANopen Slave Device

CAN-2057C

Application User's Manual

Warranty

Without contrived damage, all products manufactured by ICP DAS are warranted in one year from the date of delivery to customers.

Warning

ICP DAS revises the manual at any time without notice. However, no responsibility is taken by ICP DAS unless infringement act imperils to patents of the third parties.

Copyright

Copyright © 2010 is reserved by ICP DAS.

Trademark

The brand name ICP DAS as a trademark is registered, and can be used by other authorized companies.

Contents

1	Introduction.....	3
1.1	Overview.....	3
1.2	Hardware Specifications	4
1.3	Features.....	5
1.4	Application	6
2	Hardware	7
2.1	Structure.....	7
2.2	Node ID & Baud Rate Rotary Switch	8
2.3	I/O Pair-connection Mode.....	9
2.4	LED Description.....	11
2.5	PIN Assignment	12
2.6	Wire Connection	13
3	Object Dictionary.....	14
3.1	Object List.....	14
3.2	Store and Restore Object.....	19
3.3	Application Object.....	20
3.4	Default PDO Mapping.....	23

1 Introduction

1.1 Overview

CAN-2057C is a CANopen slave module and it has 16 Digital output channels with open-collector output type. It can be used to develop powerful and cost effective digital control system.



Figure 1-1 CAN-2057C

1.2 Hardware Specifications

Digital Output:

- Output Channels: 16 (Sink)
- Output Type: Open-collector.
- Max Load Current: 600 mA per channel.
- Load Voltage: +5 V_{DC} ~ +30 V_{DC}.
- Intra-module Isolation, Field to Logic: 3750 Vrms.
- Reaction Time: 120 us.
- ESD Protection: 4 kV Contact for each channel.

Others:

- CANopen Status: 3 LEDs for PWR / RUN / ERR.
- Terminal Resister: 1 LED as terminator resister indicators
- DO LED: 16 LEDs as digital output indicators.
- Power Requirement: +10 ~ +30 V_{DC}, 1.0 W.
- Operating Temperature: -25 ~ +75 °C.
- Storage Temperature: -30 ~ +80 °C.
- Humidity: 10 to 90% RH, Non-condensing.
- Dimensions: 32.3 mm x 99 mm x 77.5 mm (W x L x H) Detail.

1.3 Features

- Standard CANopen general I/O slave devices.
- CANopen Version: DS-301, v4.02.
- Device Profile: DSP-401, v2.1
- Support I/O pair-connection mechanism.
- Provide normal/polarity 16 DO channels
- CANopen transfer rate: 10 kbps, 20 kbps, 50 kbps, 125 kbps, 250 kbps, 500 kbps, 800 kbps, 1000 kbps.
- Support maximum CANopen slave devices Node-ID up to 99.
- Support NMT, PDO, SDO, EMCY, SYNC, Guarding, and Heartbeat protocol.
- Pass the validation of CANopen conformance test
- Provide EDS file for CANopen master interface

1.4 Application

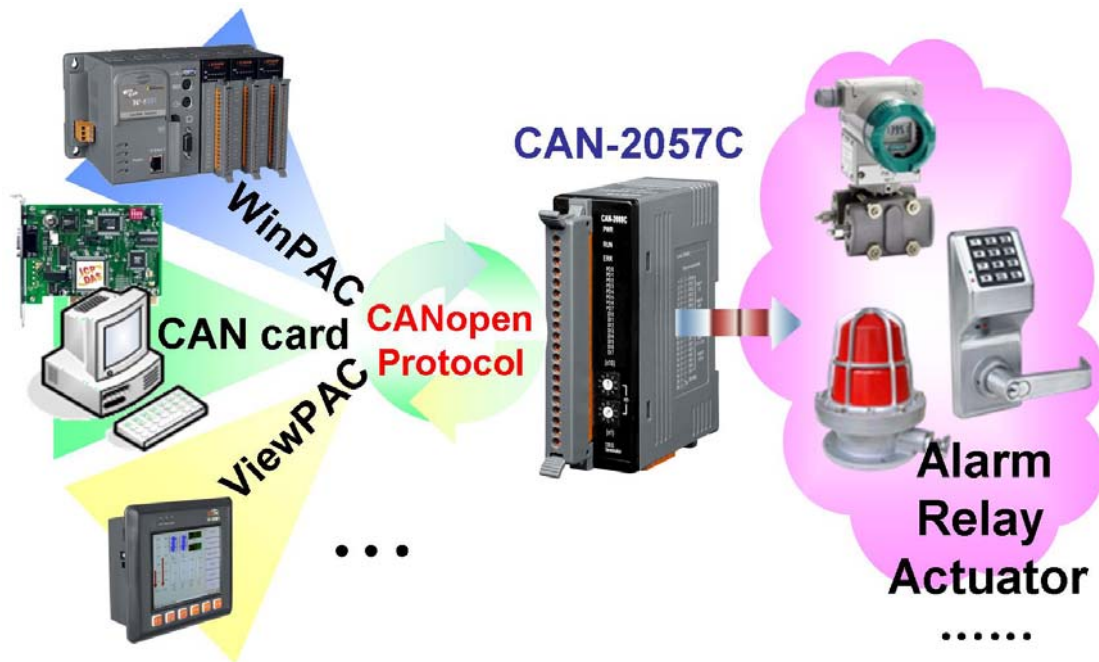

Figure 1-2 Application Structure

2 Hardware

2.1 Structure

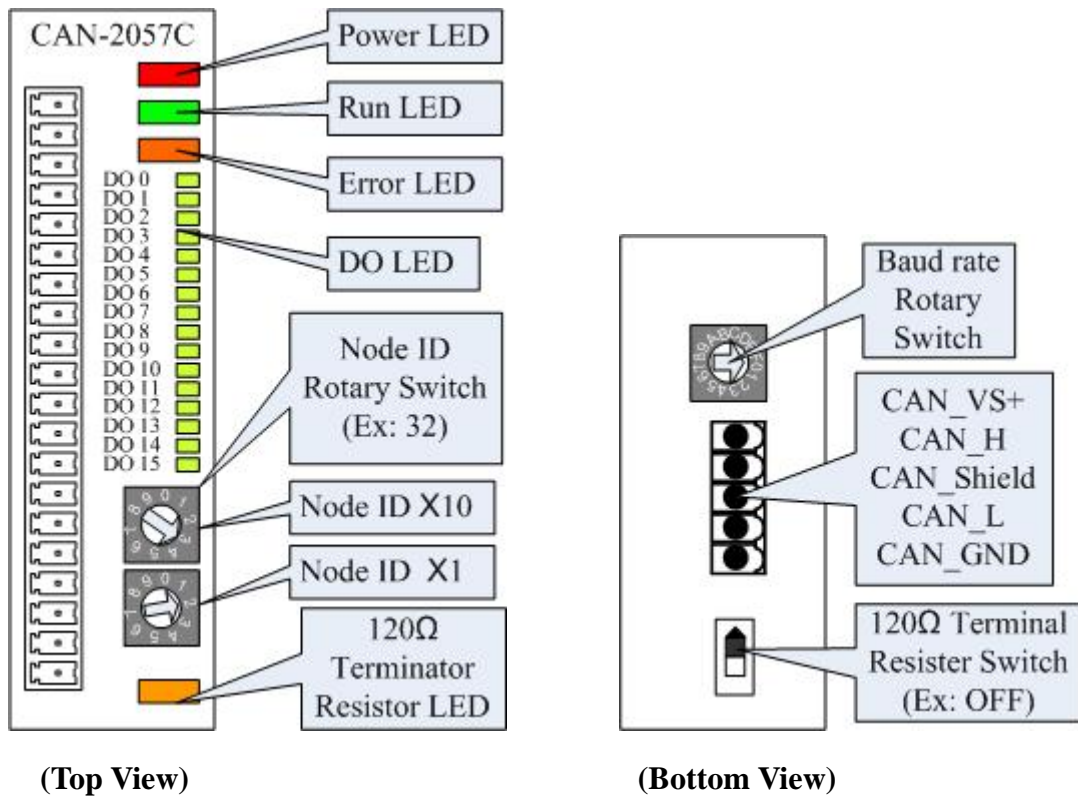

Figure 2-1 CAN-2057C layout of LED, connect, and switch

2.2 Node ID & Baud Rate Rotary Switch

The rotary switches of node ID configure the node ID of CAN-2057C module. These two switches are for the tens digit and the units digit of the node ID. The node ID value of this demo picture is 32.

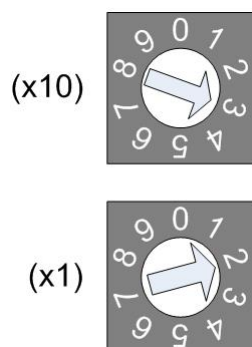

Figure 2-2 Node ID rotary switch

The rotary switch of baud rate handles the CAN baud rate of CAN-2057C module. The value of baud rate switch from 0 ~ 7 are normal CANopen mode, and 8 ~ F are I/O pair-connection mode. About the I/O pair-connection mode please refer to section 2.3. The relationship between the rotary switch value and the practical baud rate is presented in the following table.

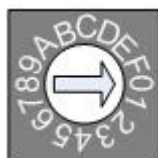

Figure 2-3 Baud rate rotary switch

Rotary Switch Value	Rotary Switch Value of I/O Pair-connection	Baud Rate (k bps)
0	8	10
1	9	20
2	A	50
3	B	125
4	C	250
5	D	500
6	E	800
7	F	1000

Table 2-1 Baud rate and rotary switch

2.3 I/O Pair-connection Mode

The CAN-2057C module provides the I/O pair-connection function. Before using this function, you need to prepare one CAN-2057C module and a 16-bit DI CAN-2000 series module (such as CAN-2053C). When applying this function, the DI channels of the CAN-2053C and the DO channels of the CAN-2057C are mapping with each other. That is to say that when the DI channels of the CAN-2053C get the ON signal, the corresponding DO channels of the CAN-2057C will be turned on.

When you completed the connection of the CAN-2053C and CAN2057C by CAN bus, you need to set the baud rate rotary switch of these two modules to 0x8 ~ 0xF, and configure the node ID of them by the special rule. Set the node ID to be odd for one module, and set the node ID of another module to be the value which is equal to the node ID increased one of the former. Therefore, they are the couple as the following figure.

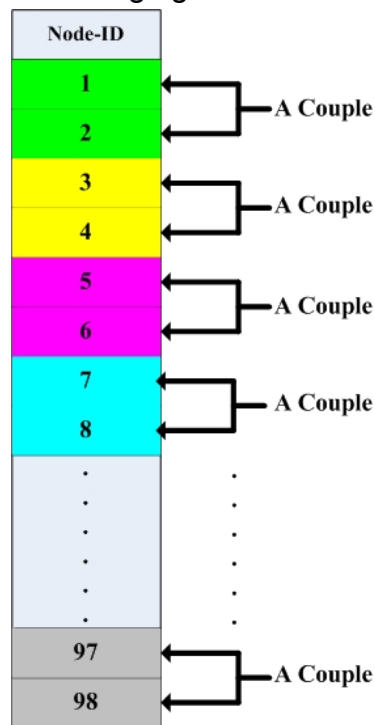

Figure 2-4 I/O pair-connection group structure

For example, user uses a CAN-2057C and a CAN-2053C to do I/O pair-connection. The connection structure is as follows.

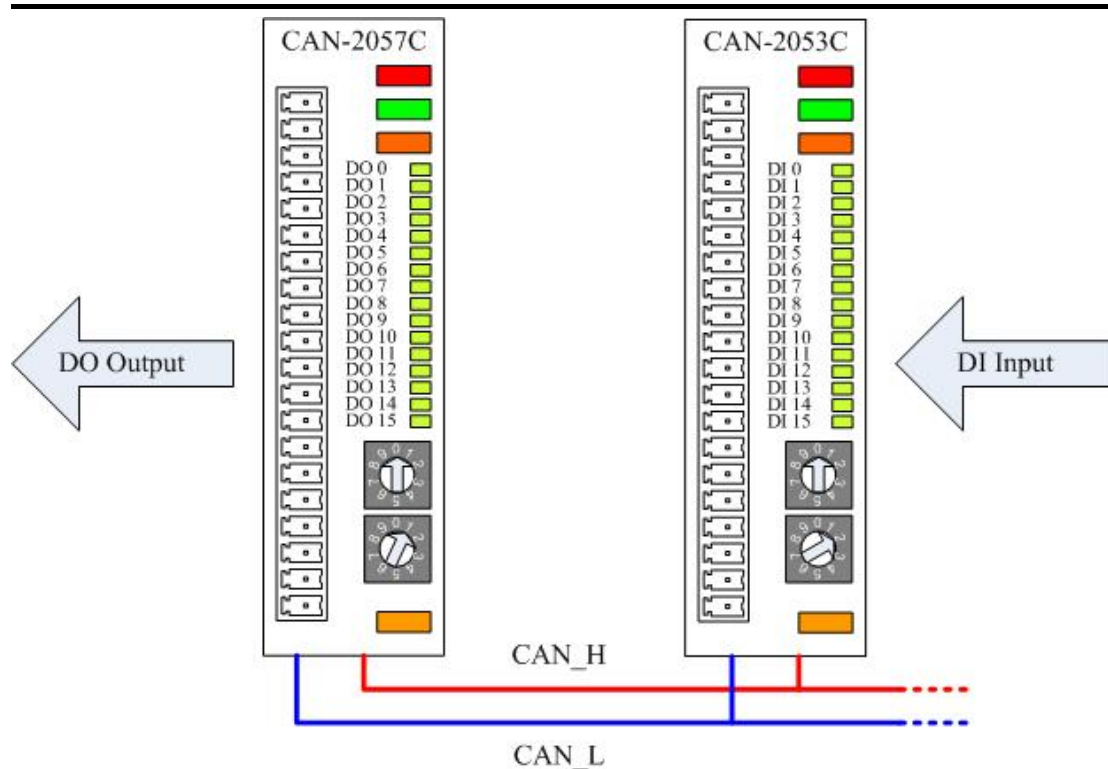

Figure 2-5 I/O pair-connection wire connect

The node ID of CAN-2057C is 1, and the node ID of CAN-2053C is 2. Both of these two module's baud rate switch are selected to "D", 500 kbps CANOpen baud rate with I/O pair-connection mode, and these two modules will into Operational state automatically. When the DI module, CAN-2053C, receives a DI ON-signal, the DO module, CAN-2057C, will output the ON-signal at the corresponding DO channels.

2.4 LED Description

Power LED

CAN-2057C allows 10 VDC ~ 30 VDC for working voltage. The power consumption is 1.5 W. Under the connection of a proper power connection, as the unit is turned on, the LED will light up in red.

Run LED

The Run LED indicates the CANopen operation state. The description of LED state is show below. About the detail, please refer to the section 2.3.1 of the CAN-2000C user manual.

LED Signal	State	Description
No Light	Non-operation	Power Supply is not ready
Single Flash	Stopped	The device is in Stopped state
Blinking	Pre-operational	Device is in Pre-operational state
Continuing Light	Operational	Device is in Operational state

Table 2-2 Run LED state description

Error LED

The Error LED indicates the CANopen error state. The description of LED state is show below. About the detail please refer to the section 2.3.2 of the CAN-2000C user manual.

LED Signal	State	Description
No Light	No error	Device is working well.
Single Flash	Error Warning	At least one CANopen error happened.
Double Flash	Guarding Fail	Guarding fail event happened.
Continuing Light	Bus Off	The bus off state happened.

Table 2-3 Err LED state description

Terminal Resistor LED

When enable the 120 Ω terminator resistor, the LED will turn on.

DO LED

If the DO LED turns on, it means that the corresponding DO channel sends an ON voltage-level digital signal no matter what the DO channel polarity is. (User can configure the 0x6202 object to change the polarity of the DO channel. More detail in section 3.3.)

2.5 PIN Assignment





















Terminal No.	Pin Assignment
 01	DO.0
 02	DO.1
 03	DO.2
 04	DO.3
 05	DO.4
 06	DO.5
 07	DO.6
 08	DO.7
 09	DO.8
 10	DO.9
 11	DO.10
 12	DO.11
 13	DO.12
 14	DO.13
 15	DO.14
 16	DO.15
 17	DO.GND
 18	DO.GND
 19	DO.PWR
 20	DO.PWR

Figure 2-6 CAN-2057C pin assignment

2.6 Wire Connection

Output Type	ON State LED ON Readback as 1	OFF State LED OFF Readback as 0
	Relay On	Relay Off
Drive Relay		
Resistance Load		

Figure 2-7 CAN-2057C Wire connection

3 Object Dictionary

3.1 Object List

General Communication Entries

Idx	Sidx	Description	Type	Attr	Default
1000h	0h	device type	UNSIGNED 32	RO	00020191h
1001h	0h	error register	UNSIGNED 8	RO	0h
1003h	0h	largest sub-index supported for "predefine error field"	UNSIGNED 8	RO	0h
	1h	actual error (the newest one)	UNSIGNED 32	RO	---
	---
	5h	actual error (the oldest one)	UNSIGNED 32	RO	---
1005h	0h	COB-ID of Sync message	UNSIGNED 32	RW	80h
1008h	0h	manufacturer device name	VISIBLE_STRING	RO	CAN-2057C
1009h	0h	manufacturer hardware version	VISIBLE_STRING	RO	1.0
100Ah	0h	manufacturer software version	VISIBLE_STRING	RO	1.00-20100310
100Ch	0h	guard time	UNSIGNED 16	RW	0h
100Dh	0h	life time factor	UNSIGNED 8	RW	0h
1010h	0h	largest sub-index supported for "store parameters"	UNSIGNED 8	RO	1h
1010h	1h	save all hardware parameter	UNSIGNED 32	RW	---
1011h	0h	largest sub-index supported for "restore default parameters"	UNSIGNED 8	RO	1h
1011h	1h	restore all default parameters	UNSIGNED 32	RW	---
1014h	0h	COB-ID of EMCY	UNSIGNED 32	RW	80h+x
1017h	0h	producer heartbeat time	UNSIGNED 16	RW	0
1018h	0h	largest sub-index supported for "identity object"	UNSIGNED 8	RO	4
	1h	vender ID	UNSIGNED 32	RO	---
	2h	product code	UNSIGNED 32	RO	---
	3h	revision number	UNSIGNED 32	RO	---
	4h	serial number	UNSIGNED 32	RO	---

Table 3-1 General object dictionary

Note: x is Node-ID of the module

SDO Communication Entries

Idx	Sidx	Description	Type	Attr	Default
1200h	0h	largest sub-index supported for “server SDO parameter”	UNSIGNED 8	RO	2
	1h	COB-ID form client to server (RxSDO)	UNSIGNED 32	RO	600h+x
	2h	COB-ID form server to client (TxSDO)	UNSIGNED 32	RO	580h+x

Table 3-2 SDO communication object dictionary

Note: x is Node-ID of the module

RxPDO Communication Entry

Idx	Sidx	Description	Type	Attr	Default
1400h	0h	Number of entries	UNSIGNED 8	RO	2
	1h	COB-ID used by RxPDO	UNSIGNED 32	RW	200h+x
	2h	Transmission type	UNSIGNED 8	RW	FFh
1401h	0h	Number of entries	UNSIGNED 8	RO	2
	1h	COB-ID used by RxPDO	UNSIGNED 32	RW	300h+x
	2h	Transmission type	UNSIGNED 8	RW	FFh
1402h	0h	Number of entries	UNSIGNED 8	RO	2
	1h	COB-ID used by RxPDO	UNSIGNED 32	RW	400h+x
	2h	Transmission type	UNSIGNED 8	RW	FFh
1403h	0h	Number of entries	UNSIGNED 8	RO	2
	1h	COB-ID used by RxPDO	UNSIGNED 32	RW	500h+x
	2h	Transmission type	UNSIGNED 8	RW	FFh
1404h	0h	Number of entries	UNSIGNED 8	RO	2
	1h	COB-ID used by RxPDO	UNSIGNED 32	RW	C000 0000h
	2h	Transmission type	UNSIGNED 8	RW	---
...
1409h	0h	Number of entries	UNSIGNED 8	RO	2
	1h	COB-ID used by RxPDO	UNSIGNED 32	RW	C000 0000h
	2h	Transmission type	UNSIGNED 8	RW	---

Table 3-3 RxPDO communication object dictionary

Note: x is Node-ID of the module

RxPDO Mapping Communication Entry

Idx	Sidx	Description	Type	Attr	Default
-----	------	-------------	------	------	---------

1600h	0h	Number of entries	UNSIGNED 8	RW	2
	1h	DO channel 0 ~ 7	UNSIGNED 32	RW	6200 0108h
	2h	DO channel 8 ~15	UNSIGNED 32	RW	6200 0208h
1601h	0h	Number of entries	UNSIGNED 8	RW	0
...
1609h	0h	Number of entries	UNSIGNED 8	RW	0

Table 3-4 RxPDO mapping object dictionary

TxPDO Communication Entry

Idx	Sidx	Description	Type	Attr	Default
1800h	0h	Number of entries	UNSIGNED 8	RO	5
	1h	COB-ID used by TxPDO	UNSIGNED 32	RW	180h+x
	2h	Transmission type	UNSIGNED 8	RW	FFh
	3h	Inhibit time	UNSIGNED 16		0
	4h	reversed	---	---	---
	5h	Event timer	UNSIGNED 16		0
1801h	0h	Number of entries	UNSIGNED 8	RO	5
	1h	COB-ID used by TxPDO	UNSIGNED 32	RW	280h+x
	2h	Transmission type	UNSIGNED 8	RW	FFh
	3h	Inhibit time	UNSIGNED 16		0
	4h	reversed	---	---	---
	5h	Event timer	UNSIGNED 16		0
1802h	0h	Number of entries	UNSIGNED 8	RO	5
	1h	COB-ID used by TxPDO	UNSIGNED 32	RW	380h+x
	2h	Transmission type	UNSIGNED 8	RW	FFh
	3h	Inhibit time	UNSIGNED 16		0
	4h	reversed	---	---	---
	5h	Event timer	UNSIGNED 16		0
1803h	0h	Number of entries	UNSIGNED 8	RO	5
	1h	COB-ID used by TxPDO	UNSIGNED 32	RW	480h+x
	2h	Transmission type	UNSIGNED 8	RW	FFh
	3h	Inhibit time	UNSIGNED 16		0
	4h	reversed	---	---	---
	5h	Event timer	UNSIGNED 16		0
1804h	0h	Number of entries	UNSIGNED 8	RO	5
	1h	COB-ID used by TxPDO	UNSIGNED 32	RW	8000 0000h
	2h	Transmission type	UNSIGNED 8	RW	---

	3h	Inhibit time	UNSIGNED 16		0
	4h	reversed	---	---	---
	5h	Event timer	UNSIGNED 16		0
...
1809h	0h	Number of entries	UNSIGNED 8	RO	5
	1h	COB-ID used by TxPDO	UNSIGNED 32	RW	8000 0000h
	2h	Transmission type	UNSIGNED 8	RW	---
	3h	Inhibit time	UNSIGNED 16		0
	4h	reversed	---	---	---
	5h	Event timer	UNSIGNED 16		0

Table 3-5 TxPDO communication object dictionary

Note: x is Node-ID of the module

TxPDO Mapping Communication Entry

Idx	Sidx	Description	Type	Attr	Default
1A00h	0h	Number of entries	UNSIGNED 8	RW	0
...
1A09h	0h	Number of entries	UNSIGNED 8	RW	0

Table 3-6 RxPDO mapping object dictionary

Power On Value Function

Idx	Sidx	Description	Type	Attr	Default
2010h	0h	Number of Output 8-Bit	UNSIGNED 8	RO	2
	1h	Set DO power on value of ch0 ~ ch7	UNSIGNED 8	RW	0
	2h	Set DO power on value of ch8 ~ ch15	UNSIGNED 8	RW	0

Table 3-7 Manufacturer object dictionary

Digital Output Function

Idx	Sidx	Description	Type	Attr	Default
6200h	0h	Number of Output 8-Bit	UNSIGNED 8	RO	2
	1h	DO value of ch0 ~ ch7	UNSIGNED 8	RW	0
	2h	DO value of ch8 ~ ch15	UNSIGNED 8	RW	0
6202h	0h	Number of Output 8-Bit	UNSIGNED 8	RO	2
	1h	Change polarity DO ch0 ~ ch7	UNSIGNED 8	RW	0
	2h	Change polarity DO ch8 ~ ch15	UNSIGNED 8	RW	0

6206h	0h	Number of Output 8-Bit	UNSIGNED 8	RO	2
	1h	Error mode DO ch0 ~ ch7	UNSIGNED 8	RW	0xFF
	2h	Error mode DO ch8 ~ ch15	UNSIGNED 8	RW	0xFF
6207h	0h	Number of Output 8-Bit	UNSIGNED 8	RO	2
	1h	Error value DO ch0 ~ ch7	UNSIGNED 8	RW	0
	2h	Error value DO ch8 ~ ch15	UNSIGNED 8	RW	0

Table 3-8 Application object dictionary

3.2 Store and Restore Object

User can write the value 0x65766173 to object index 0x1010 subindex 1 to save application setting, or write the value 0x64616F6C to object index 0x1011 subindex 1 and reboot the module to load the factory default. The following table lists the relative objects which will be stored or restored after writing these two commands. The factory default for these object is also be shown.

Index	Sub Index	Description	Factory Default
2010 h	1	Set digital output power on value for channel 8 ~ 15	0x00
2010 h	2	Set digital output power on value for channel 8 ~ 15	0x00
6202 h	1	Change polarity digital output for channel 0 ~ 7	0x00
6202 h	2	Change polarity digital output for channel 8 ~ 15	0x00
6206 h	1	Error mode digital output for channel 0 ~ 7	0xFF
6206 h	2	Error mode digital output for channel 8 ~ 15	0xFF
6207 h	1	Error value digital output for channel 0 ~ 7	0x00
6207 h	2	Error value digital output for channel 8 ~ 15	0x00

Table 3-8 Store and Restore the object list

3.3 Application Object

Digital Output module (0x6200)

User can set a group of 8 output lines as a byte of information and sent it into the object index 0x6200 with subindex 1 and 2 of CAN-2057C. For example, if the node id of CAN-2057C is 1, the commands are as below:

11-bit COB-ID (bit)											RTR	Data Length	8-byte Data (byte)							
Func Code				Node ID									0	1	2	3	4	5	6	7
10	9	8	7	6	5	4	3	2	1	0										
1	1	0	0	0	0	0	0	0	0	1	0	8	2F	00	62	01	37	00	00	00

SDO client → **SDO server (CAN-2057C)**

11-bit COB-ID (bit)											RTR	Data Length	8-byte Data (byte)							
Func Code				Node ID									0	1	2	3	4	5	6	7
10	9	8	7	6	5	4	3	2	1	0										
1	0	1	1	0	0	0	0	0	0	1	0	4	60	00	62	01	--	--	--	--

SDO client ← **SDO server (CAN-2057C)**

Write the 0x0F of digital output value into the object index 0x6200 with subindex 1, and its response success by CAN-2057C. The DO channels of DO5, DO4, DO2, DO1 and DO0 turn on and others are turn off.

Change Output Polarity (0x6202)

This object 0x6202 with subindex 1 and 2 define the polarity of a group of 8 output lines. Output polarity can be inverted individually.

1 = output inverted.

0 = output not inverted.

For example, if the node id of CAN-2057C is 1, the commands are as below:

11-bit COB-ID (bit)											RTR	Data Length	8-byte Data (byte)							
Func Code				Node ID									0	1	2	3	4	5	6	7
10	9	8	7	6	5	4	3	2	1	0										
1	1	0	0	0	0	0	0	0	0	1	0	8	2F	02	62	01	F0	00	00	00

SDO client → **SDO server (CAN-2057C)**

11-bit COB-ID (bit)											RTR	Data Length	8-byte Data (byte)							
Func Code				Node ID									0	1	2	3	4	5	6	7
10	9	8	7	6	5	4	3	2	1	0										
1	0	1	1	0	0	0	0	0	0	1	0	4	60	02	62	01	--	--	--	--

SDO client



**SDO server
(CAN-2057C)**

Write object index 0x6202 with subindex 1 to 0xF0 means that set the Ch0 ~ Ch3 of DO channels to normal, and set the Ch4 ~ Ch7 to be inverted.

Error Mode and Error Value (0x6206, 0x6207)

The object 0x6206 and 0x6207 are used to control the safe value when error happens. When some error event of this module happens such as node guarding failure, the module will check the value of the object 0x6206. If some bits of this value are set to 1, the corresponding DO channels will be into the error mode output. The error mode output values are concerned to the object 0x6207. For example, if the subindex 01 in the object with 0x6206 and 0x6207 are 0x31 and 0xF8 respectively, when some error event occurs, only the DO5, DO4, DO0 will be changed to error mode output because the bit 5, bit 4, and bit 0 of the value 0x31 is 1. The others channels keeps the status as the error event is not happened. The bit 5, bit 4, and bit 0 of the value 0xF8 are 1, 1 and 0, therefore the error mode output value of DO5, DO4 and DO0 are active, active, and inactive respectively.

11-bit COB-ID (bit)											RTR	Data Length	8-byte Data (byte)							
Func Code				Node ID									0	1	2	3	4	5	6	7
10	9	8	7	6	5	4	3	2	1	0										
1	1	0	0	0	0	0	0	0	0	1	0	8	2F	06	62	01	31	00	00	00

SDO client



**SDO server
(CAN-2057C)**

11-bit COB-ID (bit)											RTR	Data Length	8-byte Data (byte)							
Func Code				Node ID									0	1	2	3	4	5	6	7
10	9	8	7	6	5	4	3	2	1	0										
1	0	1	1	0	0	0	0	0	0	1	0	8	60	06	62	01	--	--	--	--

SDO client



**SDO server
(CAN-2057C)**

Write object index 0x6206 and subindex 1 to 0x31 means set the error mode to 0x31 for enabling the error mode output of DO 0, DO 4 and DO5.

11-bit COB-ID (bit)											RTR	Data Length	8-byte Data (byte)							
Func Code				Node ID									0	1	2	3	4	5	6	7
10	9	8	7	6	5	4	3	2	1	0			0	1	2	3	4	5	6	7
1	1	0	0	0	0	0	0	0	0	1	0	8	2F	07	62	01	F8	00	00	00

SDO client



**SDO server
(CAN-2057C)**

11-bit COB-ID (bit)											RTR	Data Length	8-byte Data (byte)							
Func Code				Node ID									0	1	2	3	4	5	6	7
10	9	8	7	6	5	4	3	2	1	0			0	1	2	3	4	5	6	7
1	0	1	1	0	0	0	0	0	0	1	0	8	60	07	62	01	--	--	--	--

SDO client



**SDO server
(CAN-2057C)**

Write object index 0x6207 and subindex 1 to 0xF8 means set the error value to 0xF8 for activating the error mode output value of DO 3 ~ DO 7. If the error event in this module, the module will output the safe value 0x30 (0x31 & 0xF8 = 0x30) corresponding the object 0x6206 and 0x6207.

Set Power On Value (0x2010)

This object 0x2010 with subindex 1 and 2 define the power on value of a group of 8 output lines. Power on value can be set individually.

For example, if the node id of CAN-2057C is 1, the commands are as below:

11-bit COB-ID (bit)											RTR	Data Length	8-byte Data (byte)							
Func Code				Node ID									0	1	2	3	4	5	6	7
10	9	8	7	6	5	4	3	2	1	0			0	1	2	3	4	5	6	7
1	1	0	0	0	0	0	0	0	0	1	0	8	2F	10	20	01	F0	00	00	00

SDO client



**SDO server
(CAN-2057C)**

11-bit COB-ID (bit)											RTR	Data Length	8-byte Data (byte)							
Func Code				Node ID									0	1	2	3	4	5	6	7
10	9	8	7	6	5	4	3	2	1	0			0	1	2	3	4	5	6	7
1	0	1	1	0	0	0	0	0	0	1	0	4	60	10	20	01	--	--	--	--

SDO client



**SDO server
(CAN-2057C)**

Write object index 0x2010 with subindex 1 to 0xF0 means that set the Ch0 ~ Ch3 of DO channels to 0, and set the Ch4 ~ Ch7 to 1 when the CAN-2057C power on.

3.4 Default PDO Mapping

RxPDO mapping list:

ID	Len	D 0	D 1
0x200 + x	2	DO 0 ~ DO 7	DO 8 ~ DO 15

Table 3-9 Default RxPDO list

Note: x is Node-ID of the module