CANopen Slave Device

CAN-2088C

Application User's Manual

Warranty

Without contrived damage, all products manufactured by ICP DAS are warranted in one year from the date of delivery to customers.

Warning

ICP DAS revises the manual at any time without notice. However, no responsibility is taken by ICP DAS unless infringement act imperils to patents of the third parties.

Copyright

Copyright © 2009 is reserved by ICP DAS.

Trademark

The brand name ICP DAS as a trademark is registered, and can be used by other authorized companies.

Contents

1	Introduction.....	3
1.1	Overview.....	3
1.2	Hardware Specifications	4
1.3	Features.....	5
1.4	Application	6
2	Hardware	7
2.1	Structure.....	7
2.2	Node ID & Baud Rate Rotary Switch	8
2.3	LED Description.....	9
2.4	PIN Assignment	10
2.5	Wire Connection	11
3	Application	12
3.1	Object Dictionary	12
3.2	Store and Restore Object.....	19
3.3	Application Object.....	20
3.4	Default PDO Mapping	23

1 Introduction

1.1 Overview

PWM (Pulse width modulation) is a powerful technique for controlling analog circuits. It uses digital outputs to generate a waveform with variant duty cycle and frequency to control analog circuits. CAN-2088C is a CANopen slave module and it has 8 PWM output channels and 8 digital inputs. It can be used to develop powerful and cost effective analog control system.



Figure 1-1 CAN-2088C

1.2 Hardware Specifications

PWM Output:

- Output Channels: 8 (Source)
- Scaling Resolution: 16-bit (1 ~ 128 μ s for each step).
- Frequency Range: 0.2 Hz ~ 500 kHz (non-continuous, and the min. unit of the high/low level of the signal is 1 μ s).
- Duty Cycle: 0.1% ~ 99.9%.
- PWM Mode: Burst Counting, Continuous mode.
- Burst Counter: 1 ~ 65535.
- Trigger Mode: Hardware or software trigger.
- Hardware Trigger Mode: Trigger start & trigger stop.
- Max Load Current: 1 mA.
- Intra-module Isolation, Field to Logic: 2500 Vrms.
- ESD Protection: 4 kV Contact for each channel.

Digital Input:

- Input Channels: 8 (Sink).
- Input Type: One common for all digital input.
- On Voltage Level: +5.5 ~ +30 V.
- Off Voltage Level: <+3.5 V.
- Counter Frequency: 500 kHz Max.
- Max. Counts: 32-bit (0 ~ 4294967295)
- Input Impedance: 2.2 k Ω , 0.5 W
- Intra-module Isolation, Field to Logic: 2500 Vrms
- ESD Protection: 4 kV Contact for each channel

Others:

- LED: 1 as power indicator, 1 as terminator resistor, 2 as CANopen status, 8 as PWM and 8 as DI indicator.
- Power Requirement: +10 ~ +30 V_{DC}, 3.5 W.
- Operating Temperature: -25 ~ +75 $^{\circ}$ C.
- Storage Temperature: -30 ~ +80 $^{\circ}$ C.
- Humidity: 10 to 90% RH, Non-condensing.
- Dimensions: 32.3 mm x 99 mm x 77.5 mm (W x L x H) Detail.

1.3 Features

- Standard CANopen general I/O slave devices.
- Provide EDS file for master interface.
- Automatic generation of PWM outputs by hardware, without software intervention.
- 0.2 Hz ~ 500 kHz (non-continuous) PWM output frequency with 0.1%~99.9% duty cycle configuration.
- Software and hardware trigger mode for PWM output.
- Support individual or synchronous PWM output in software trigger mode.
- Support acceleration and deceleration with 0.1 pulse per ms.
- Each digital input channel provides high-speed counter functionality.
- DI channel can be configured as simple digital input channel or hardware trigger source of the PWM output.

1.4 Application

- Controlling the position/speed of motors
- Dimming the brightness of lamps
- Controlling the speed of fans
- High speed counter

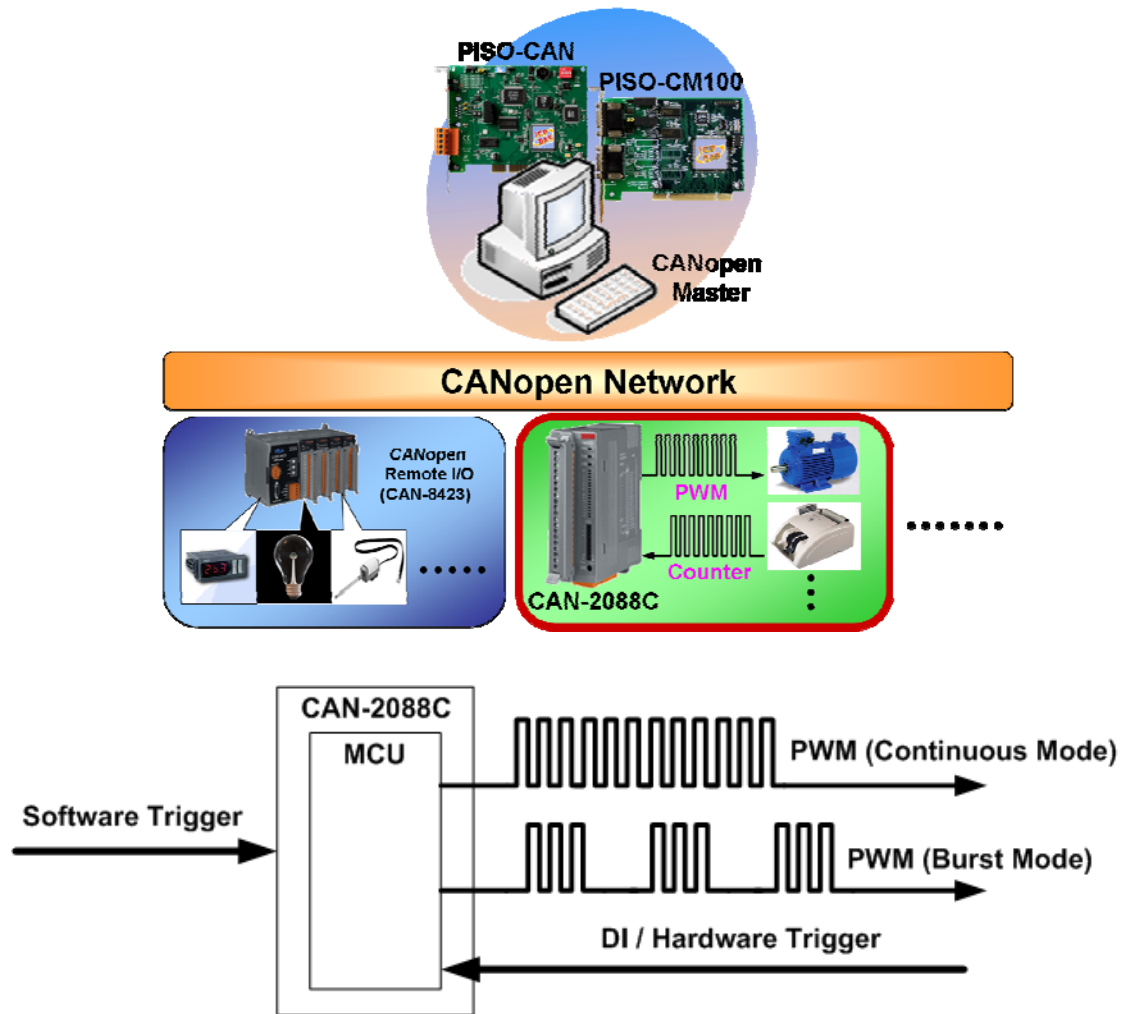

Figure 1-2 Application Structure

2 Hardware

2.1 Structure

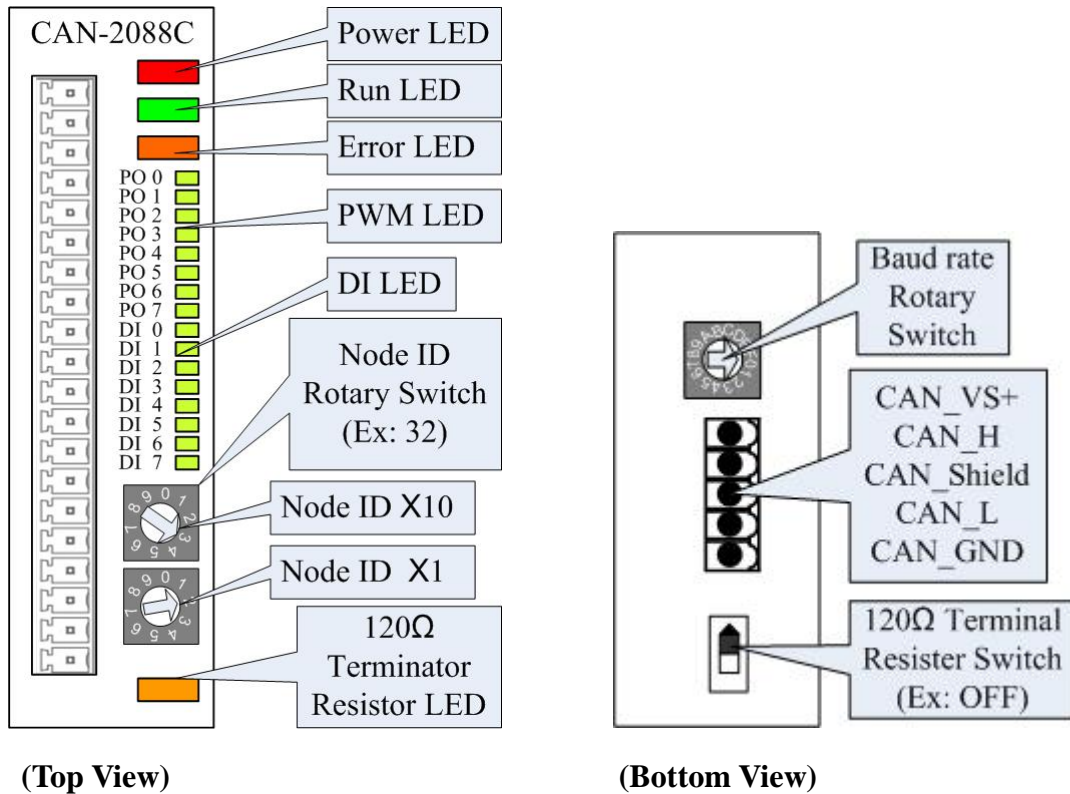

Figure 2-1 CAN-2088C layout of LED, connect, and switch

2.2 Node ID & Baud Rate Rotary Switch

The rotary switches for node ID configure the node ID of CAN-2000C module. These two switches are for the tens digit and the units digit of node ID. The node ID value of this demo picture is 32.

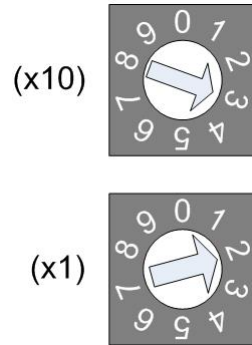

Figure 2-2 Node ID rotary switch

The rotary switch for baud rate handles the CAN baud rate of CAN-2000C module. The relationship between the rotary switch value and the practical baud rate is presented in the following table.



Figure 2-3 Baud rate rotary switch

Rotary Switch Value	Baud rate (k BPS)
0	10
1	20
2	50
3	125
4	250
5	500
6	800
7	1000

Table 2-1 Baud rate and rotary switch

2.3 LED Description

Power LED

The CAN-2088C needs 10 to 30 VDC power supplies. Under a normal connection, a good power supply and a correct voltage selection, as the unit is turned on, the LED will light up in red.

Run LED

The Run LED indicates the CANopen operation state. The description of LED state is show below. About the detail, please refer to the section 2.3.1 of the CAN-2000C user manual.

LED Signal	State	Description
No Light	Non-operation	Power Supply not ready
Single Flash	Stopped	The device is in Stopped state
Blinking	Pre-operation	Device is in pre-operational state
Continuing Light	Operation	Device is in operational state

Table 2-2 Run LED state description

Error LED

The Error LED indicates the CANopen error state. The description of LED state is show below. About the detail please refer to the section 2.3.2 of the CAN-2000C user manual.

LED Signal	State	Description
No Light	No error	Device is in working condition.
Single Flash	Error Warning	At least one error of the CAN controller has occurred.
Double Flash	Guarding fail.	Guard event happened.
Continuing Light	Bus Off	The CAN controller is bus off.

Table 2-3 Err LED state description

Terminal Resistor LED

When enable the 120Ω terminal resistor, the LED will turn on.

PWM LED

If the PWM LED turns on, it means that the channel of PWM is sending pulse.

DI LED

If the DI LED turns on, it means that the channel of DI is receiving an ON-Voltage-Level digital signal.

2.4 PIN Assignment





















Terminal No.	Pin Assignment
 01	PO.0
 02	PO.1
 03	PO.2
 04	PO.3
 05	PO.4
 06	PO.5
 07	PO.6
 08	PO.7
 09	PO.GND
 10	PO.GND
 11	DI.0
 12	DI.1
 13	DI.2
 14	DI.3
 15	DI.4
 16	DI.5
 17	DI.6
 18	DI.7
 19	DI.GND
 20	DI.GND

Figure 2-4 CAN-2088C pin assignment

2.5 Wire Connection

Output Type	ON State LED ON Readback as 1	OFF State LED OFF Readback as 0
Drive Relay	Relay On 	Relay Off 
	Resistance Load 	Resistance Load 

Input Type	ON State LED ON Readback as 1	OFF State LED OFF Readback as 0
Relay Contact	Relay On 	Relay Off 
	TTL/CMOS Logic Voltage > 10 V 	TTL/CMOS Logic Voltage < 4 V 
NPN Output	Open Collector On 	Open Collector Off 
	PNP Output	Open Collector On 

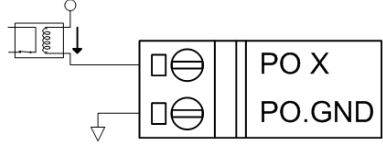
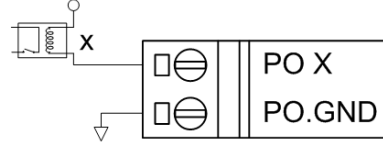
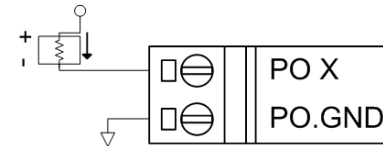
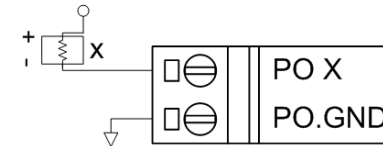
Figure 2-5 CAN-2088C Wire connection

3 Application

3.1 Object Dictionary

General Communication Entries

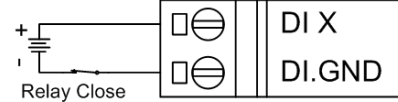
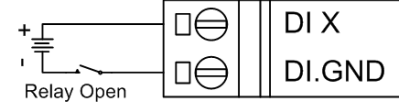
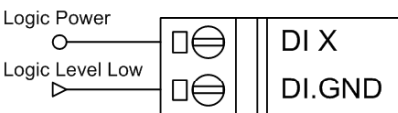
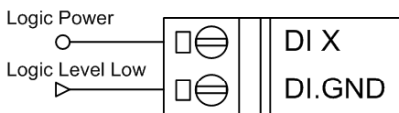
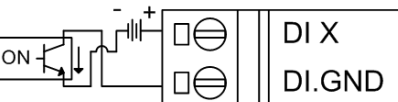
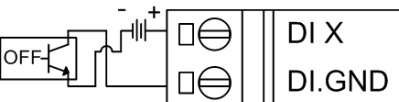
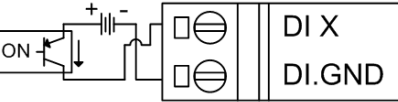
Idx	Sidx	Description	Type	Attr	Default
1000h	0h	device type	UNSIGNED 32	RO	00200191h
1001h	0h	error register	UNSIGNED 8	RO	0h
1003h	0h	largest sub-index supported for "predefine error field"	UNSIGNED 8	RO	0h
	1h	actual error (the newest one)	UNSIGNED 32	RO	---
	---
	5h	actual error (the oldest one)	UNSIGNED 32	RO	---
1005h	0h	COB-ID of Sync message	UNSIGNED 32	RW	80h
1008h	0h	manufacturer device name	VISIBLE_STRING	RO	CAN-2088
1009h	0h	manufacturer hardware version	VISIBLE_STRING	RO	02
100Ah	0h	manufacturer software version	VISIBLE_STRING	RO	1.00-20090831
100Ch	0h	guard time	UNSIGNED 16	RW	0h
100Dh	0h	life time factor	UNSIGNED 8	RW	0h
1010h	0h	largest sub-index supported for "store parameters"	UNSIGNED 8	RO	1h
1010h	1h	save all hardware parameter	UNSIGNED 32	RW	---
1011h	0h	largest sub-index supported for "restore default parameters"	UNSIGNED 8	RO	1h
1011h	1h	restore all default parameters	UNSIGNED 32	RW	---
1014h	0h	COB-ID of EMCY	UNSIGNED 32	RW	80h+x
1017h	0h	producer heartbeat time	UNSIGNED 16	RW	0
1018h	0h	largest sub-index supported for "identity object"	UNSIGNED 8	RO	4
	1h	vender ID	UNSIGNED 32	RO	---
	2h	product code	UNSIGNED 32	RO	---
	3h	revision number	UNSIGNED 32	RO	---
	4h	serial number	UNSIGNED 32	RO	---

Table 3-1 General object dictionary

Note: x is Node-ID of the module

SDO Communication Entries

Idx	Sidx	Description	Type	Attr	Default
1200h	0h	largest sub-index supported for “server SDO parameter”	UNSIGNED 8	RO	2
	1h	COB-ID form client to server (RxSDO)	UNSIGNED 32	RO	600h+x
	2h	COB-ID form server to client (TxSDO)	UNSIGNED 32	RO	580h+x

Table 3-2 SDO communication object dictionary

Note: x is Node-ID of the module

Type Code

Idx	Sidx	Description	Type	Attr	Default
2004h	0h	Number of entries	UNSIGNED 8	RO	8
	1h	PWM mode for channel 0	UNSIGNED 8	RW	1
	---	---	---	---	---
	8h	PWM mode for channel 7	UNSIGNED 8	RW	1

Type Code	Parameter Description
0	Burst Counting Mode
1 (default)	Continue Mode

Table 3-3 CAN-2088C type object dictionary

Counter Input Function

Idx	Sidx	Description	Type	Attr	Default
3000h	0h	Number of entries	UNSIGNED 8	RO	8
	1h	High speed counter with ch0	UNSIGNED 32	RO	0
	---	---	---	---	---
	8h	High speed counter with ch7	UNSIGNED 32	RO	0
3002h	0h	Number of entries	UNSIGNED 8	RO	8
	1h	Clear counter with ch0	UNSIGNED 8	WO	0
	---	---	---	---	---
	8h	Clear counter with ch7	UNSIGNED 8	WO	0

Object	Range	Parameter Description
3000h	UNSIGNED 32	Read counter of DI channel.
3002h	0x01: clear counter	Clear the counter of DI channel.

Table 3-4 Counter application object dictionary

PWM Output Function

Idx	Sidx	Description	Type	Attr	Default
3100h	0h	Number of entries	UNSIGNED 8	RO	8
	1h	Start to output pulse with ch0	UNSIGNED 8	RW	0
	---	---	---	---	---
	8h	Start to output pulse with ch7	UNSIGNED 8	RW	0
3101h	0h	Number of entries	UNSIGNED 8	RO	8
	1h	Set burst counting with ch0	UNSIGNED 16	RW	0
	---	---	---	---	---
	8h	Set burst counting with ch7	UNSIGNED 16	RW	0
3102h	0h	Number of entries	UNSIGNED 8	RO	8
	1h	Set output frequency with ch0	UNSIGNED 32	RW	2
	---	---	---	---	---
	8h	Set output frequency with ch7	UNSIGNED 32	RW	2
3103h	0h	Number of entries	UNSIGNED 8	RO	8
	1h	Set pulse duty with ch0	UNSIGNED 16	RW	500
	---	---	---	---	---
	8h	Set pulse duty with ch7	UNSIGNED 16	RW	500
3104h	0h	Number of entries	UNSIGNED 8	RO	8
	1h	Set hardware trig with ch0	UNSIGNED 8	RW	0
	---	---	---	---	---
	8h	Set DI to hardware trig with ch7	UNSIGNED 8	RW	0
3105h	0h	Number of entries	UNSIGNED 8	RO	8
	1h	Set sync channel with ch0	UNSIGNED 8	RW	0
	---	---	---	---	---
	8h	Set sync channel with ch7	UNSIGNED 8	RW	0
3106h	0h	Number of entries	UNSIGNED 8	RO	1
	1h	Start sync pulse with the channel of enabled sync setting	UNSIGNED 8	RW	0
3110h	0h	Number of entries	UNSIGNED 8	RO	8
	1h	Set deceleration with ch0	UNSIGNED 16	RW	0
	---	---	---	---	---
	8h	Set deceleration with ch7	UNSIGNED 16	RW	0
3111h	0h	Number of entries	UNSIGNED 8	RO	8
	1h	Set acceleration with ch0	UNSIGNED 16	RW	0
	---	---	---	---	---

	8h	Set acceleration with ch7	UNSIGNED 16	RW	0
3112h	0h	Number of entries	UNSIGNED 8	RO	8
	1h	Set channel group with ch0	UNSIGNED 8	RW	0
	---	---	---	---	---
	8h	Set channel group with ch7	UNSIGNED 8	RW	0

Object	Range	Parameter Description
3100h	0x00: stop output 0x01: start output 0x80: stop with deceleration 0x81: start with acceleration	Start or stop to output pulse. If the deceleration or acceleration is 0, the 0x80 is equal to 0x00 and 0x81 is equal to 0x01.
3101h	1 ~ 65535	The object is only for Burst counting mode.
3102h	2 ~ 5000000 (0.2 Hz ~ 500 kHz)	The frequency range is non-continuous.
3103h	1 ~ 999 (1‰ ~ 999‰)	The object is high duty mille. low duty mille = (1000 – high duty) ‰
3104h	0: disable 1: start trig 2: stop trig	The DI ch0 is the trig of PO ch0, and DI ch1 is the trig of PO ch1, and so on. When DI value is changed, the PO will be triggered.
3105h	0: disable sync 1: enable sync	Set the PO channel with sync output.
3106h	0: stop sync output 1: start sync output	If PO ch0, ch2, and ch5 are enabled sync output. These three channels will output at the same time when 3106h object is set to 1.
3110h	0 ~ 65535 0.1 Hz/ms (deceleration)	When user set object 0x3100 with 0x80 and if the object 0x3110 is not equal to 0, the frequency of output pulse will decreased with deceleration until 0.
3111h	0 ~ 65535 0.1 Hz/ms (acceleration)	When user set object 0x3100 with 0x81 and if the object 0x3111 is not equal to 0, the frequency of output pulse will increased with acceleration until the setting of object 0x3102.
3112h	0: none group 1: group channel (not for sync output	Per group has two PO channels, and only one channel can output pulse at the same time. The group setting is that, ch0-ch1, ch2-ch3, and so on. So no matter ch0 or ch1 is set to 1

	and hardware trig)	in group 1, the object of another channel will also be set to 1.
--	---------------------------	--

Table 3-5 PWM application object dictionary

Digital Input Function

Idx	Sidx	Description	Type	Attr	Default
6000h	0h	Number of entries	UNSIGNED 8	RO	1
	1h	DI value of ch0 ~ ch7	UNSIGNED 8	RO	0

Table 3-6 DI application object dictionary

RxPDO Communication Entry

Idx	Sidx	Description	Type	Attr	Default
1400h	0h	Number of entries	UNSIGNED 8	RO	2
	1h	COB-ID used by RxPDO	UNSIGNED 32	RW	200h+x
	2h	Transmission type	UNSIGNED 8	RW	FFh
1401h	0h	Number of entries	UNSIGNED 8	RO	2
	1h	COB-ID used by RxPDO	UNSIGNED 32	RW	300h+x
	2h	Transmission type	UNSIGNED 8	RW	FFh
1402h	0h	Number of entries	UNSIGNED 8	RO	2
	1h	COB-ID used by RxPDO	UNSIGNED 32	RW	400h+x
	2h	Transmission type	UNSIGNED 8	RW	FFh
1403h	0h	Number of entries	UNSIGNED 8	RO	2
	1h	COB-ID used by RxPDO	UNSIGNED 32	RW	500h+x
	2h	Transmission type	UNSIGNED 8	RW	FFh
1404h	0h	Number of entries	UNSIGNED 8	RO	2
	1h	COB-ID used by RxPDO	UNSIGNED 32	RW	8000 0000h
	2h	Transmission type	UNSIGNED 8	RW	---
...
1409h	0h	Number of entries	UNSIGNED 8	RO	2
	1h	COB-ID used by RxPDO	UNSIGNED 32	RW	8000 0000h
	2h	Transmission type	UNSIGNED 8	RW	---

Table 3-7 RxPDO communication object dictionary

Note: x is Node-ID of the module

RxPDO Mapping Communication Entry

Idx	Sidx	Description	Type	Attr	Default
1600h	0h	Number of entries	UNSIGNED 8	RW	8

	1h	PWM channel 0	UNSIGNED 32	RW	3100 0108h

	8h	PWM channel 7	UNSIGNED 32	RW	3100 0808h
1601h	0h	Number of entries	UNSIGNED 8	RW	0
1602h	0h	Number of entries	UNSIGNED 8	RW	0
1603h	0h	Number of entries	UNSIGNED 8	RW	0
1604h	0h	Number of entries	UNSIGNED 8	RW	8
	1h	Clear counter channel 0	UNSIGNED 32	RW	3002 0108h

	8h	Clear counter channel 7	UNSIGNED 32	RW	3002 0808h
1605h	0h	Number of entries	UNSIGNED 8	RW	0
...
1609h	0h	Number of entries	UNSIGNED 8	RW	0

Table 3-8 RxPDO mapping object dictionary

TxPDO Communication Entry

Idx	Sidx	Description	Type	Attr	Default
1800h	0h	Number of entries	UNSIGNED 8	RO	5
	1h	COB-ID used by TxPDO	UNSIGNED 32	RW	180h+x
	2h	Transmission type	UNSIGNED 8	RW	FFh
	3h	Inhibit time	UNSIGNED 16		0
	4h	reversed	---	---	---
	5h	Event timer	UNSIGNED 16		0
1801h	0h	Number of entries	UNSIGNED 8	RO	5
	1h	COB-ID used by TxPDO	UNSIGNED 32	RW	280h+x
	2h	Transmission type	UNSIGNED 8	RW	FFh
	3h	Inhibit time	UNSIGNED 16		0
	4h	reversed	---	---	---
	5h	Event timer	UNSIGNED 16		0
1802h	0h	Number of entries	UNSIGNED 8	RO	5
	1h	COB-ID used by TxPDO	UNSIGNED 32	RW	380h+x
	2h	Transmission type	UNSIGNED 8	RW	FFh
	3h	Inhibit time	UNSIGNED 16		0
	4h	reversed	---	---	---
	5h	Event timer	UNSIGNED 16		0
1803h	0h	Number of entries	UNSIGNED 8	RO	5
	1h	COB-ID used by TxPDO	UNSIGNED 32	RW	480h+x

	2h	Transmission type	UNSIGNED 8	RW	FFh
	3h	Inhibit time	UNSIGNED 16		0
	4h	reversed	---	---	---
	5h	Event timer	UNSIGNED 16		0
1804h	0h	Number of entries	UNSIGNED 8	RO	5
	1h	COB-ID used by TxPDO	UNSIGNED 32	RW	8000 0000h
	2h	Transmission type	UNSIGNED 8	RW	---
	3h	Inhibit time	UNSIGNED 16		0
	4h	reversed	---	---	---
	5h	Event timer	UNSIGNED 16		0
...
1809h	0h	Number of entries	UNSIGNED 8	RO	5
	1h	COB-ID used by TxPDO	UNSIGNED 32	RW	8000 0000h
	2h	Transmission type	UNSIGNED 8	RW	---
	3h	Inhibit time	UNSIGNED 16		0
	4h	reversed	---	---	---
	5h	Event timer	UNSIGNED 16		0

Table 3-9 TxPDO communication object dictionary

Note: x is Node-ID of the module

TxPDO Mapping Communication Entry

Idx	Sidx	Description	Type	Attr	Default
1A00h	0h	Number of entries	UNSIGNED 8	RO	1
	1h	DI channel 0 ~ 7	UNSIGNED 32	RW	6000 0108h
1A01h	0h	Number of entries	UNSIGNED 8	RO	2
	1h	DI counter channel 0	UNSIGNED 32	RW	3000 0108h
	2h	DI counter channel 1	UNSIGNED 32	RW	3000 0208h
1A02h	0h	Number of entries	UNSIGNED 8	RO	0
	1h	DI counter channel 2	UNSIGNED 32	RW	3000 0308h
	2h	DI counter channel 3	UNSIGNED 32	RW	3000 0408h
1A03h	0h	Number of entries	UNSIGNED 8	RO	0
	1h	DI counter channel 4	UNSIGNED 32	RW	3000 0508h
	2h	DI counter channel 5	UNSIGNED 32	RW	3000 0608h
1A04h	0h	Number of entries	UNSIGNED 8	RO	0
	1h	DI counter channel 6	UNSIGNED 32	RW	3000 0708h
	2h	DI counter channel 7	UNSIGNED 32	RW	3000 0808h
1A05h	0h	Number of entries	UNSIGNED 8	RO	0

...
1A09h	0h	Number of entries	UNSIGNED 8	RO	0

Table 3-10 RxPDO mapping object dictionary

3.2 Store and Restore Object

User can write the value 0x65766173 to object index 0x1010 subindex 1 to save application setting, or write the value 0x64616F6C to object index 0x1011 subindex 1 and reboot the module to load the factory default. The following table lists the relative objects which will be stored or restored after writing these two commands. The factory default for these object is also be shown.

Index	Sub Index	Description	Factory Default
2004 h	1 ~ 8	PWM mode for channel 1 ~ channel 8	1
3101 h	1 ~ 8	Start to output pulse with channel 0 ~ channel 7	0
3102 h	1 ~ 8	Set burst counting with channel 0 ~ channel 7	0
3103 h	1 ~ 8	Set output frequency with channel 0 ~ channel 7	2
3104 h	1 ~ 8	Set pulse duty with channel 0 ~ channel 7	500
3105 h	1 ~ 8	Set hardware trig with channel 0 ~ channel 7	0
3110 h	1 ~ 8	Set sync channel with channel 0 ~ channel 7	0
3111 h	1 ~ 8	Set deceleration with channel 0 ~ channel 7	0
3112 h	1 ~ 8	Set acceleration with channel 0 ~ channel 7	0

Table 3-11 Store and Restore the object list

3.3 Application Object

User can read the object index 0x3000 subindex 1 ~ 8 to get the counter of 1 ~ 8 channel, and the range of counter value is 0 ~ 4294967295. If user wants to clear the counter, user can write 1 to the object index 0x3002 subindex 1 ~ 8 and the counter value of the channel will be clear to 0.

Because the 4 default TxPDO objects of CANopen communication isn't enough to map counter object. The counter channel 6 and 7 will be mapping in the 5th TxPDO object, 0x1A04. So when user wants to use the counter channel 6 and 7 with PDO protocol, user must to set the new PDO COBID in index 0x1804 subindex 1 for this object. For example, if the node id of CAN-2088C is 1, like below:

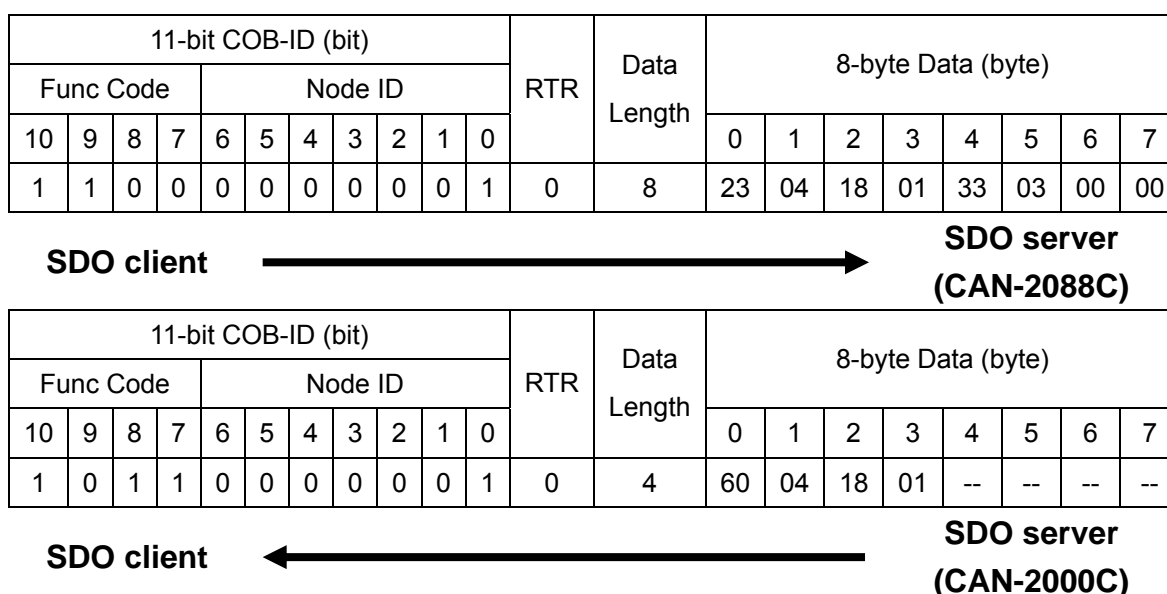

Write object index 0x1804 and subindex 1 to 0x333 means set the new COBID 0x333 to 5th TxPDO. To do this, the counter channel 6 and 7 will be mapping in the new PDO COBID 0x333. So user can use 0x333 COBID to remote the counter channel 6 and 7 data.

The “Clear Counter” object had mapping in 5th RxPDO, 0x1604. So when user wants to use the clear counter object with PDO protocol, user must to set the new PDO COBID in index 0x1404 subindex 1 for this object. For example, if the node id of CAN-2088C is 1, like below:

11-bit COB-ID (bit)											RTR	Data Length	8-byte Data (byte)							
Func Code				Node ID																
10	9	8	7	6	5	4	3	2	1	0			0	1	2	3	4	5	6	7
1	1	0	0	0	0	0	0	0	0	1	0	8	23	04	14	01	22	02	00	00

SDO client



**SDO server
(CAN-2088C)**

11-bit COB-ID (bit)											RTR	Data Length	8-byte Data (byte)							
Func Code				Node ID																
10	9	8	7	6	5	4	3	2	1	0			0	1	2	3	4	5	6	7
1	0	1	1	0	0	0	0	0	0	1	0	4	60	04	14	01	--	--	--	--

SDO client



**SDO server
(CAN-2000C)**

Write object index 0x1404 and subindex 1 to 0x222 means set the new COBID 0x222 to 5th RxPDO. To do this, the clear counter function will be mapping in the new PDO COBID 0x222. So user can write 1 for byte 0 ~ 7 to the counter channel 0 ~ 7 to clear counter data.

The object index 0x3100 can control the module to start or stop the pulse output of each channel. Each sub-index is corresponding to each channel. Users can use object index 0x2004 to decide the PWM method of each slot. If users select Burst Counting mode, the object index 0x3101 must be set to decide how many pulse users want to output. Users can set 1 ~ 65535 to the object 0x3101 and use object 0x3100 to start or stop the pulse output. Every time when set the object 0x3100 to 1, the channel will output the specific pulses with one burst cyclic. For example, user set channel 0 to Burst Counting mode and set object index 0x3101 with sub-index 1 to 100. When user set the object 0x3100 with sub-index 1 to 1, the channel 0 will output 100 pulses. Or if users select Continue Counting mode, the object 0x3101 will useless. When users set the object 0x3100 to 1, the channel will start to output the pulse cyclically until the object is set to 0. Or when user set the object 0x3100 to 0x81, the channel will start output with acceleration and set to 0x80 will stop with deceleration. If you want to change the frequency of pulse, you can set the value 2 ~ 5000000 with the base 0.1Hz (that is 0.2 Hz ~ 500 kHz) to object 0x3102.

Object index 0x3103 is pulse duty per mille (‰). If set the object to value 300, it means that the high duty is 300‰ and the low duty is 700‰ in one pulse width. The object 0x3104 can set the DI pin of the PWM module as hardware trigger channel. When set the value of object 0x3104 with sub-index 2 to 1, it

means the DI channel 2 will lose the DI functions and become a hardware trigger pin. In this case, if the value of DI channel 2 is changed, the channel 2 will start to output until the signal is clear.

Object 0x3105 and 0x3106 can control all of the channels of the PWM module to output synchronous. If user wish channel 0 ~ 3 of the PWM module output the pulse synchronously. Set the object 0x3105 with sub-index 1 ~ 4 to 1, and set the others to 0. Then, set the object 0x3106 with sub-index 1 to 1. These 4 channels (channel 0 ~ 3) will start to output pulse at the same time (their first low-to-high edge will be triggered at the same time, but the period may be different because of different pulse width). Take a note that the sub-index of the object 0x3106 only has one.

Object 0x3110 is deceleration object and 0x3111 is acceleration object. For example, if user set object 0x3111 to 100, object 0x3102 to 10000, and then set object 0x3100 to 0x81 (not set to 0x01). The channel will start output pulse from 0 Hz to 1000 Hz with acceleration of 10 Hz per million second. When user set object 0x3110 to 100 and set 0x3100 to 0x80 (not set to 0). The channel will start output pulse from 1000 Hz to 0 Hz with deceleration of 10 Hz per million second. If the value of object 0x3110 is 0, the command, 0x80, is equal to 0x00 for object 0x3100, and if the value of object 0x3111 is 0, the command, 0x81, is equal to 0x01 for object 0x3100.

Object 0x3112 can group the PWM channel. Per group has two channels, and only one of these two channels can output at the same time. The group setting is below, ch0-ch1, ch2-ch3, ch4-ch5, and ch6-ch7. So if set the object 0x3112 with sub-index 1 to 1, the object 0x3112 with sub-index 2 will be set to 1 automatically. Or If set the object 0x3112 with sub-index 2 to 1, the object 0x3112 with sub-index 1 will be set to 1 automatically, too.

3.4 Default PDO Mapping

RxPDO mapping list:

ID	Len	D 0	D 1	D 2	D 3	D 4	D 5	D 6	D 7
200h + x	8	PO 0	PO 1	PO 2	PO 3	PO 4	PO 5	PO 6	PO 7

Table 3-12 Default RxPDO list

Note: Clear counter function is not default mapping.

TxPDO mapping list:

ID	Len	D 0	D 1	D 2	D 3	D 4	D 5	D 6	D 7
180h + x	1	DI 0 ~ 7							
280h + x	8	DI Counter 0				DI Counter 1			
380h + x	8	DI Counter 2				DI Counter 3			
480h + x	8	DI Counter 4				DI Counter 5			

Table 3-13 Default TxPDO list

Note: DI Counter 6 and 7 are not default mapping.

Note: x is Node-ID of the module