

# **Industrial 2G/3G module**

## **I-8212W/I-8213W**

## **I-8212W-3GWA/I-8213W-3GWA**

### **User Manual**

#### **Warranty**

All products manufactured by ICP DAS are warranted against defective materials for a period of one year from the date of delivery to the original purchaser.

#### **Warning**

ICP DAS assumes no liability for damages consequent to the use of this product. ICP DAS reserves the right to change this manual at any time without notice. The information furnished by ICP DAS is believed to be accurate and reliable. However, no responsibility is assumed by ICP DAS for its use, or for any infringements of patents or other rights of third parties resulting from its use.

#### **Copyright**

Copyright 2011 by ICP DAS Co., Ltd. All rights reserved worldwide.

#### **Trademark**

The names used for identification only may be registered trademarks of their respective companies.

# Table of Contents

Chapter 1 Introduction .....	3
Chapter 2 Hardware Specifications .....	4
2.1.1 I-8212W/I-8213W .....	4
2.1.2 I-8212W/I-8213W Specifications .....	5
2.1.3 I-8212W/I-8213W Features .....	7
2.2.1 I-8212W-3GWA/I-8213W-3GWA .....	8
2.2.2 I-8212W-3GWA/I-8213W-3GWA Specifications .....	9
2.2.3 I-8212W-3GWA/I-8213W-3GWA Features .....	11
Chapter 3 Application architecture .....	12
Chapter 4 Hardware Appearance .....	13
4.1 Pin Assignments .....	13
4.2 Hardware Dimensions .....	15
4.3 LED indicators .....	17
Chapter 5 Hardware Installation .....	19
5.1 SIM card Installation .....	19
5.2 Antenna Installation .....	19
5.3 Install I-8212W/ I-8213W / I-8212-3GWA / I-8213-3GWA module .....	20
5.3.1 XP-8000 (Windows Embedded Standard 2009) .....	20
5.3.2 WinPAC-8000 (WinCE 5.0 Based) .....	27
5.3.3 iPAC-8000 (miniOS7 Based) .....	31
5.3.4 LinPAC-8000 (Linux kernel 2.6 based) .....	32
Chapter 6 GPRS connection .....	33
6.1 XP-8000 (Windows Embedded Standard 2009) .....	33
6.2 WinPAC-8000 (WinCE 5.0 Based) .....	48
6.3 LinPAC-8000 (Linux kernel 2.6 based) .....	59
Chapter 7 Quick test GPS (I-8213W /I-8213W-3GWA only) .....	62
7.1 XP-8000 (Windows Embedded Standard 2009) .....	62
7.2 WinPAC-8000 (WinCE 5.0 Based) .....	63
7.3 iPAC-8000 (miniOS7 Based) .....	64
7.4 LinPAC-8000 (Linux kernel 2.6 based) .....	65

## Chapter 1 Introduction

The I-8212W/I-8213W is an industrial Quad-band GSM/GPRS module with GPS function (only I-8213W) that work on frequencies of 850/900/1800/1900 MHz. The I-8212W-3GWA/I-8213WA is an industrial Tri-band 3G module with GPS function (only I-8213W-3GWA) that work on frequencies of WCDMA 2100/1900/850 MHz and GSM 850/900/1800/1900 MHz. These modules utilize the 2G/3G network for convenient and inexpensive data transfer from remote instruments, meters, computers or control systems in either live data or packet data. These modules have the integrated TCP/IP stack so that even simple controllers with serial communications ports can be connected to the modem without the need for special driver implementation. With the features of theirs, the systems can be SMS and GPRS or 3G connection applications with our PAC series like iPAC-8000, WinPAC-8000, LinPAC-8000 or XP-8000.

**PAC**

**WinPAC-8000**

**XP-8000**

**ViewPAC**

**iPAC-8000**

**LinPAC-8000**

**I-8212W**

**SMS Application**

**GPRS Application**

**NEW!!**

**【Industrial Quad-band 2G GSM/GPRS module】**

## Chapter 2 Hardware Specifications

### 2.1.1 I-8212W/I-8213W



## 2.1.2 I-8212W/I-8213W Specifications

Models	I-8212W	I-8213W
<b>GSM/GPRS System</b>		
GPRS/GSM Quad-band	850/900/1800/1900 MHz	
GPRS Multi-slot	Class 10/8	
GPRS Mobile Station	Class B	
GPRS Class 10	Max. download speed 85.6 kbps; Uplink transfer: Max 42.8 kbps	
CSD	Up to 14.4 kbps	
Compliant to GSM Phase 2/2+	MT, MO, CB, Text and PDU mode	
Coding Schemes	CS 1, CS 2, CS 3, CS 4	
SMS	Text and PDU Mode	
<b>GPS System</b>		
Support Channels	-	32
Sensitivity	-	Tracking = up to -159 dBm (with external LNA) Cold start = up to -146 dBm (with external LNA)
Acquisition Time	-	Hot start (Open Sky) = 2 sec.(typical) Cold start (Open Sky) = 36 sec.(typical)
Protocol Support	-	NMEA 0183 version 3.01
<b>LED Indicators</b>		
Power	Red color	
GSM/GPRS	Yellow color	
GPS	-	Green color
<b>Power</b>		
Frame Ground Protection	ESD, Surge, EFT, Hi-Pot	
Power Consumption	Idle: 0.16 A @ 5 V <sub>DC</sub> ; Data Link: 0.2 ~ 1.64 A (peak) @ 5 V <sub>DC</sub>	
<b>Mechanical</b>		
Casing	Plastic	
Dimensions	30 mm x 85 mm x 114 mm	

(W x L x H)	
Environment	
Operating Temperature	-25 °C ~ +75 °C
Storage Temperature	-30 °C ~ +80 °C
Humidity	5 ~ 95% RH, non-condensing

**Note1: The default setting of GSM/GPRS module is as following on I-8212W/I-8213W.**

Parameters	Default value
Baud rate	115200 bps
Parity	None
Date bit	8
Stop bit	1

**Note2: The default setting of GPS module is as following on I-8213W.**

Parameters	Default value
Baud rate	9600 bps
Parity	None
Date bit	8
Stop bit	1

### 2.1.3 I-8212W/I-8213W Features

- Quad-band GSM/GPRS Modem Operating on 850/900/1800/1900 MHz
- 4 KV ESD Protection
- Designed for GPRS and SMS Applications
- Support TCP Server, TCP Client, UDP Client Connection stack from GPRS
- Support Standard AT Commands
- LED Indicators for Power, GSM and GPS(only I-8213W) Indication
- High Reliability in Harsh Environment
- Support 32-channels GPS and NMEA v0183 v3.01(only I-8213W)
- PPS: 100 ms pulse output/sec for precise timekeeping and time measurement(only I-8213W)
- Support XP-8000, WinPAC-8000, LinPAC-8000, ViewPAC, iPAC-8000

## 2.2.1 I-8212W-3GWA/I-8213W-3GWA





## 2.2.2 I-8212W-3GWA/I-8213W-3GWA Specifications

Models	I-8212W-3GWA	I-8213W-3GWA
<b>3G System</b>		
Frequency Band	UMTS : 2100/1900/850 MHz	
Data Transmission	UMTS / HSDPA / HSUPA Downlink transfer: Max. 7.2Mbps; Uplink transfer: Max 5.76Mbps	
<b>GSM/GPRS System</b>		
Frequency Band	850/900/1800/1900 MHz	
GPRS connectivity	GPRS class 12/10; GPRS station class B	
DATA GPRS	Downlink transfer: Max. 85.6 kbps; Uplink transfer: Max 42.8kbps	
CSD	Max. download speed 85.6 kbps; Uplink transfer: Max 42.8 kbps	
Coding Schemes	CS 1, CS 2, CS 3, CS 4	
<b>SMS System</b>		
SMS	MT, MO, CB, Text and PDU mode	
<b>GPS System</b>		
Support Channels	-	32
Sensitivity	-	Tracking = up to -159 dBm (with external LNA) Cold start = up to -146 dBm (with external LNA)
Acquisition Time	-	Hot start (Open Sky) = 2 sec.(typical) Cold start (Open Sky) = 36 sec.(typical)
Protocol Support	-	NMEA 0183 version 3.01
<b>LED Indicators</b>		
Power	Red color	
GSM/GPRS	Yellow color	
GPS	-	Green color
<b>Power</b>		
Frame Ground Protection	ESD, Surge, EFT, Hi-Pot	
Power Consumption	Idle: 0.16 A @ 5 V <sub>DC</sub> ; Data Link: 0.2 ~ 1.64 A (peak) @ 5 V <sub>DC</sub>	
<b>Mechanical</b>		
Casing	Plastic	
Dimensions	30 mm x 85 mm x 114 mm	

(W x L x H)	
Environment	
Operating Temperature	-25 °C ~ +75 °C
Storage Temperature	-30 °C ~ +80 °C
Humidity	5 ~ 95% RH, non-condensing

**Note1: The default setting of the module is as following on I-8212W-3GWA/I-8213W-3GWA.**

Parameters	Default value
Baud rate	115200 bps
Parity	None
Date bit	8
Stop bit	1

**Note2: The default setting of GPS module is as following on I-8213W-3GWA.**

Parameters	Default value
Baud rate	9600 bps
Parity	None
Date bit	8
Stop bit	1

## 2.2.3 I-8212W-3GWA/I-8213W-3GWA Features

- Supports Tri-band UMTS 2100/1900/850 MHz and Quad-band GSM 850/900/1800/1900 MHz
- 4 KV ESD Protection
- Designed for WCDMA, GPRS and SMS Applications
- Supports TCP Server, TCP Client, UDP Client Connection stack from 3G or GPRS
- Support Standard AT Commands
- LED Indicators for Power, GSM and GPS(only I-8213W-3GWA) Indication
- High Reliability in Harsh Environment
- Support 32-channels GPS and NMEA v0183 v3.01(only I-8213W-3GWA)
- PPS: 100 ms pulse output/sec for precise timekeeping and time measurement(only I-8213W-3GWA)
- Support XP-8000, WinPAC-8000, LinPAC-8000, ViewPAC, iPAC-8000

## Chapter 3 Application architecture

➤ Application 1

### **Industrial Quad-band GSM/GPRS Module**

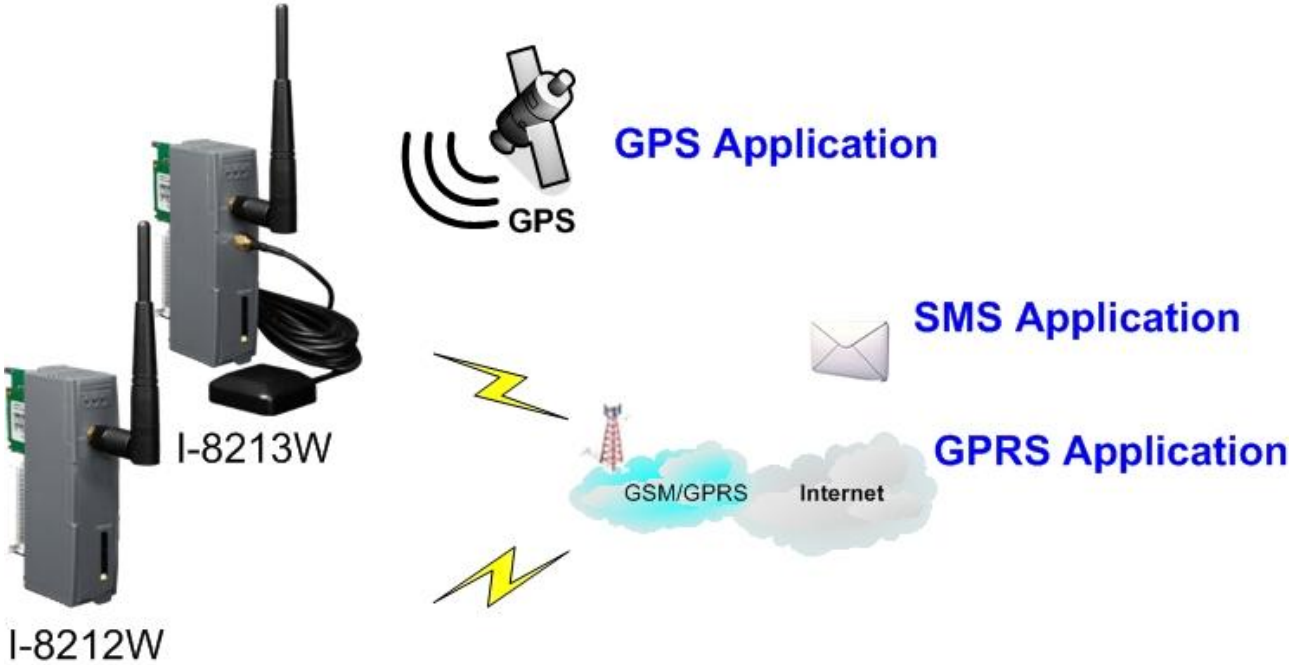

➤ Application 2

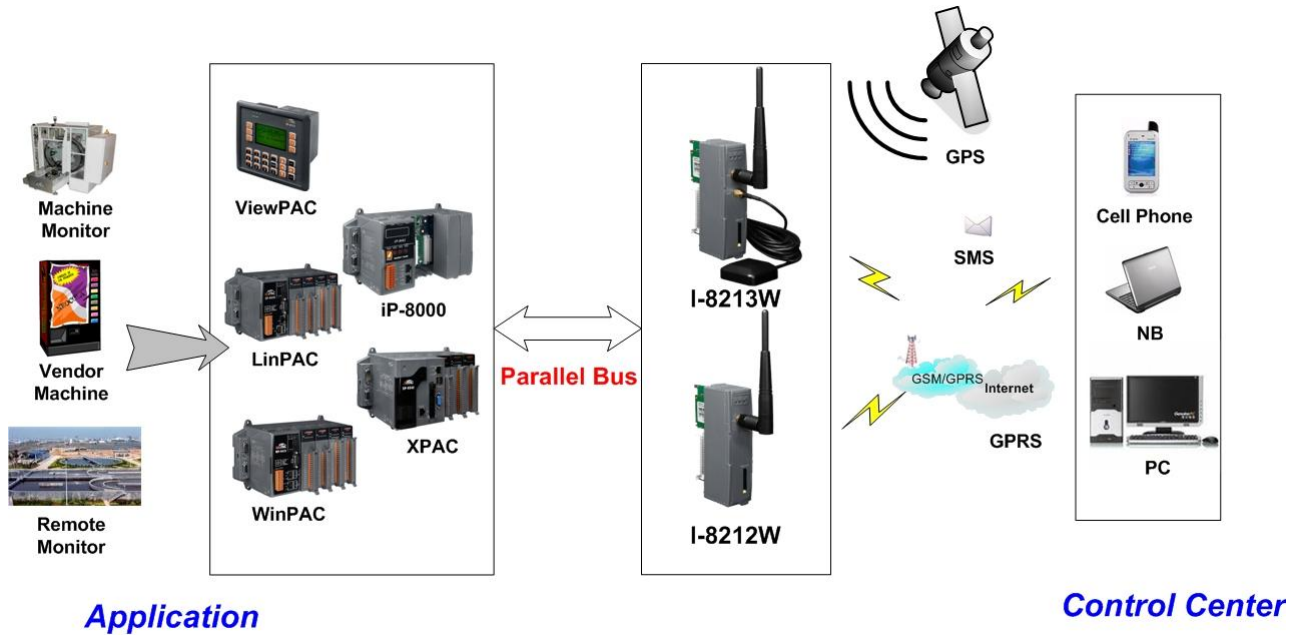

## Chapter 4 Hardware Appearance

### 4.1 Pin Assignments

#### ➤ I-8212W

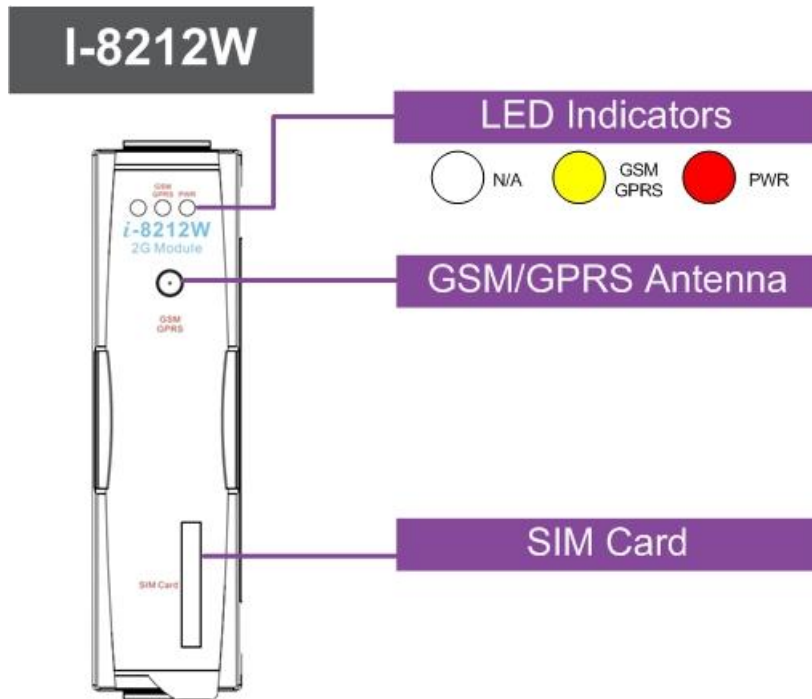

#### ➤ I-8213W

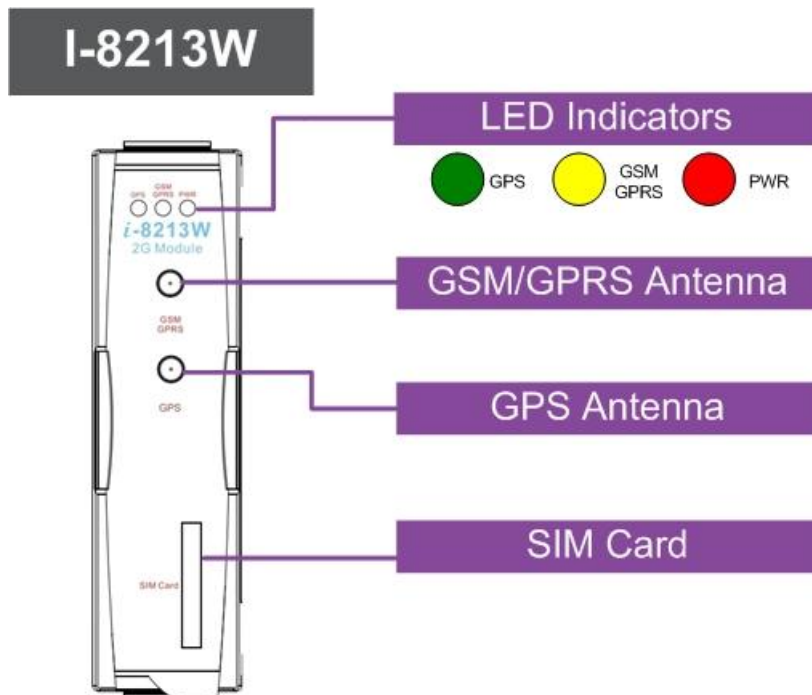

➤ I-8213W-3GWA

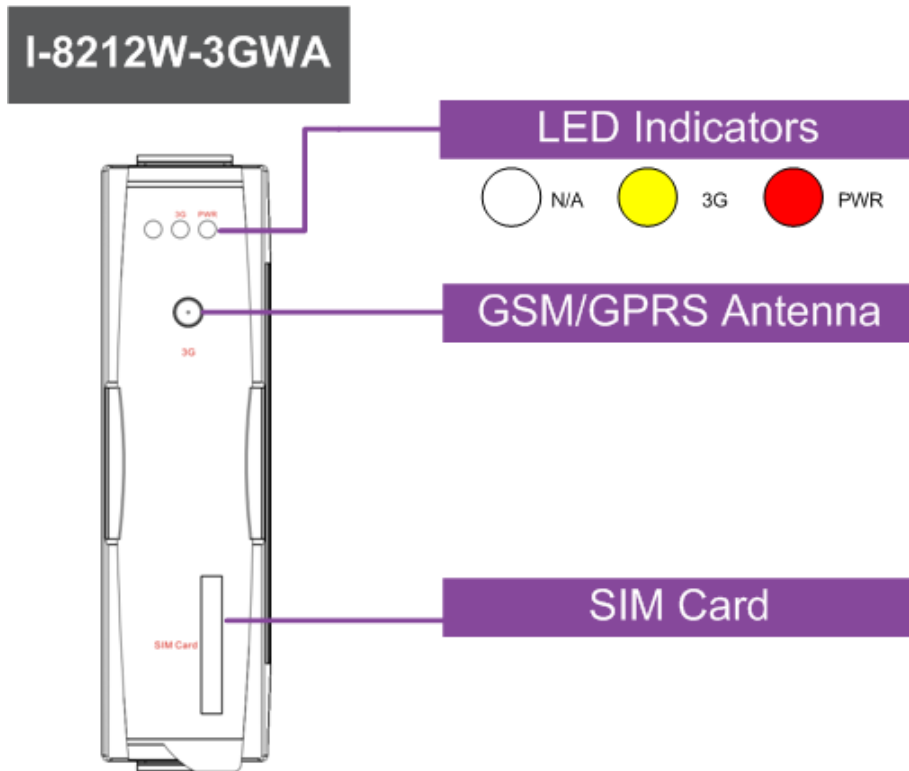

➤ I-8213W-3GWA

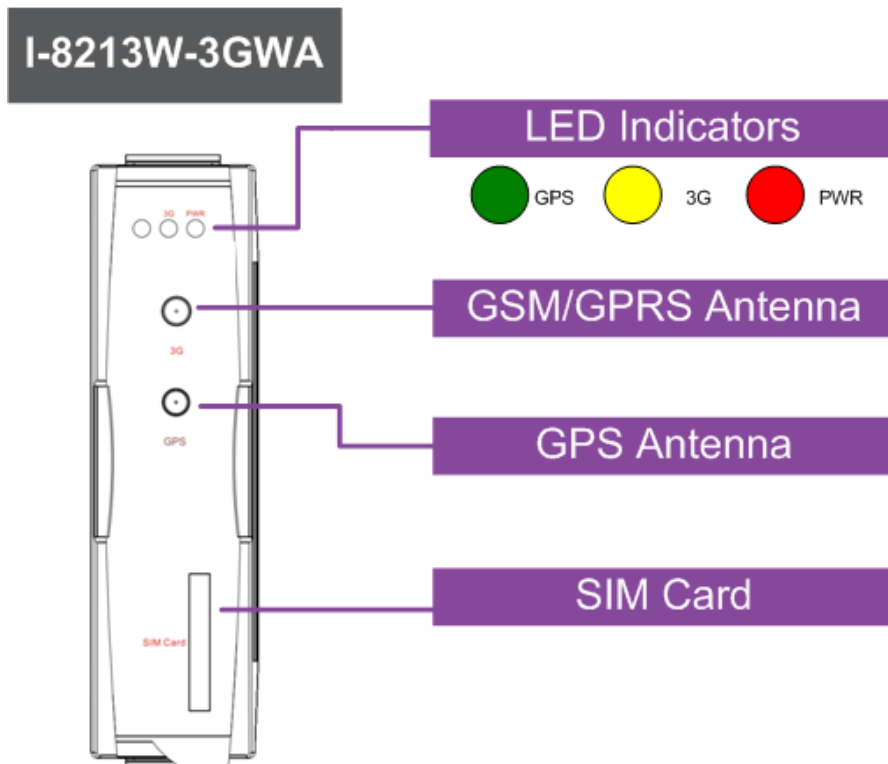

## 4.2 Hardware Dimensions

➤ I-8212W / I-8212W-3GWA

Unit: mm

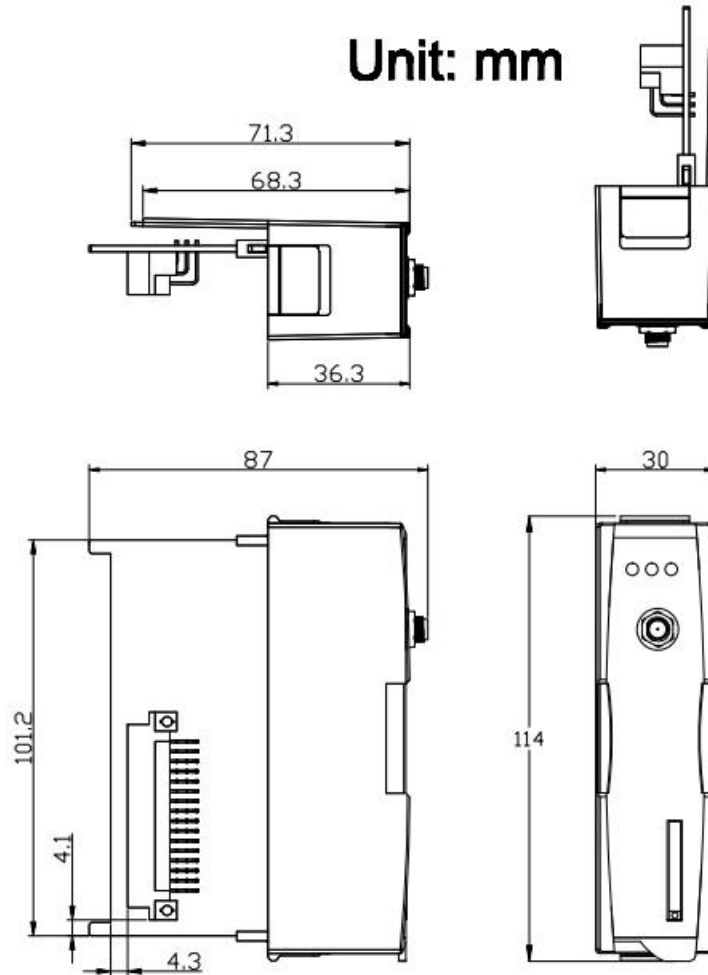

➤ I-8213W / I-8213W-3GWA

Unit: mm

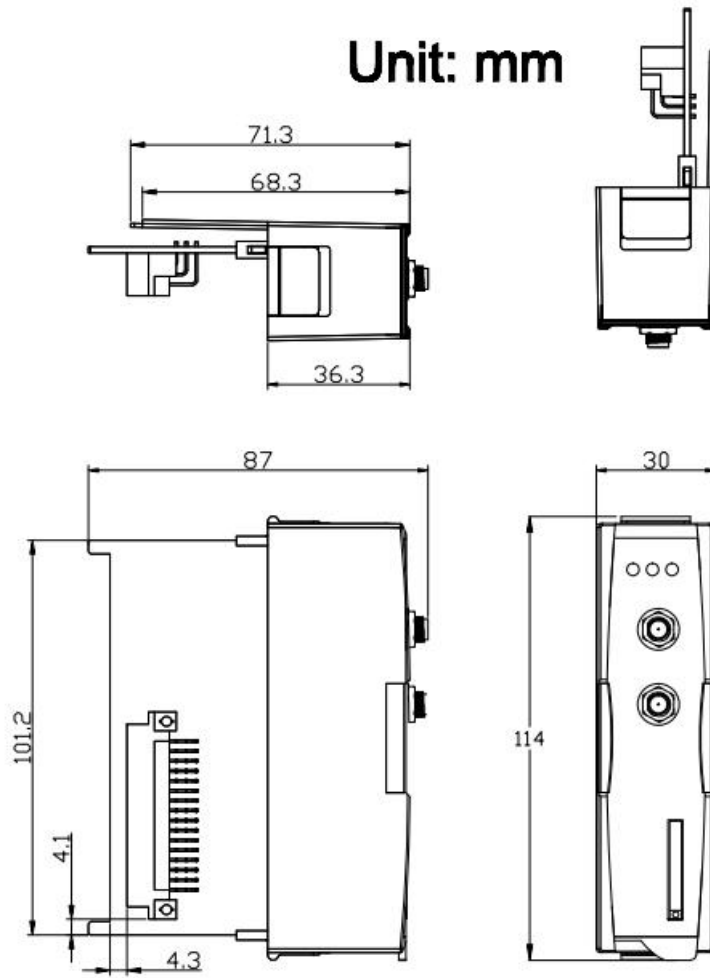



## 4.3 LED indicators



There are three LED indicators to help users to judge the various conditions. The description is as following :

- PWR(Red) : The PWR LED can indicate the status of Power module.

Power normal	Power fail
Always on	Always off

- GSM/GPRS (Yellow) : The modem LED can indicate the status of GSM module for I-8212W/I-8213W.

Modem normal	Modem fail
Blanking (3 sec)	Off or Blanking (not 3 sec)

- 3G (Yellow) : The modem LED can indicate the status of GSM module for I-8212W-3GWA/I-8213W-3GWA.

Modem normal	Modem fail
Blanking (0.8 sec)	OFF or ON

- GPS (Green) : The GPS LED can indicate the status of GPS module.(I-8213W / I-8213W-3GWA only)

GPS Fail	Search GPS	Receive GPS data
Always off	Always on	Blanking (1 sec)

## Chapter 5 Hardware Installation

### 5.1 SIM card Installation



### 5.2 Antenna Installation

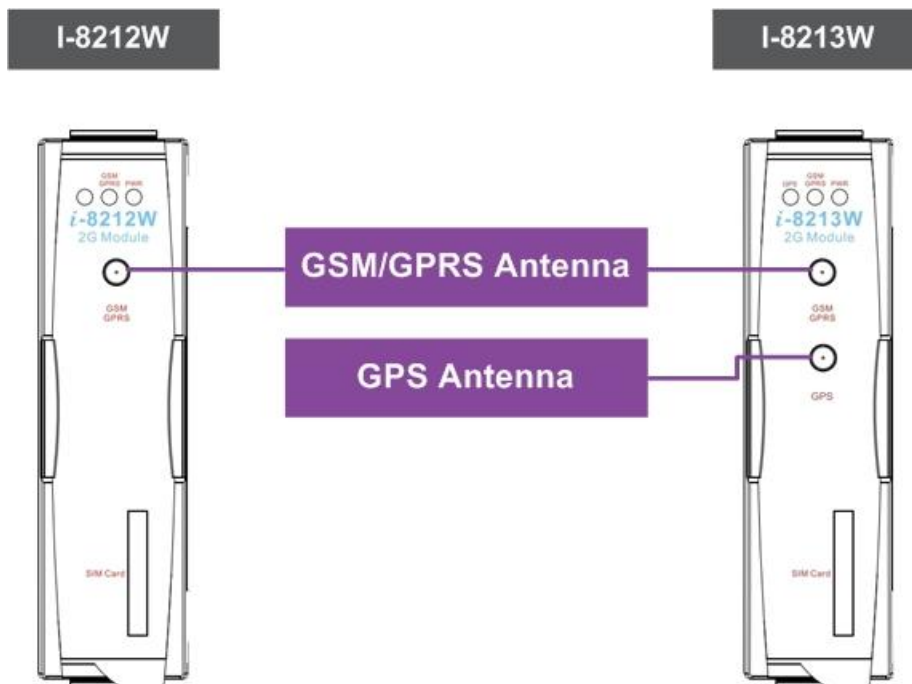

## 5.3 Install I-8212W/ I-8213W / I-8212-3GWA / I-8213-3GWA module

### 5.3.1 XP-8000 (Windows Embedded Standard 2009)

➤ Install module.

1. Install the module on the XP-8000.
2. Rotate the Rotary Switch as “2”. To disable EWF (ENHANCED WRITE FILTER).



3. Reboot your XP-8000

4. After reboot, execute the “Multi-Port IO module Register Wizard”.

4.1 Open Multi-Port IO Module Register Wizard,

Start => ICPDAS => Multi-Port IO Module Register Wizard

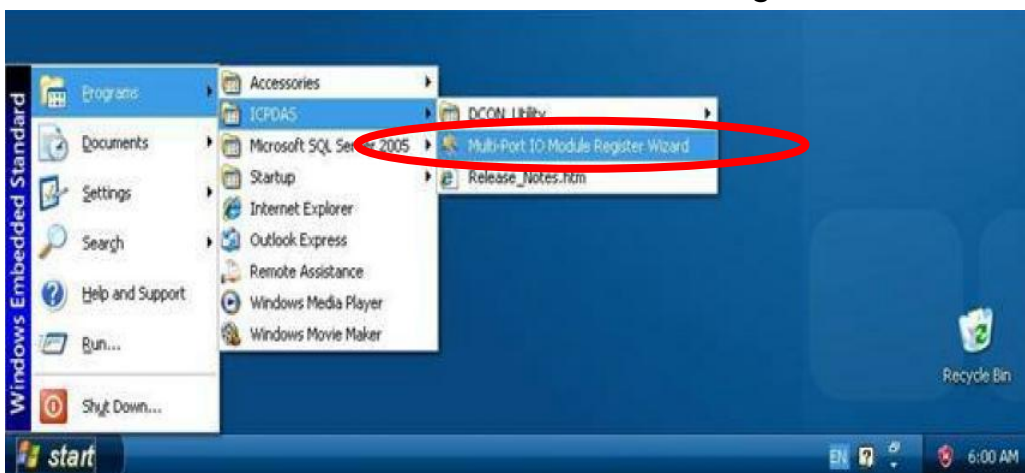

## 4.2 Register the module and select “Exit”

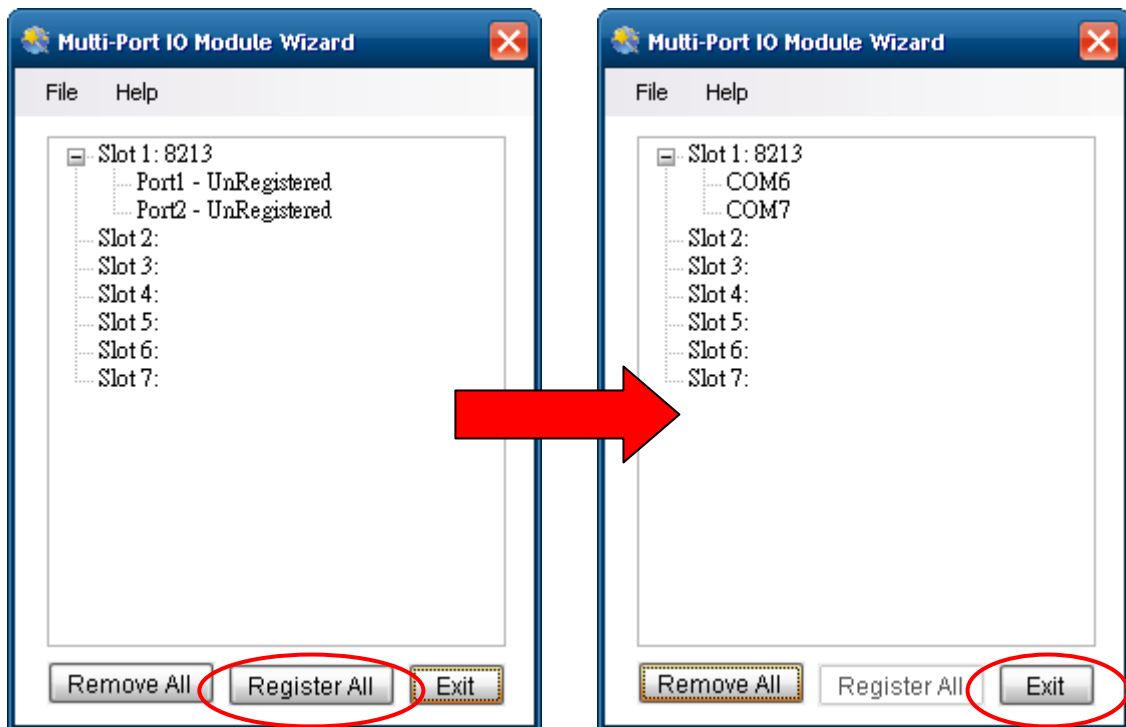

## 4.3 Select “OK” and reboot.



4.4 After reboot, XP-8000 will install ports of the module.

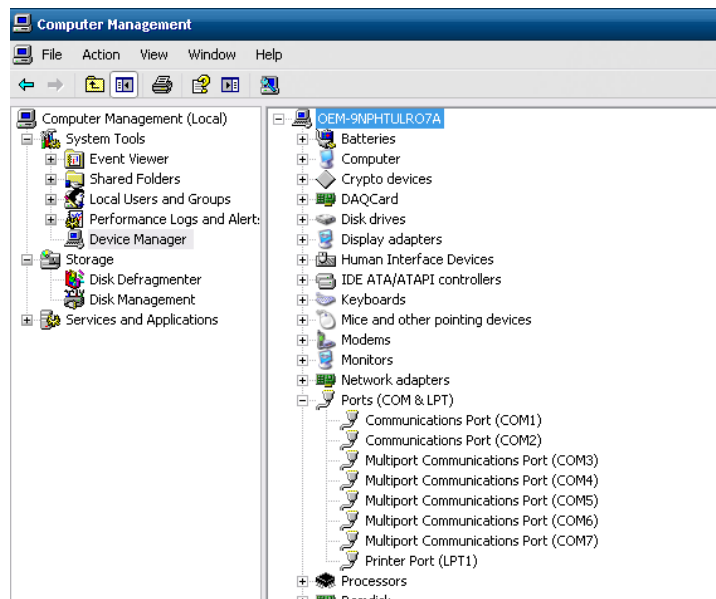

5 After finishing, rotate the Rotary Switch as "0" to enable EWF.



➤ Uninstall module

1. Rotate the Rotary Switch as “2” to disable EWF.



2. Reboot your XP-8000
3. After reboot, ensure the module is installed on XP-8000 and execute the “Multi-Port IO module Register Wizard”.
  - 3.1 Open Multi-Port IO Module Register Wizard,  
Start => ICPDAS => Multi-Port IO Module Register Wizard

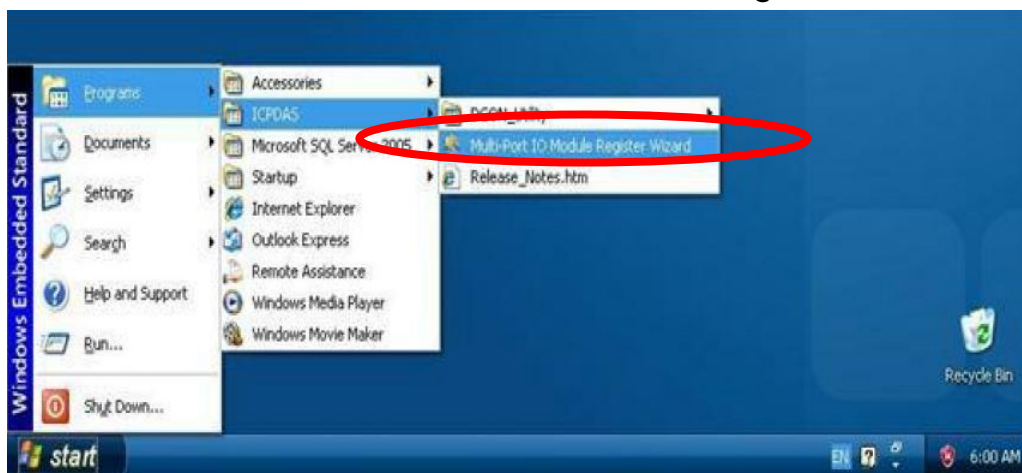

### 3.2 Remove module and select “Exit”

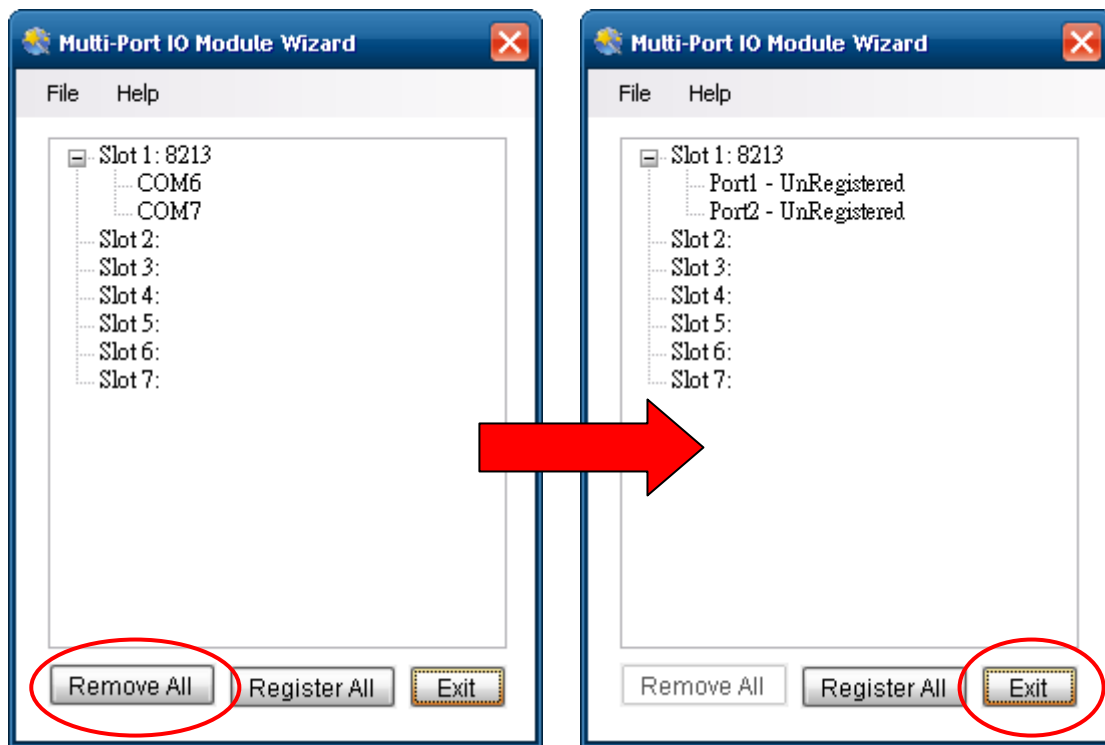

### 3.3 Select “OK” and reboot.





### 3.4 After reboot, XP-8000 will remove ports of the module.

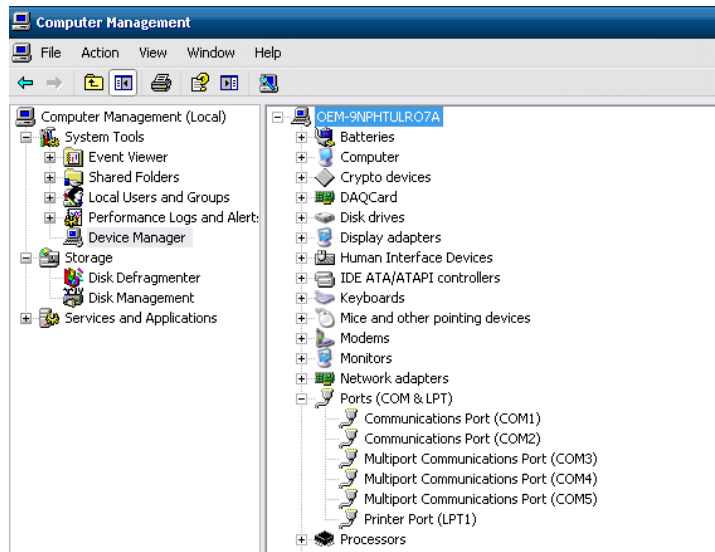

### 4 After finishing, rotate the Rotary Switch as "0". To enable EWF.



- The slot corresponds to com port number of I-8212W or I-8212W-3GWA

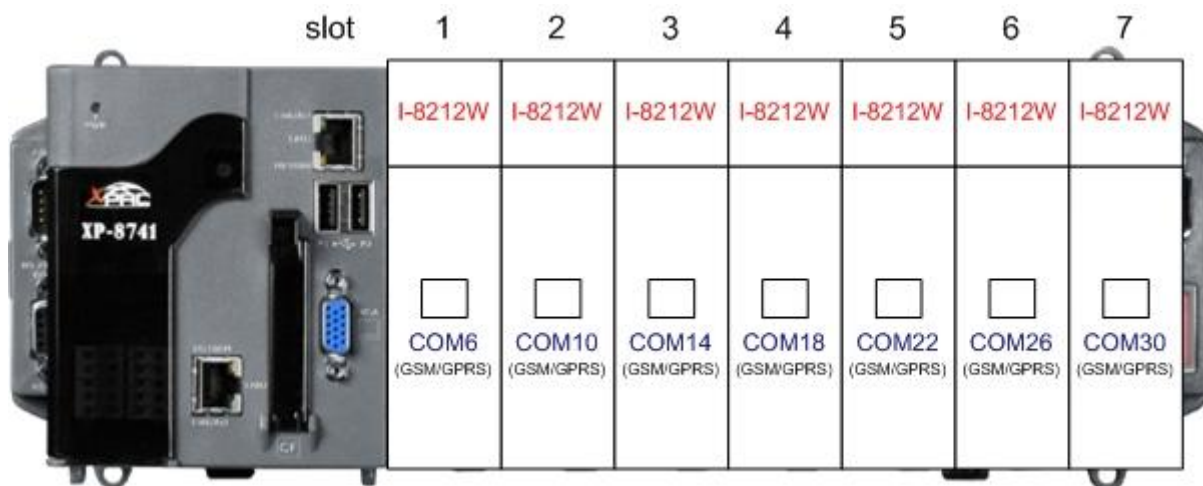

- The slot corresponds to com port number of I-8213W or I-8213W-3GWA

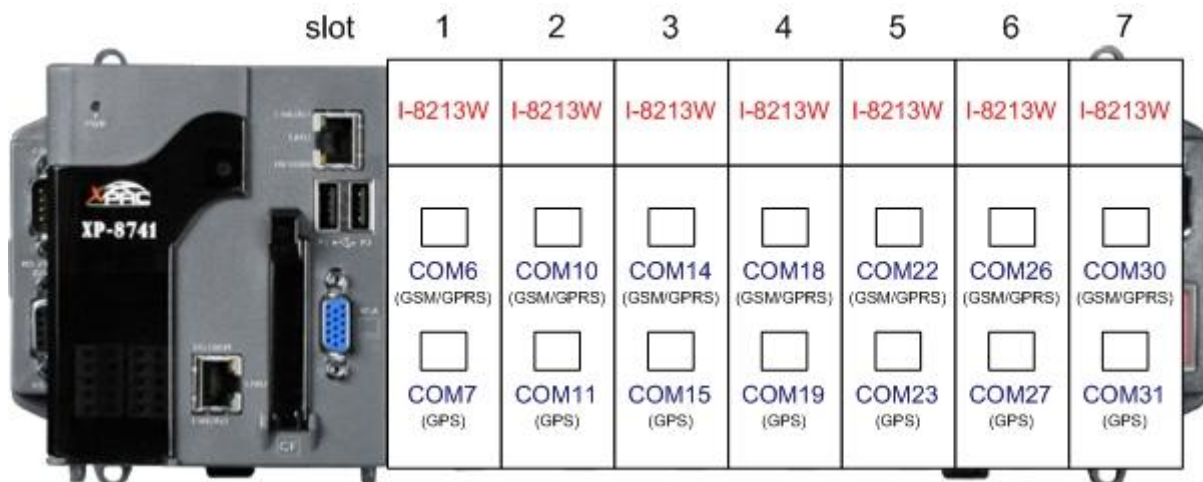

## 5.3.2 WinPAC-8000 (WinCE 5.0 Based)

### ➤ Install the module

1. Install the module on the WinPAC-8000

2. Reboot your WinPAC-8000

3. After reboot, execute the “WinPAC Utility”.

3.1 Select the “USE COMx” and then click the “Set” button.

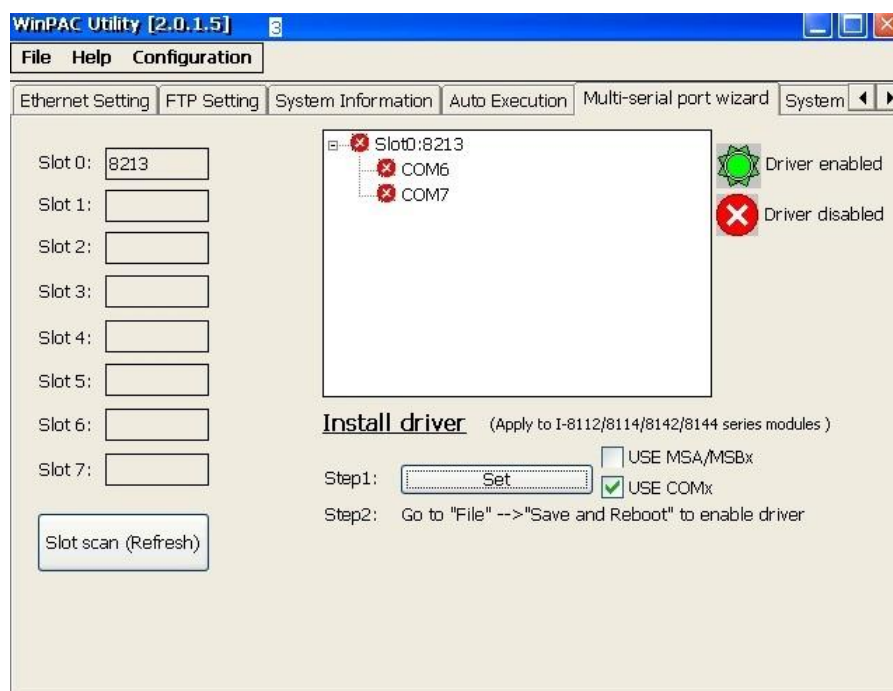
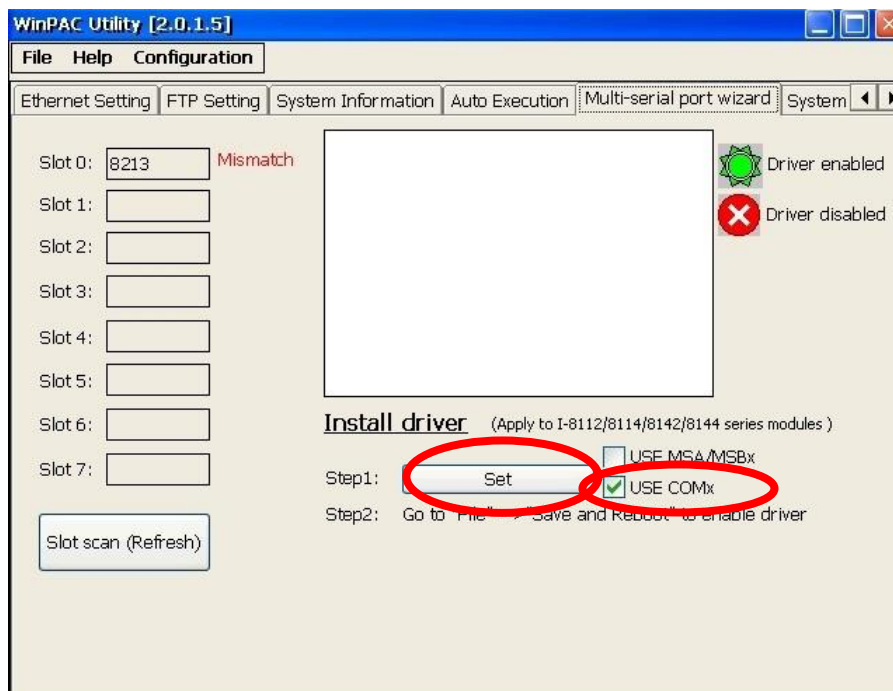

### 3.2 Save and Reboot parameters

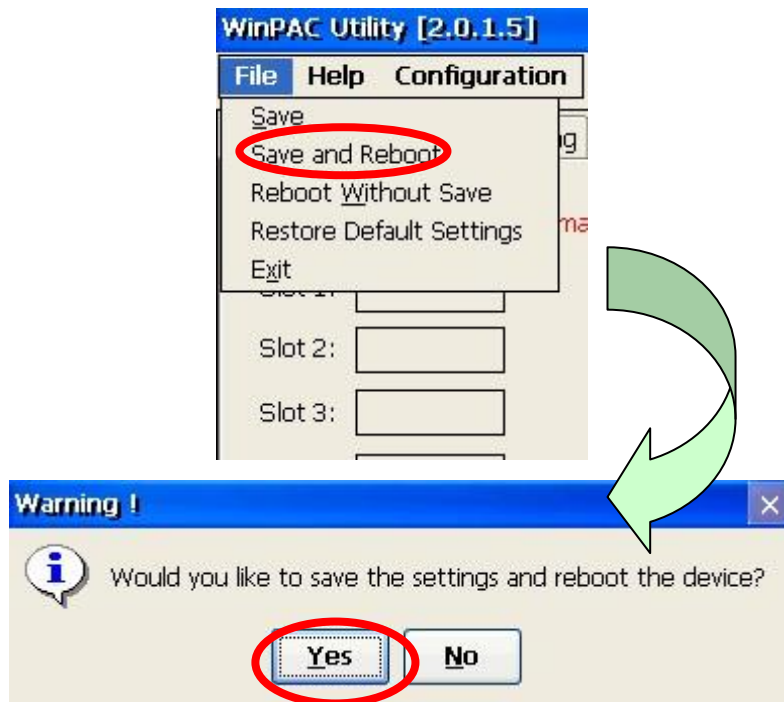

4. After reboot, execute the "WinPAC Utility" to check.

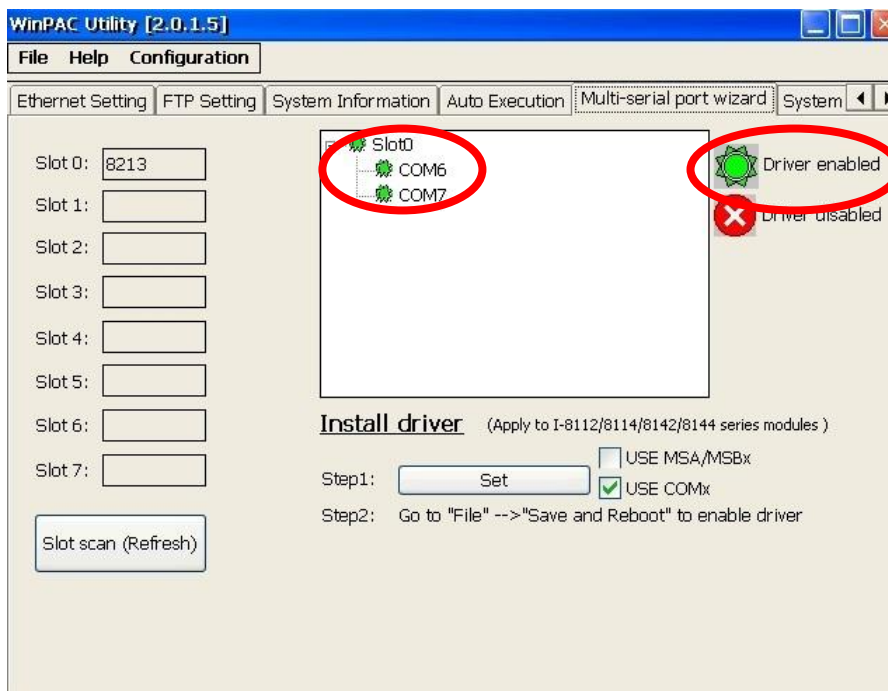

➤ Uninstall the module

1. Remove the module on the WinPAC-8000
2. Reboot your WinPAC-8000
3. After reboot, execute the "WinPAC Utility".
  - 3.1 Click the "Set" button to remove driver.

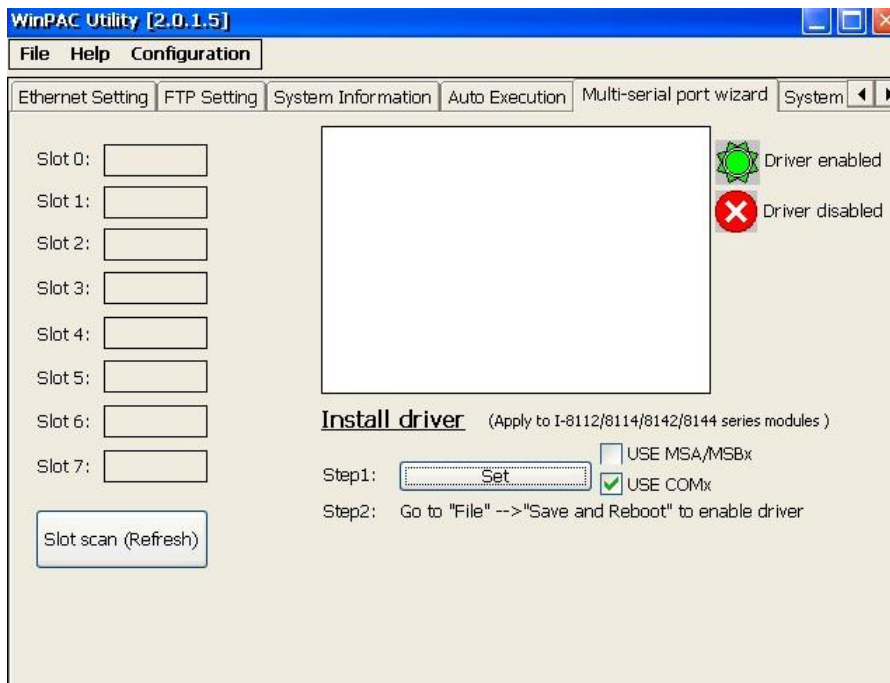
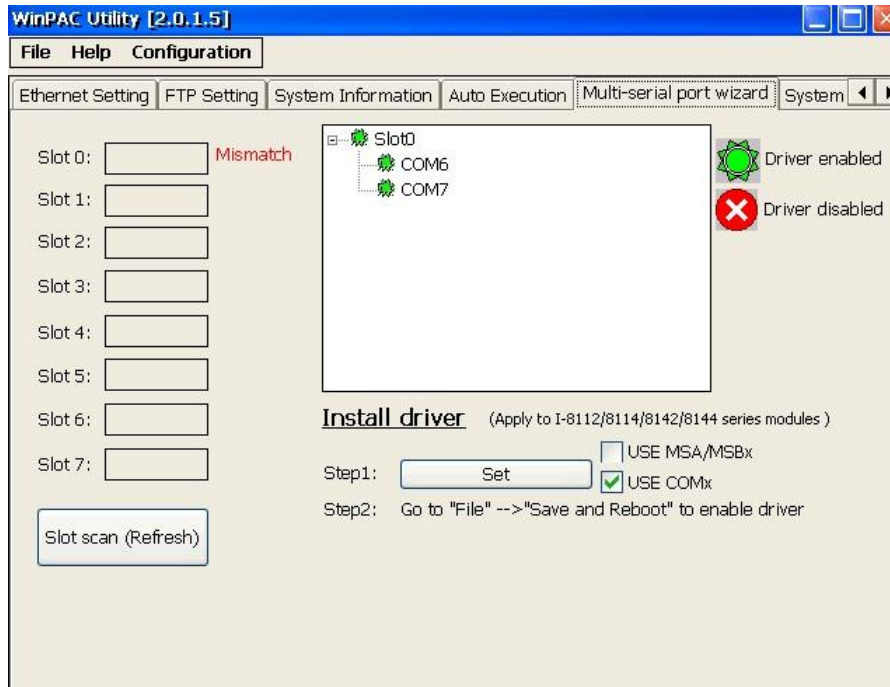

### 3.2 Save and Reboot parameters

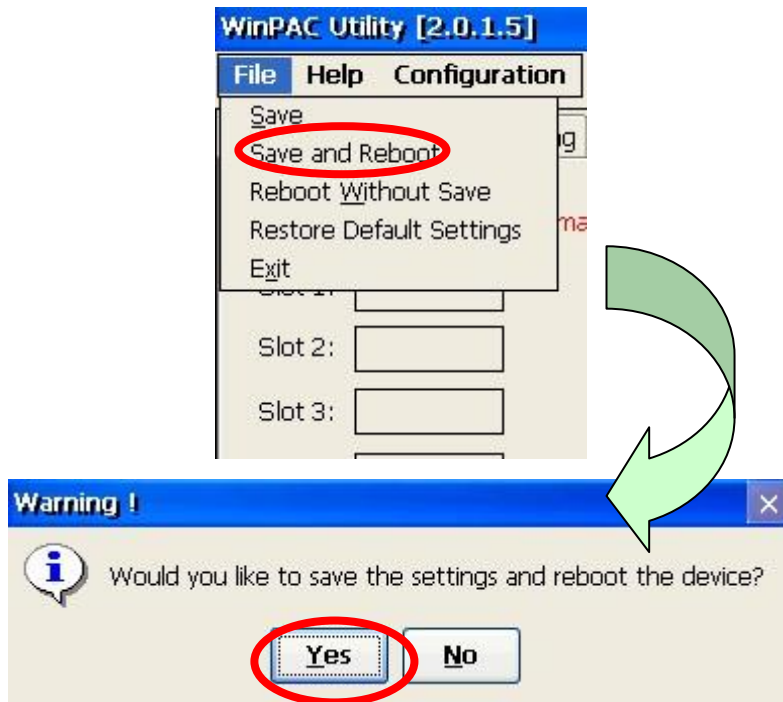

### 5.3.3 iPAC-8000 (miniOS7 Based)

1. Turn on the power of your iPAC-8000 after install the module on your iPAC-8000.
2. The slot corresponds to com port number below.

#### ➤ I-8212W / I-8212W-3GWA

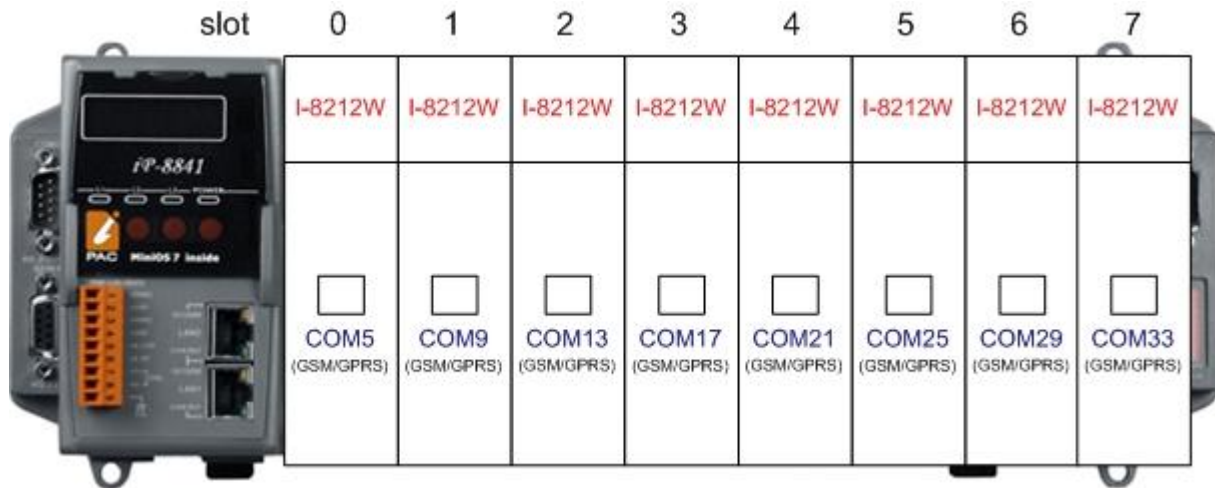

#### ➤ I-8213W / I-8213-3GWA

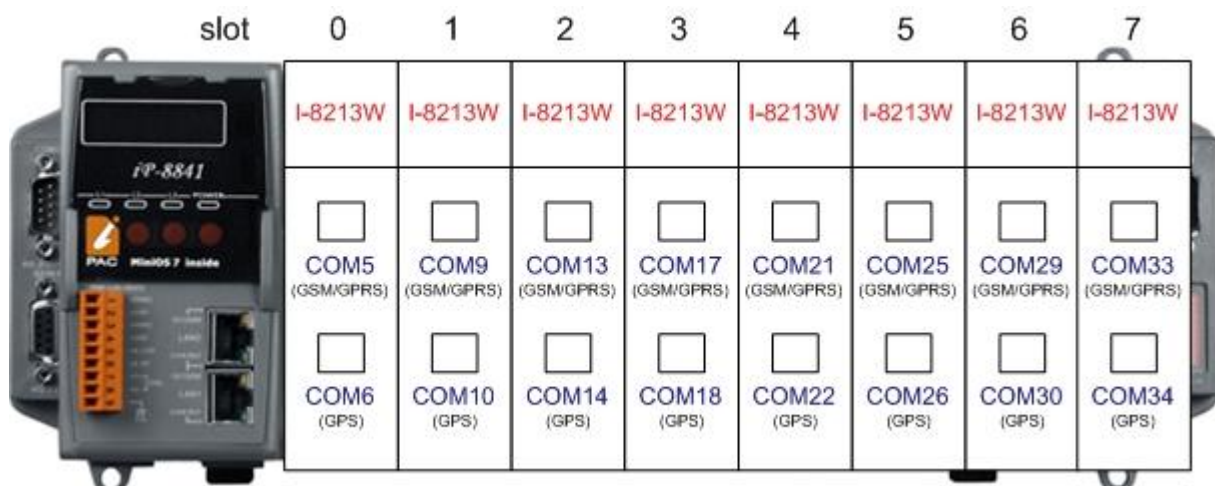

### 5.3.4 LinPAC-8000 (Linux kernel 2.6 based)

1. Turn on the power of your LinPAC-8000 after install the module on your LinPAC-8000.
2. The slot corresponds to com port number below.

#### ➤ I-8212W / I-8212W-3GWA

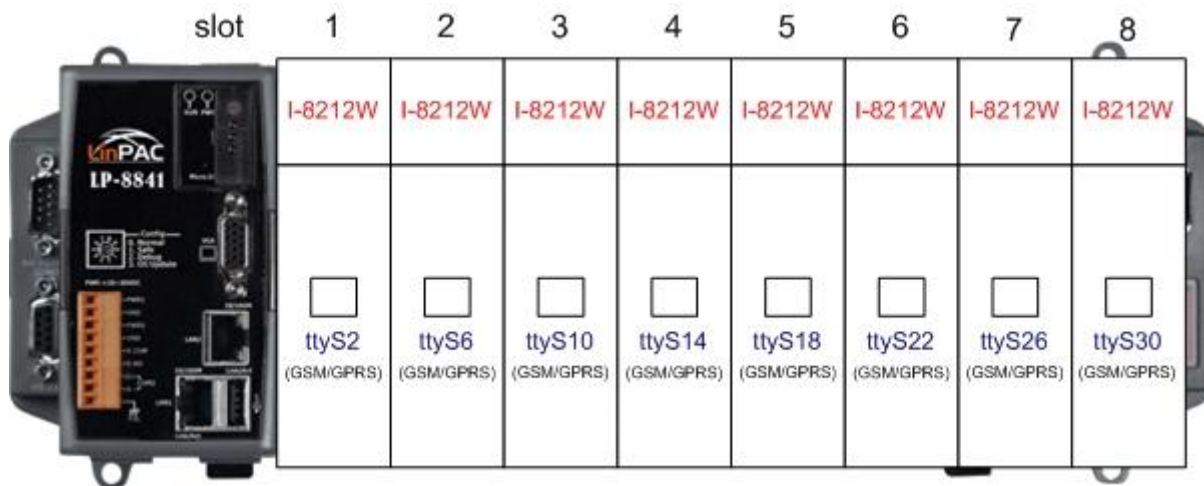

#### ➤ I-8213W / I-8213W-3GWA

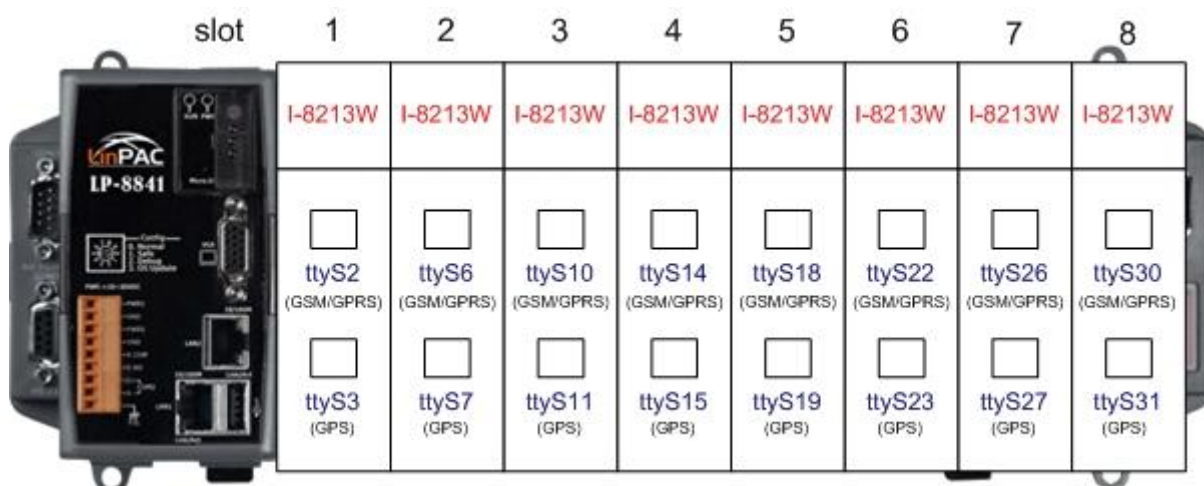



## Chapter 6 GPRS connection

### 6.1 XP-8000 (Windows Embedded Standard 2009)

➤ Hardware requirement

- 1) I-8212W/I-8213W/I-8212W-3GWA/I-8213W-3GWA
- 2) XP-8000



XPAC-8000



I-8212W/I-8213W

➤ Create a new modem connection

Step1. Control Panel → Double-click “Phone and Modem Options”

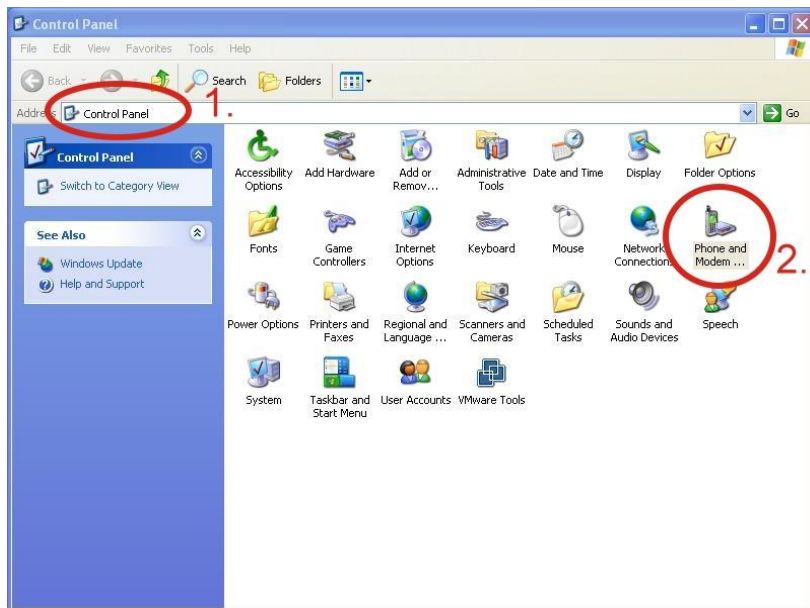

Step2. Set the area code for the first time → Click “OK”

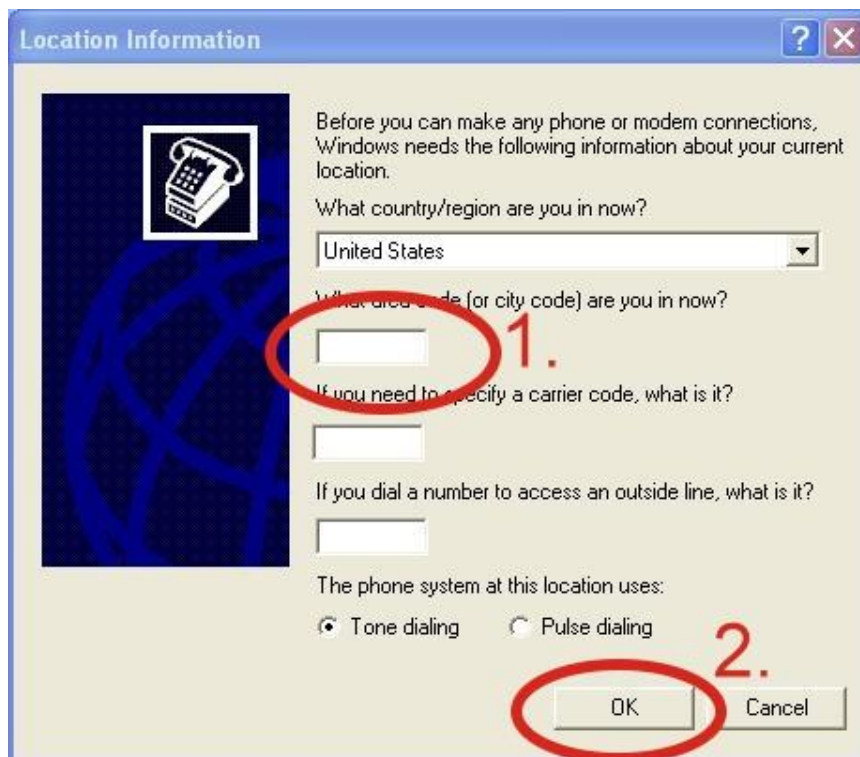

Step3. Control Panel → Double-click “Phone and Modem Options” → Modem → Click “Add”

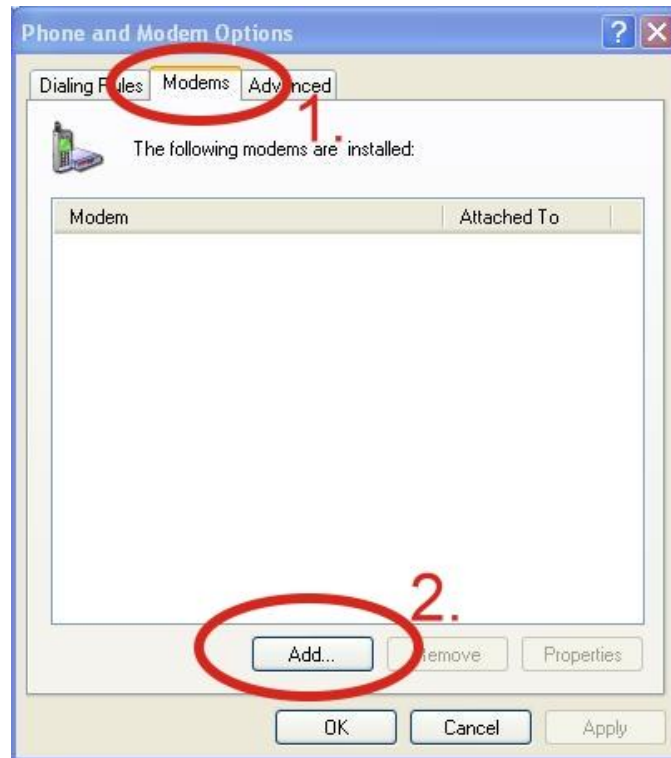

Step4. Select “Don’t detect my modem; I will select it from a list.” → Click “Next”



- Step5. Select "Standard Modem Types" → Select "Standard 19200 bps Modem"  
→ Click "Next"

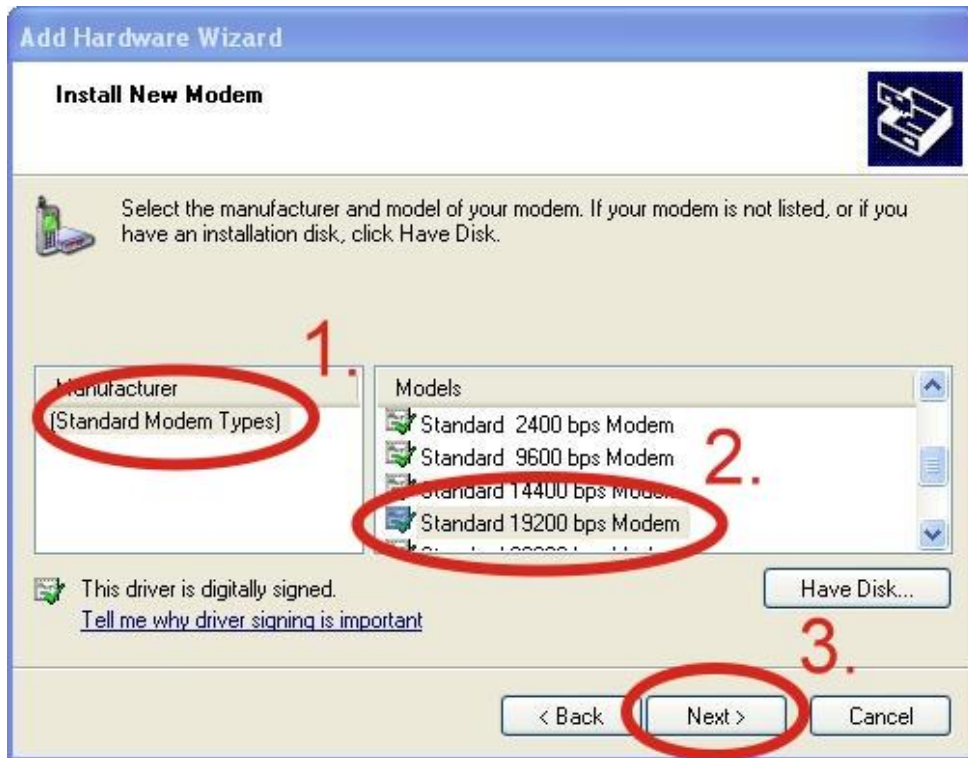

- Step6. Select your COM Port to connect to the modem → Click "Next"

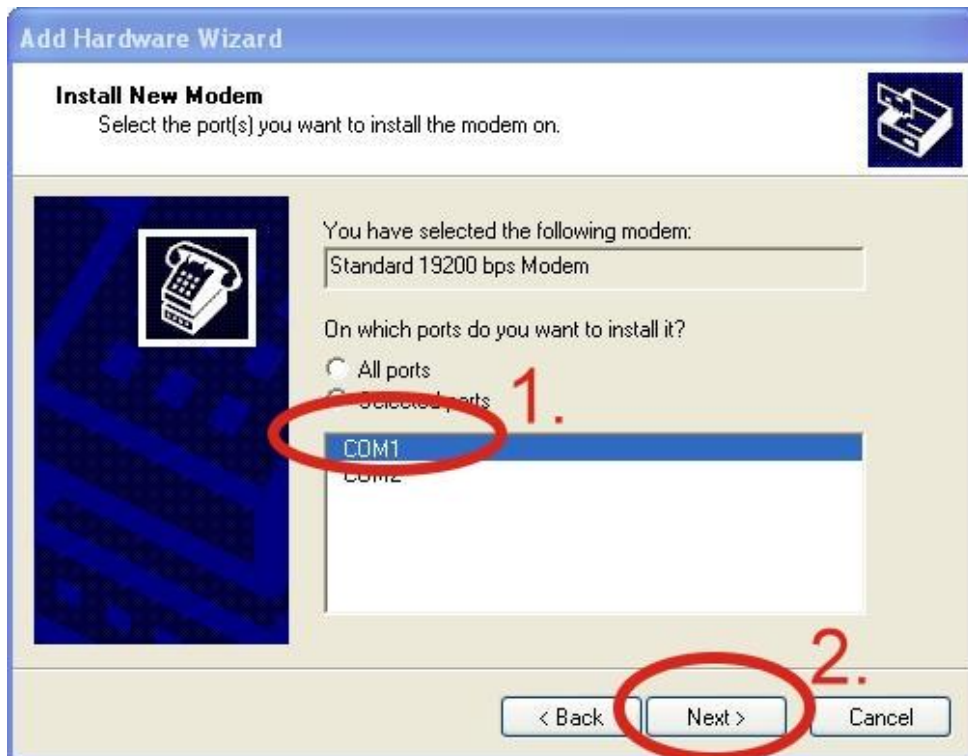

Step7. Click “Finish” to finish the install new modem.



Step8. Control Panel → Double-click “Phone and Modem Options” → Modem → Select “Standard 19200 bps Modem” → Click “Properties”

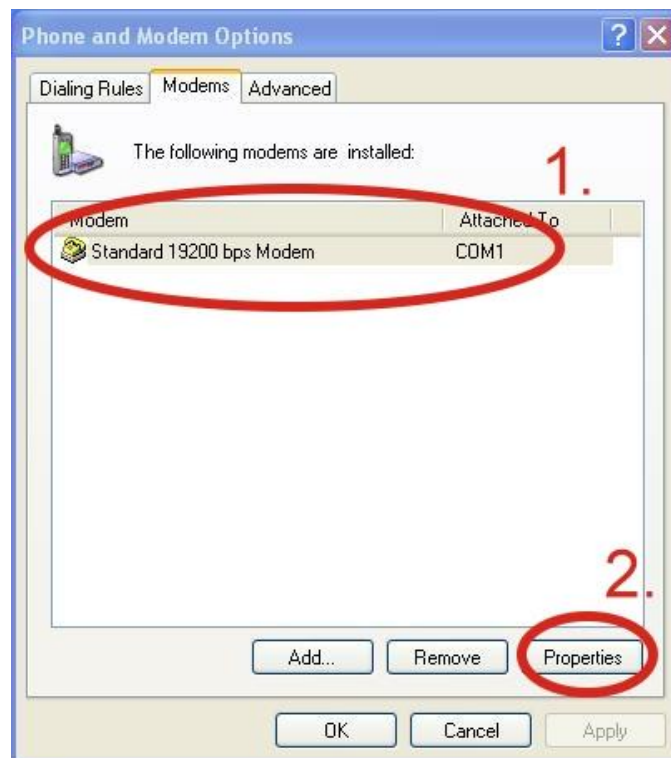

Step9. Control Panel → Double-click “Phone and Modem Options” → Modem →  
Select “Standard 19200 bps Modem” → Click “Properties” → Modem →  
Maximum Port Speed → 115200

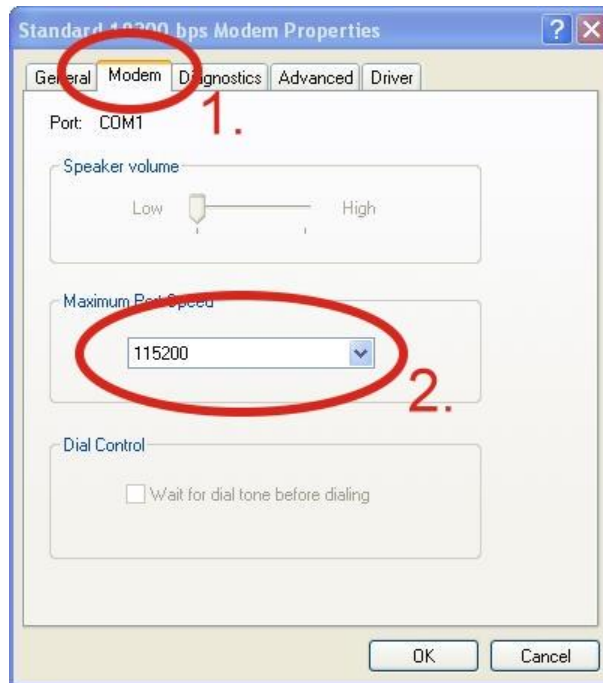

Step10. Advanced → Extra initialization commands:

**Note:** GPRS's APN must be provided from your Telecom. CO., LTD.

For example in Taiwan: AT+CGDCONT=1,"IP","INTERNET"

For example in China: AT+CGDCONT=1,"IP","CMNET"



Step11. Diagnostics → Query Modem →Click “OK”

Note: If user queries the modem and gets an error message, Please try again.

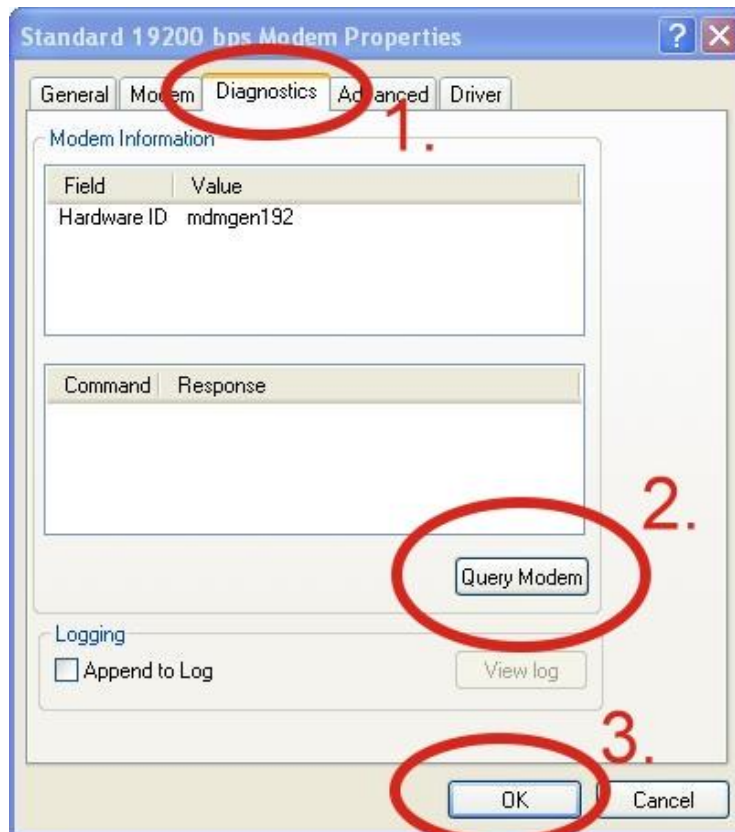

Step12. Click “OK”

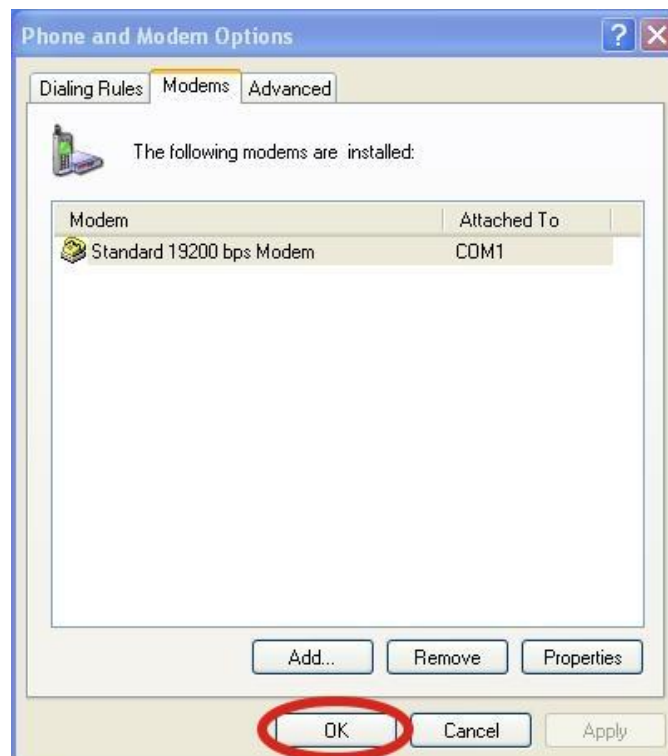

➤ Create a new dial-up and networking connection

Step1. Control Panel → Network Connections → Click “Create a new connection”

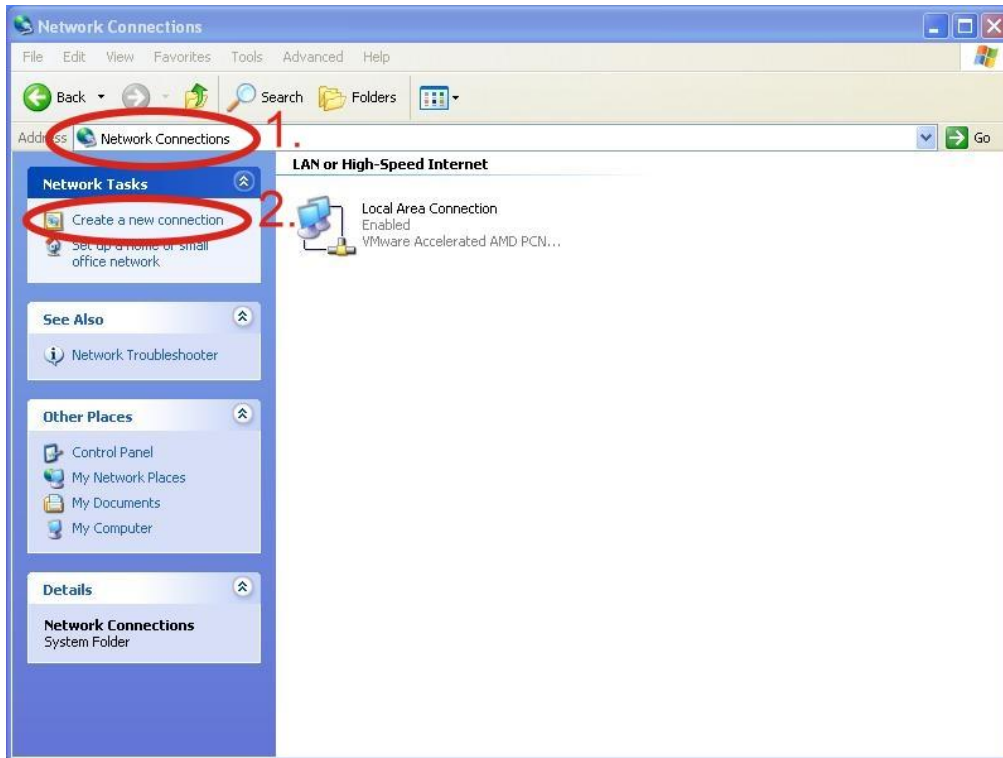

Step2. Click “Next”





Step3. Select "Connect to the Internet" → Click "Next"

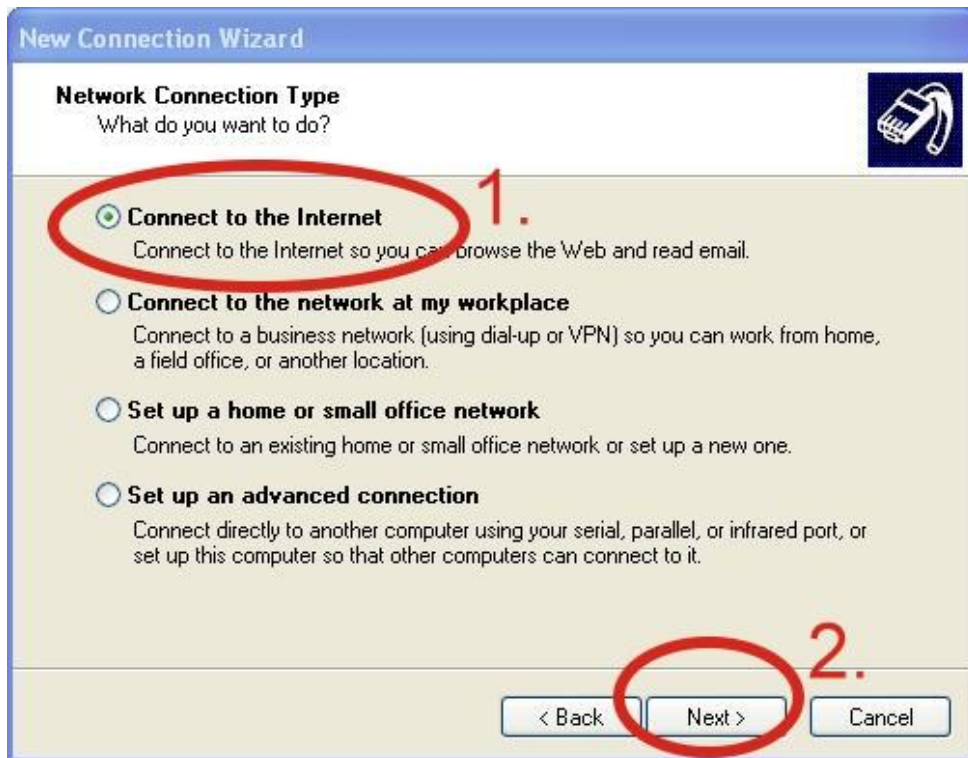

Step4. Select "Connect using a dial-up modem" → Click "Next"

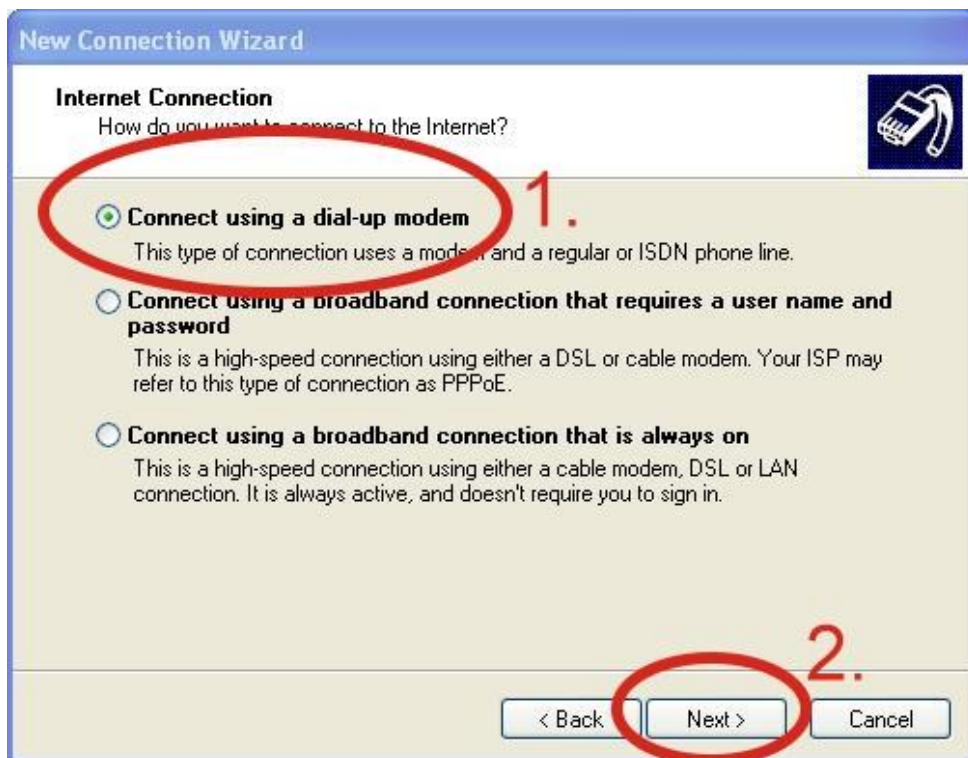

Step5. ISP Name → Your GPRS's name → Click "Next"

**New Connection Wizard**

**Connection Name**  
What is the name of the service that provides your Internet connection?

Type the name of your ISP in the following box.

ISP Name

The name you type here will be the name of the connection you are creating.

< Back   **Next >**   Cancel

Step6. Phone Number: → Click "Next"

**Note:** Phone Number must be provided from your Telecom. CO., LTD.

**For example in Taiwan: \*99#**

**New Connection Wizard**

**Phone Number to Dial**  
What is your ISP's phone number?

Type the phone number below.

Phone number:

You might need to include \*99# or the area code, or both. If you are not sure you need the extra numbers, dial the phone number on your telephone. If you hear a modem sound, the number dialed is correct.

< Back   **Next >**   Cancel

Step7. GPRS's **User name** and GPRS's **Password** → Click "Next"

**Note:** GPRS's **User name** and GPRS's **Password** must be provided from your Telecom. CO., LTD.

**New Connection Wizard**

**Internet Account Information**  
You will need an account name and password to sign in to your Internet account.

Type an ISP account name and password, then write down this information and store it in a safe place. (If you have forgotten an existing account name or password, contact your ISP.)

User name:

Password:

Confirm password:

Use this account name and password when anyone connects to the Internet from this computer.

Make this the default Internet connection.

Turn on Internet Connection Firewall for this connection.

< Back **Next >** Cancel

Step8. Click "Finish"

**New Connection Wizard**

**Completing the New Connection Wizard**

You have successfully completed the steps needed to create the following connection:

**Dial-up Connection**

- Make this the default connection
- This connection is firewalled
- Share with all users of this computer
- Use the same user name & password for everyone

The connection will be saved in the Network Connections folder.

Add a shortcut to this connection to my desktop

To create the connection and close this wizard, click Finish.

< Back **Finish** Cancel

Step9. Control Panel → Network Connections → Click “Your GPRS’s name” →  
File → Properties

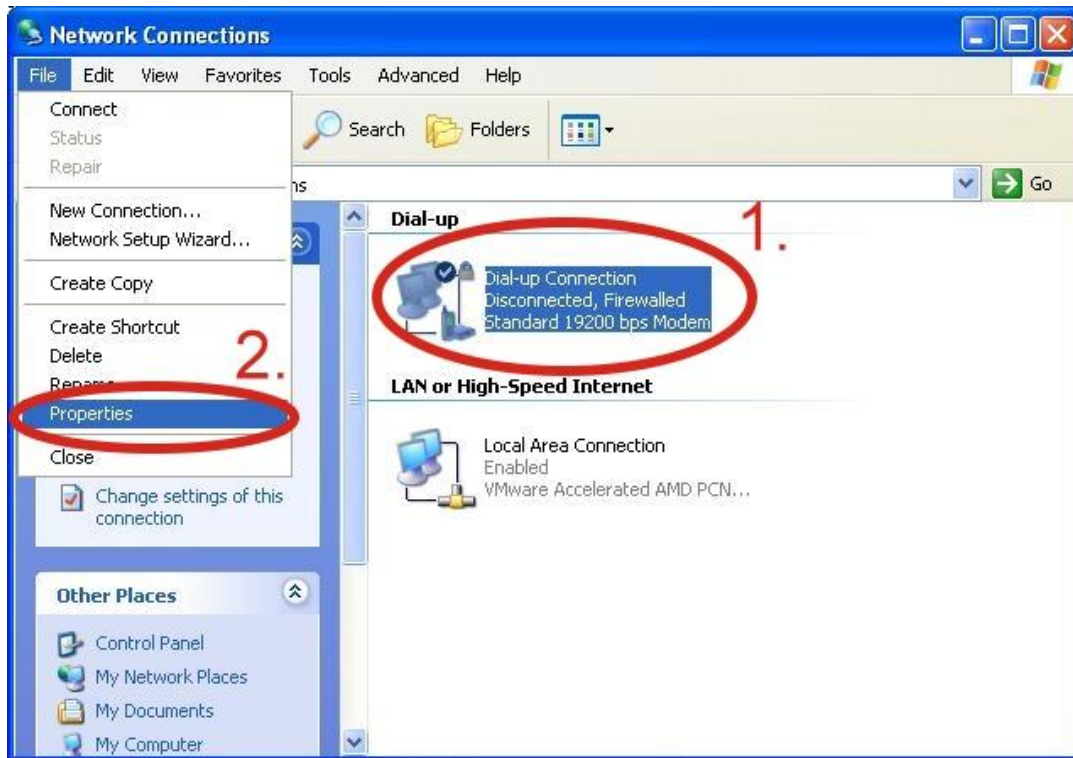

Step10. General → Select "Standard 19200 bps Modem" → Click "Configure"

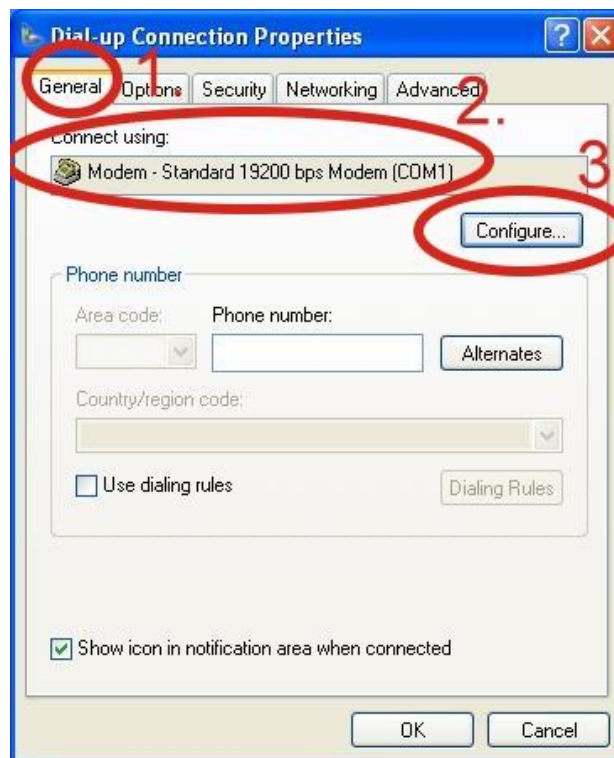

Step11. Maximum speed(bps) → Select "115200" → do not select "Enable hardware flow control " → Click "OK"

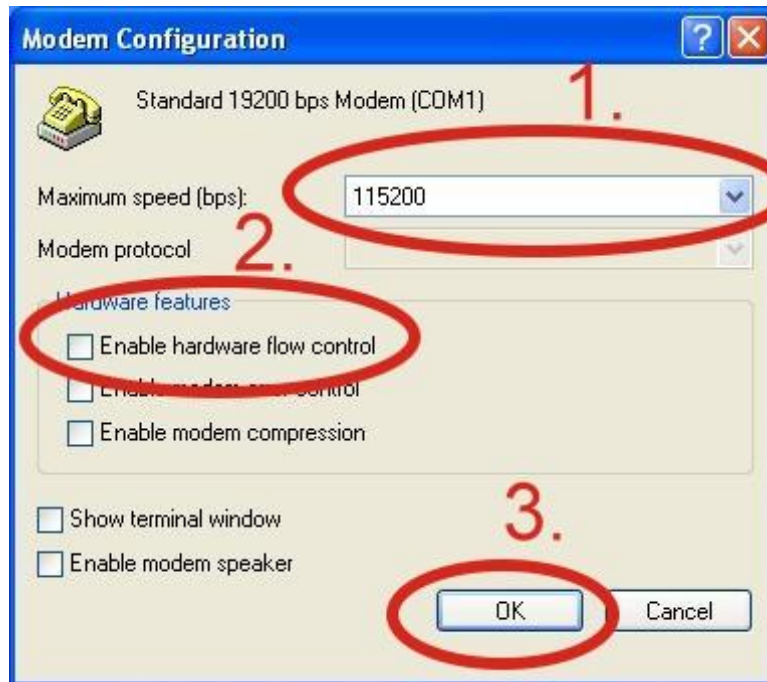

Step12. Click “OK”

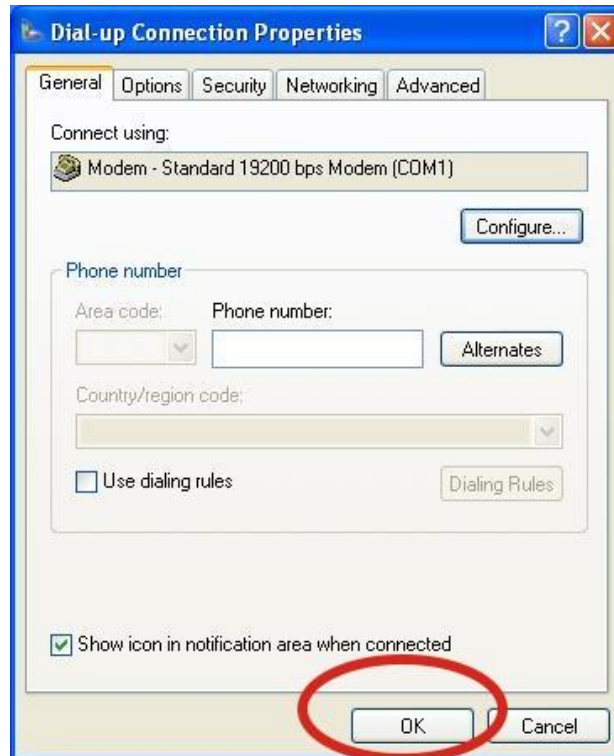

Step13. Control Panel → Network Connections → Double-Click “Your GPRS’s name”

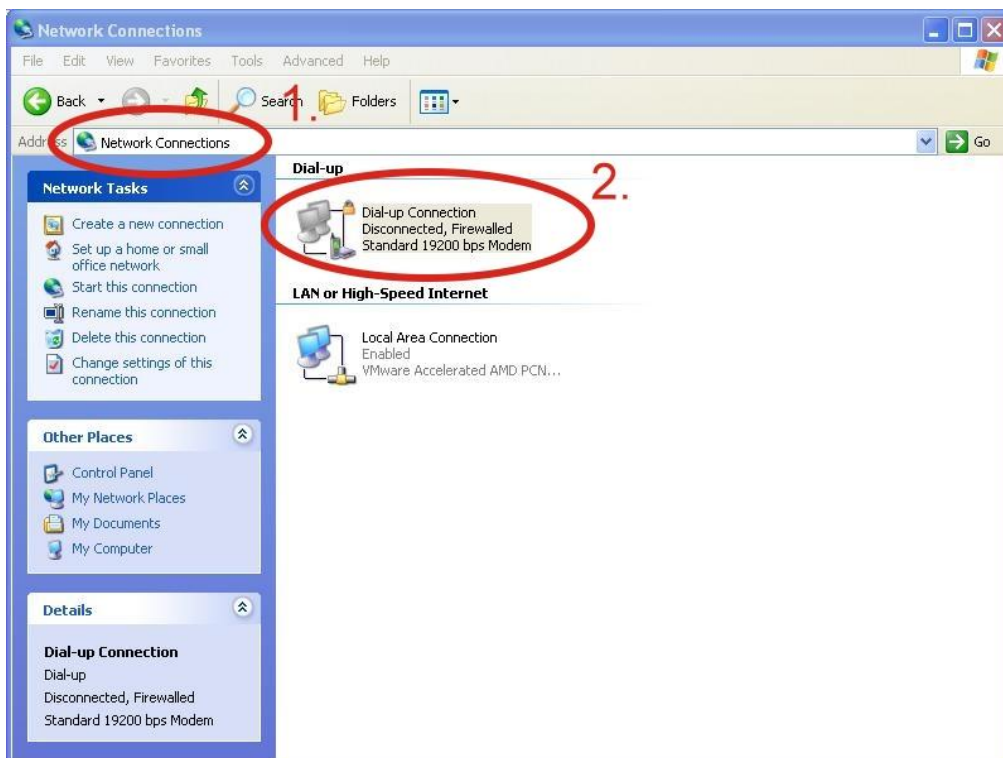

Step14. Click “Dial”



Step15. If you connect to internet successfully, your toolbar have new logo



Step16. You can Double-Click the new logo → Click “Details” → Get your IP address

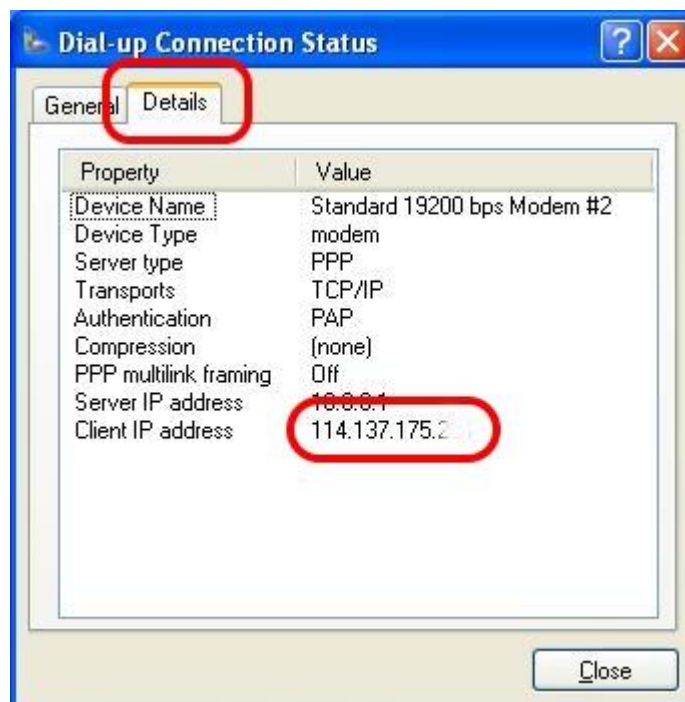

## 6.2 WinPAC-8000 (WinCE 5.0 Based)

➤ Hardware requirement

- 1) I-8212W/I-8213W/ I-8212W-3GWA/I-8213W-3GWA
- 2) WinPAC-8000



WinPAC-8000

+



I-8212W/I-8213W



➤ Create a new modem connection

Step1. Copy “icpdas\_i-821xw\_comx\_v1.xx.cab” to your WinPAC → Double-Click ”  
icpdas\_i-821xw\_comx\_v1.xx.cab” to install →  
Select “OK”

Step2. Execute “WinPAC\_UTILITY” → File → Save and Reboot

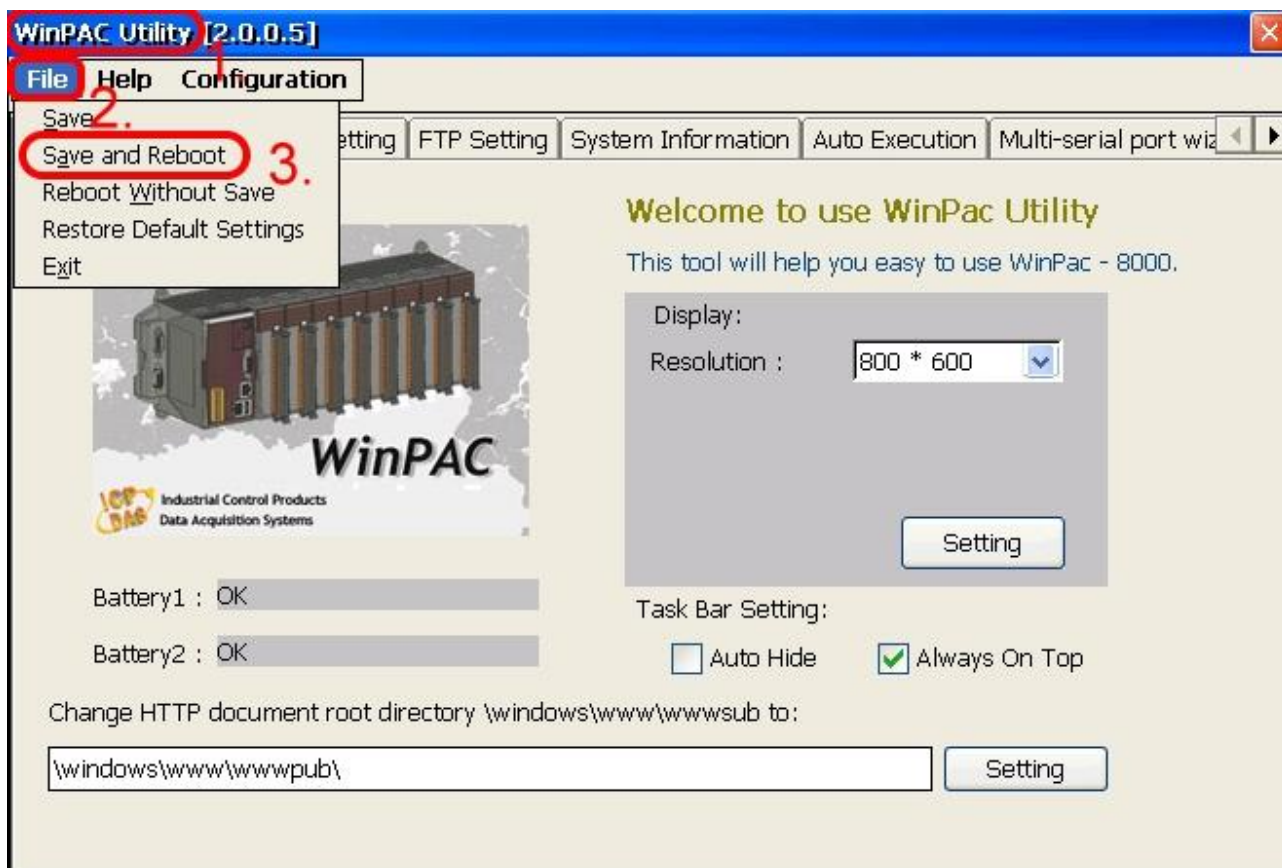

➤ Create a new dial-up and networking connection

Step1. Control Panel → Double-Click "Network and Dial-up Connections"

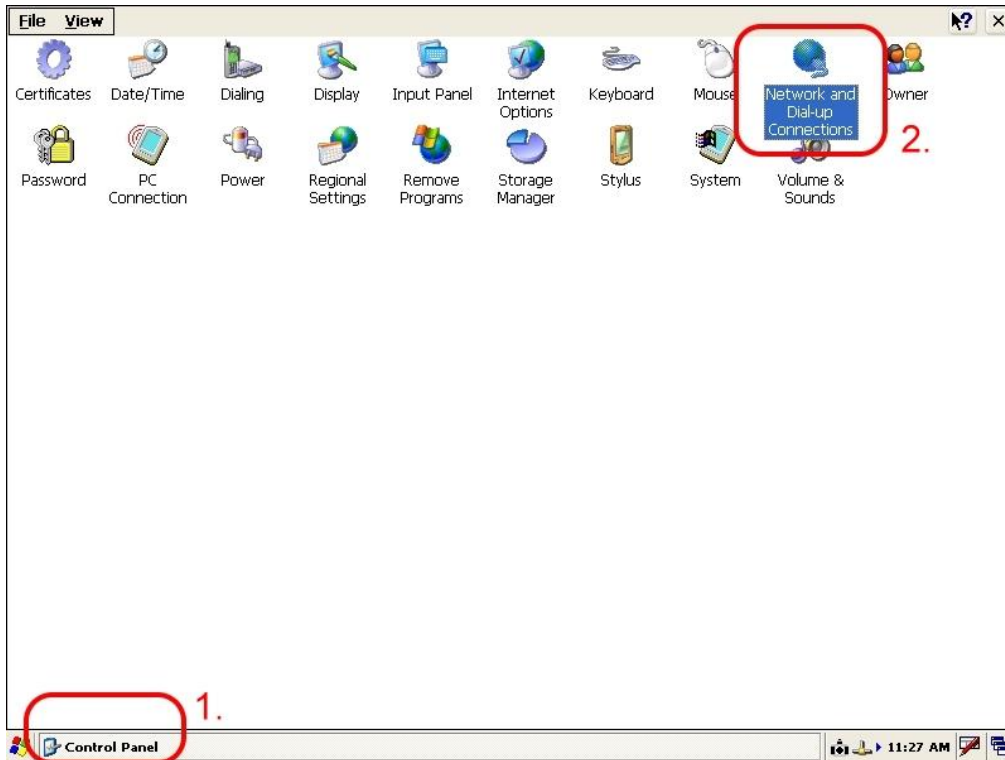

Step2. Double-Click "Make New Connection"

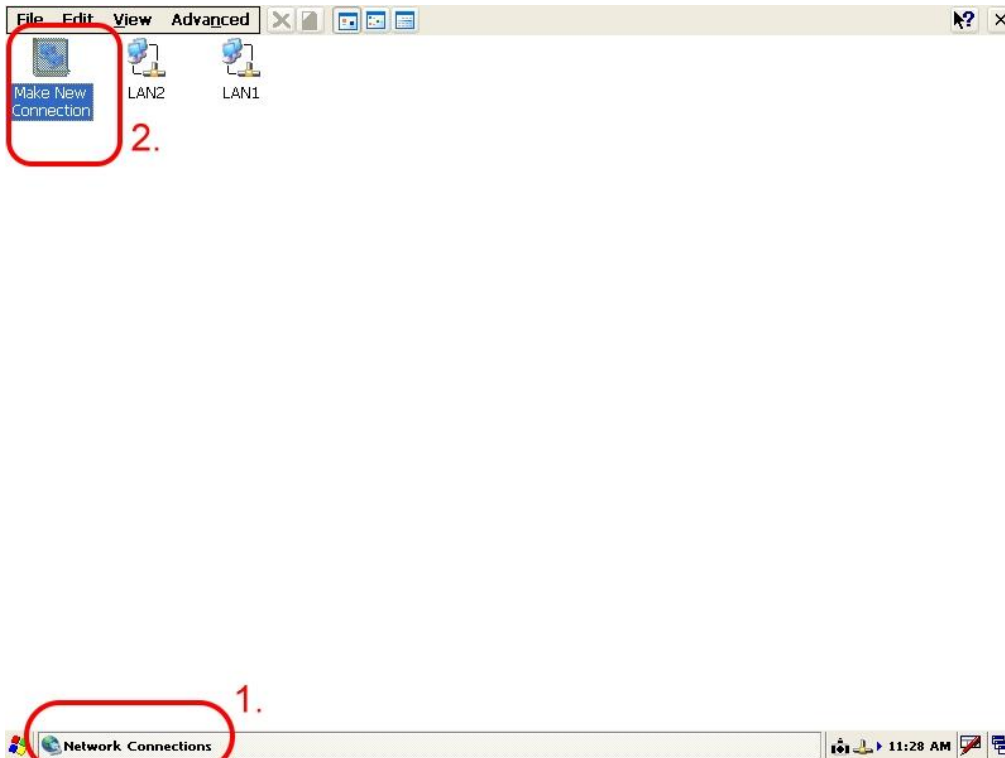

Step3. Key in your name for the connection → Select “Dial-Up Connection” →  
Click “Next”

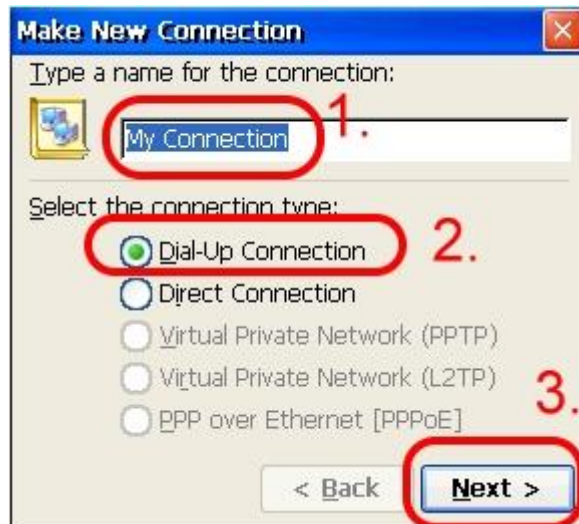

Step4. Select “ICPDAS I-821xW COMx:” → Click “Configure...”

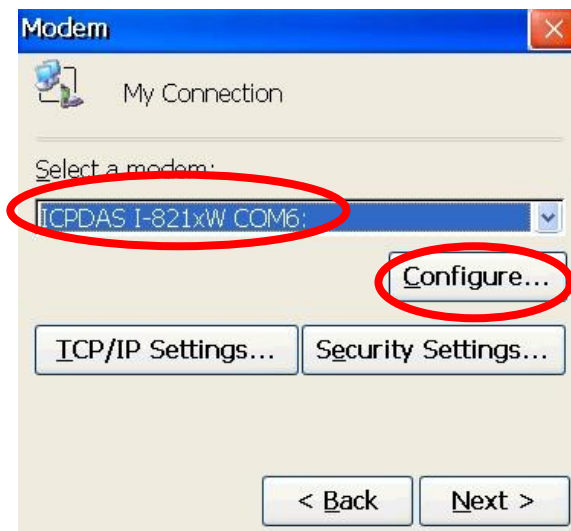

Step5. Select Baud Rate "115200", Data Bits "8", Parity "None", Stop Bits "1" Note and FlowControl "None" → Click "Call Options"



Step6. Extra Settings → Click "OK"

**Note:** GPRS's APN must be provided from your Telecom. CO., LTD.

For example in Taiwan: +CGDCONT=1,"IP","INTERNET"

For example in China: +CGDCONT=1,"IP","CMNET"

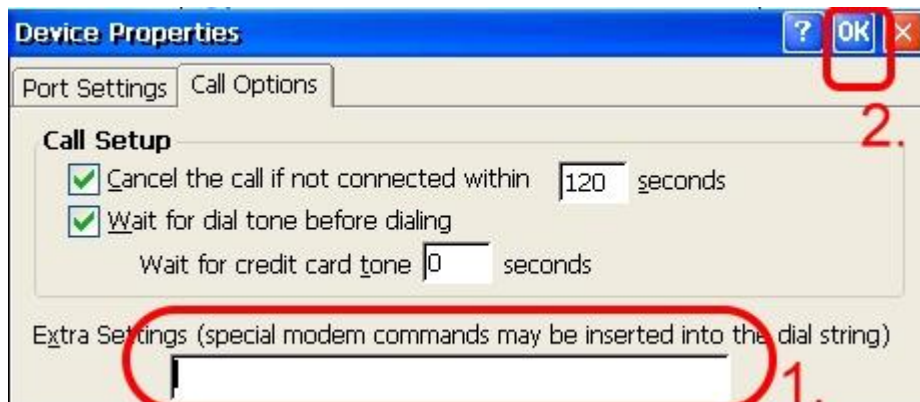

Step7. Click “TCP/IP Settings...”



Step8. TCP/IP Settings: Dependant on the requirement of each ISP.



Step9. Click “Security Settings...”

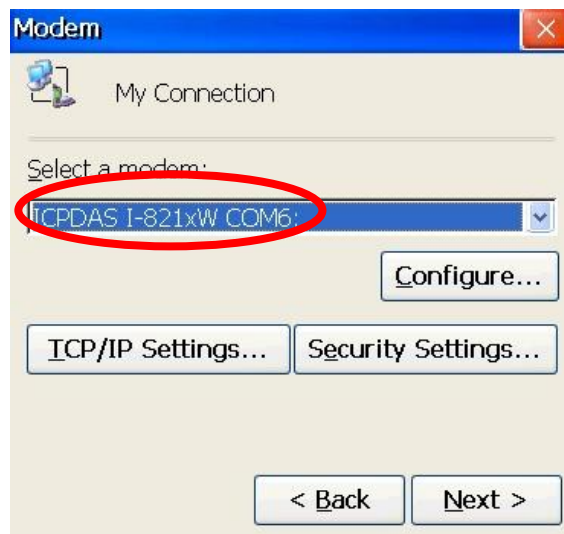

Step10. Security Settings: Dependant on the requirement of ISP ! ( Below picture is the setting for HINET ) .



Step11. Click "Next"

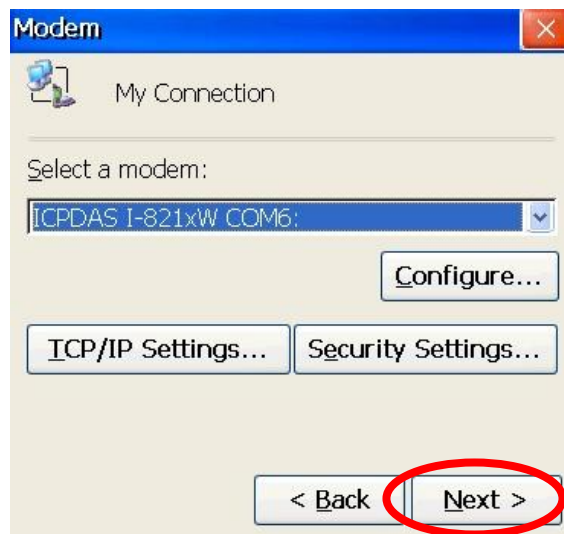

Step12. Phone Number: → Click "Finish"

**Note:** Phone Number must be provided from your Telecom. CO., LTD.

For example in Taiwan: \*99#



## Step13. Double-Click you make new connection name

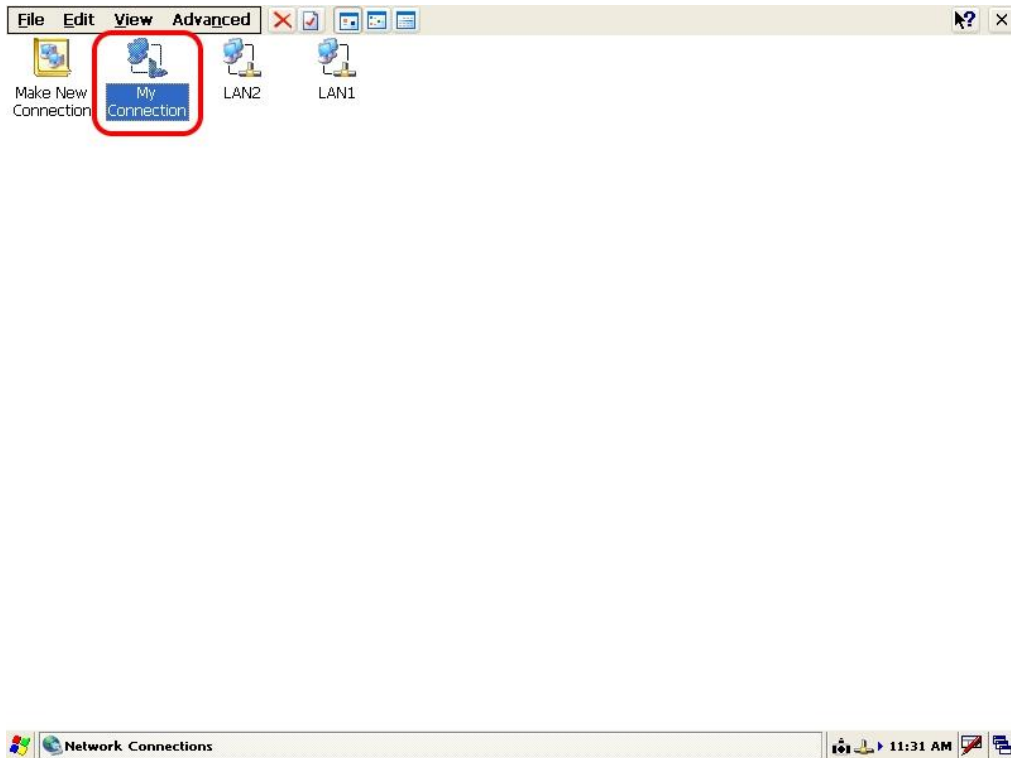

## Step14. Click "Dial Properties..."





Step15. Click “Dialing Patterns...”

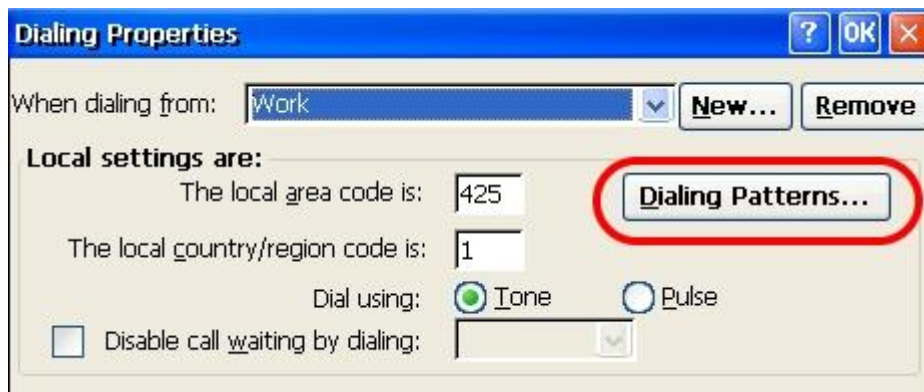

Step16. Key in 'G' to all blocks → Click “OK”

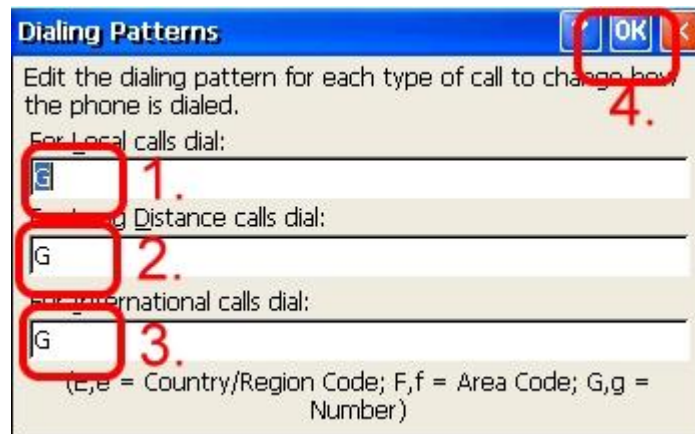

Step17. GPRS's **User name** and GPRS's **Password** → Click “Connect”

**Note:** GPRS's **User name** and GPRS's **Password** must be provided from your Telecom. CO., LTD.



Step18. If you connect to internet successfully, they will show “**Connected**”



Step19. Execute “WinPAC\_UTILITY” → File → Save and Reboot



## 6.3 LinPAC-8000 (Linux kernel 2.6 based)

➤ Hardware requirement

- 1) I-8212W/I-8213W/I-8212W-3GWA/I-8213W-3GWA
- 2) LinPAC-8000



LinPAC-8000

+



I-8212W/I-8213W

➤ Establish a GPRS connection

Modify [/etc/ppp/peers/wavecom](#) to define COM port first. Please follow the steps as below :

(1) Type “ **vi /etc/ppp/peers/wavecom** ”

(2) To find the “Serial device to which the GPRS phone is connected:” statement, and add device name of COM port.

Modify “[/etc/ppp/peers/wavecom](#)”

.....

.....

# Serial device to which the GPRS phone is connected:

# /dev/ttyS0 for serial port (COM1 in Windows),

# /dev/ircomm0 for IrDA,

# /dev/ttyUB0 for Bluetooth (Bluez with rfcmm running) and

# /dev/ttyUSB0 #for USB

**/dev/ttyS34 # serial port one**

# /dev/ttyS0 # serial port one

# /dev/ttyS1 # serial port two

.....

.....

```
# Serial device to which the GPRS phone is connected:
# /dev/ttyS0 for serial port (COM1 in Windows),
# /dev/ircomm0 for IrDA,
# /dev/ttyUB0 for Bluetooth (Bluez with rfcmm running) and
# /dev/ttyUSB0 #for USB
/dev/ttyS34 # serial port one → Connect the GPRS to the COM4
#/dev/ttyS0 # serial port one
#/dev/ttyS1 # serial port two
#/dev/ircomm0 # IrDA serial port one
#/dev/rfcomm0 # Bluetooth serial port one
#/dev/ttyUSB0 # USB serial device, for example Orange SPV
```

## ➤ I-8212W/ I-8212W-3GWA

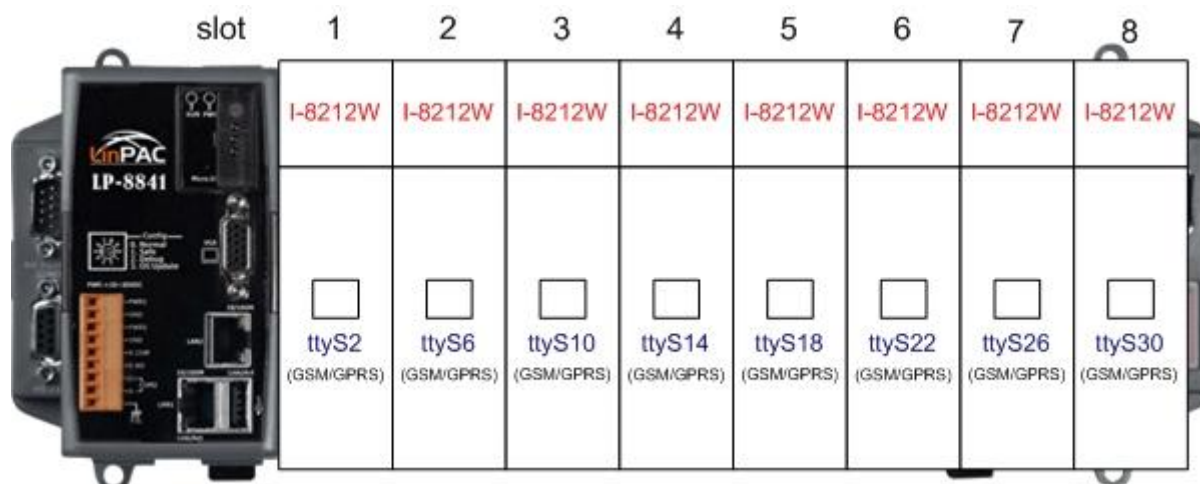

## ➤ I-8213W/ I-8213W-3GWA

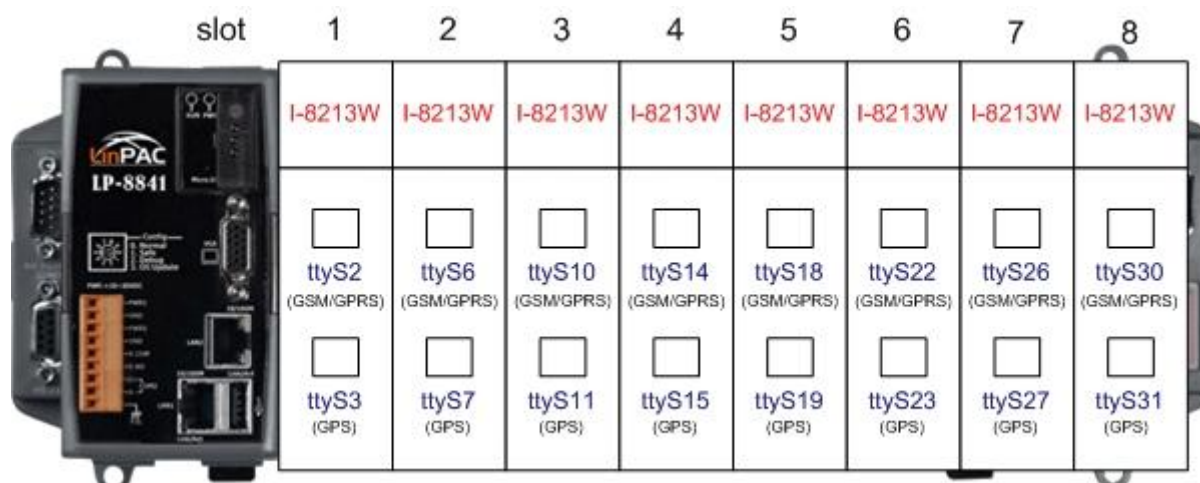

(3) Type “ :wq ” to save and quit the script.

The default GPRS baudrate is “ **115200** ” in the LinPAC, so if users finish the setting of gprs modem and connect the gprs modem to the COM port of LinPAC-8000, just type in “ **pppd call wavecom** ” and then LinPAC-8000 will be connected to the internet automatically. Remember that the network interface card of LinPAC should stop first, just type in “ **ifdown eth0** ” to stop it. If users type in “ **ifconfig** ” will see the “ **ppp0** ” option.

## Chapter 7 Quick test GPS (I-8213W /I-8213W-3GWA only)

### 7.1 XP-8000 (Windows Embedded Standard 2009)

1. Copy the tested software (Send232.exe) to your XP-8000 from the CD

Path: CD:\ gprs\_gsm\_modem\I-8212W\_I-8213W\Software\XP-8000\GPSTest

2. Execute the tested software and select your port number of on your XP-8000, then you will get GPS data.

**Note: The default setting of GPS module is as follows.**

Parameters	Default value
Baud rate	9600 bps
Parity	None
Date bit	8
Stop bit	1

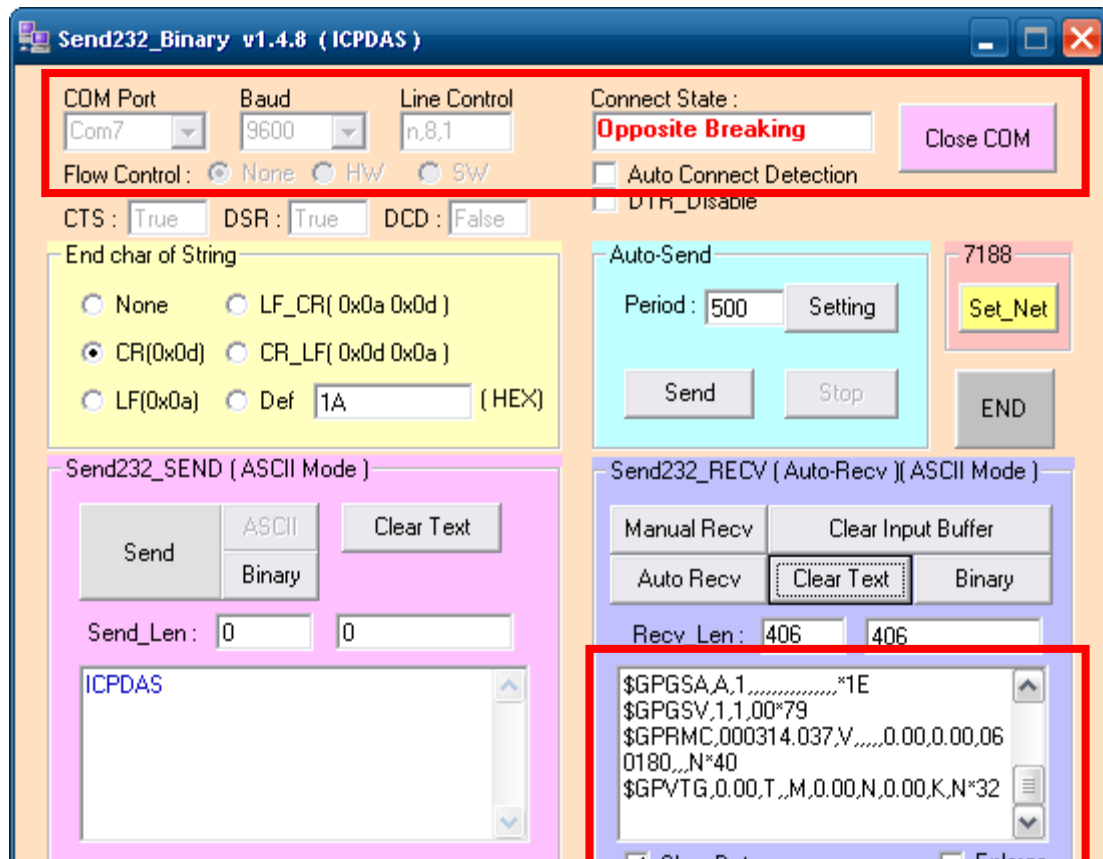

## 7.2 WinPAC-8000 (WinCE 5.0 Based)

1. Copy the tested software (SendToCOM.exe) to your WinPAC-8000 from the CD

Path: [CD:\gprs\\_gsm\\_modem\I-8212W\\_I-8213W\Software\WP-8000\GPSTest](#)

2. Execute the tested software and select your port number of on your WinPAC-8000, then you will get GPS data.

**Note: The default setting of GPS module is as follows.**

Parameters	Default value
Baud rate	9600 bps
Parity	None
Date bit	8
Stop bit	1

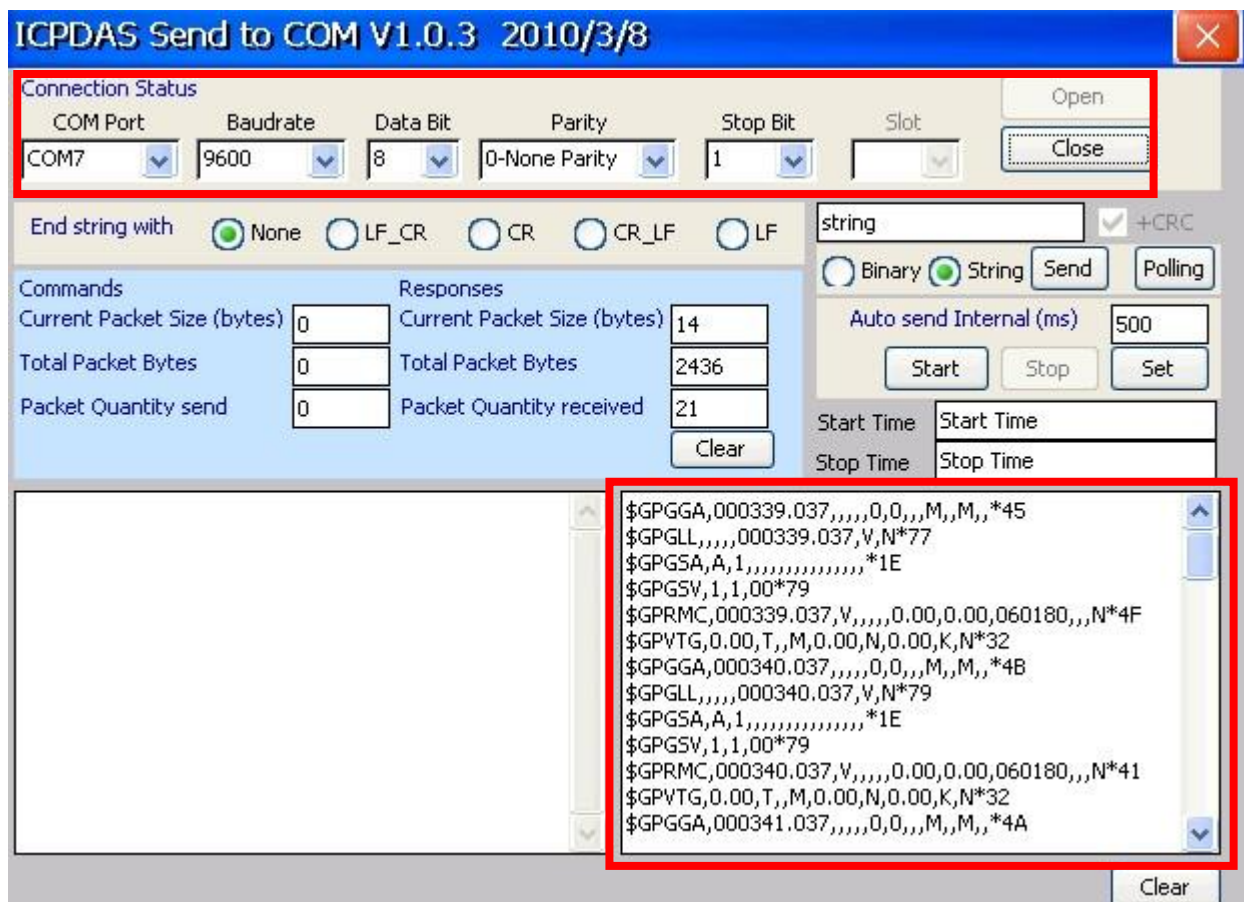

## 7.3 iPAC-8000 (miniOS7 Based)

1. Download the tested software (GPS.exe) to your iPAC-8000 from the CD

Path: CD:\gprs\_gsm\_modem\I-8212W\_I-8213W\Software\iPAC-8000\GPSTest

2. Execute the tested software and type your port number of on your iPAC-8000, then you will get GPS data.

**Note: The default setting of GPS module is as follows.**

Parameters	Default value
Baud rate	9600 bps
Parity	None
Date bit	8
Stop bit	1

```

C837_U2_UDP>run
8000a.Lib vesion 2.0C, Date:Jan 14 2011

*****
|                                     |
|           GPS Demo for I-8213W     |
|                                     |
|*****
Type your GPS prot and press [Enter]: 6
$GPGGA,000040.036,,,,,0,0,,M,M,,*49
$GPGLL,,,,,000040.036,U,N*7B
$GPGSA,A,1,,,,,,,,,,,,,*1E
$GPGSU,1,1,00*79
$GPRMC,000040.036,U,,,,,0.00,0.00,060180,,N*43
$GPUTG,0.00,T,,M,0.00,N,0.00,K,N*32
$GPGGA,000041.036,,,,,0,0,,M,M,,*48
$GPGLL,,,,,000041.036,U,N*7A
$GPGSA,A,1,,,,,,,,,,,,,*1E
$GPGSU,1,1,00*79
$GPRMC,000041.036,U,,,,,0.00,0.00,060180,,N*42
$GPUTG,0.00,T,,M,0.00,N,0.00,K,N*32
$GPGGA,000042.036,,,,,0,0,,M,M,,*4B
$GPGLL,,,,,000042.036,U,N*79
$GPGSA,A,1,,,,,,,,,,,,,*1E
$GPGSU,1,1,00*79

```



## 7.4 LinPAC-8000 (Linux kernel 2.6 based)

Type “cat /dev/ttySn”. The ttySn represents the GPS port number of the I-8213W

**Note: The default setting of GPS module is as follows.**

Parameters	Default value
Baud rate	9600 bps
Parity	None
Date bit	8
Stop bit	1

```
# cat /dev/ttyS3
$GPGGA,000037.036,,,,,0,0,,M,,M,,*49
$GPGLL,,,,,000037.036,V,N*7B
$GPGSA,A,1,,,,,,,,,,,,,*1E
$GPGSV,1,1,00*79
$GPRMC,000037.036,V,,,,,0.00,0.00,060180,,,N*43
$GPVTG,0.00,T,,M,0.00,N,0.00,K,N*32
$GPGGA,000038.036,,,,,0,0,,M,,M,,*46
$GPGLL,,,,,000038.036,V,N*74
$GPGSA,A,1,,,,,,,,,,,,,*1E
$GPGSV,1,1,00*79
$GPRMC,000038.036,V,,,,,0.00,0.00,060180,,,N*4C
```

## Revised Note:

Version	By	Date	Description
1.00	Yide	2011/03/10	Release
1.01	Malo	2011/08/15	Add 3G module
1.02	Malo	2011/12/28	Modify title name