

i-7550 PROFIBUS to RS232/RS485/RS422

Quick Start User Guide

1. Introduction

This manual introduces i-7550's basic setting and operating quickly, the user can refer to i-7550 user manual in the ICP DAS companion CD-ROM (Path: "CD: \PROFIBUS\Converter\i-7550\ manual\i-7550 user manual.pdf").

This manual helps users to understand about the i-7550 module and application that data exchange between PROFIBUS and RS-232/422/485 quickly. Here we use hilscher CIF50-PB PROFIBUS communication interface and i-7550 module to show the application example of PROFIBUS to RS-232 converter, as shown in figure below.

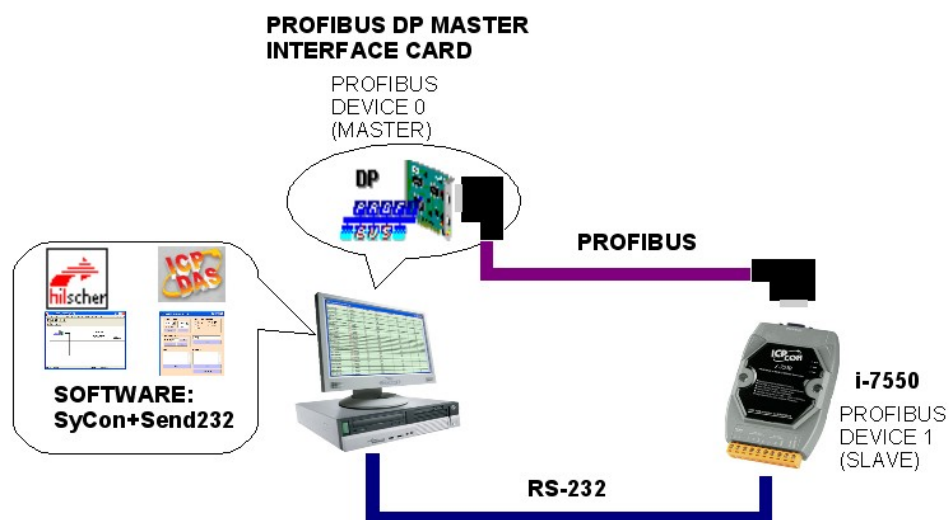

Application example of PROFIBUS to RS-232 converter

When the i-7550 module receives a message from PC's COM Port, i-7550 module can send the message to the data input area of PROFIBUS master station. If it outputs a message from PROFIBUS master station, i-7550 module can also transfer the message to PC's COM Port.

2. Hardware configuration

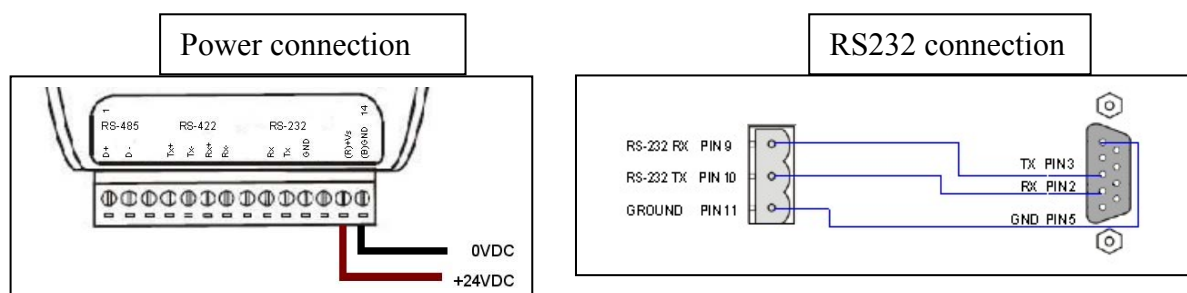

PROFIBUS connection

Here we recommend users to use the standard PROFIBUS cable and connector (DB9 male). It is only needed to use D-type connector via PROFIBUS cable to connect PROFIBUS master station and i-7550 module. PROFIBUS master station and i-7550 module belong to terminal equipments in this example, thus we need to enable the terminator resistor in the D-type connector.

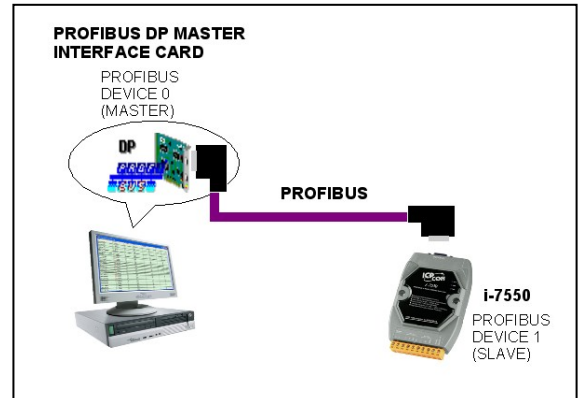

Address setting

The i-7550 is a slave device of PROFIBUS DP protocol. The station address of i-7550 can be set by dip switch. The dip switch can be seen by open the cover, as shown in the below. The range of dip switch is 0~126, here we set i-7550 module's dip switch to 1.

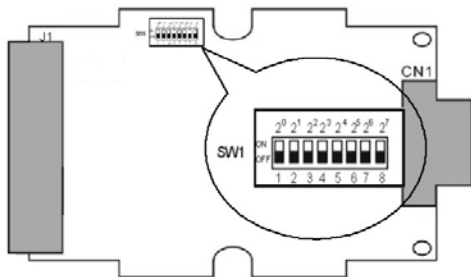

從站位址	DIP SWITCH(SW1)							
	1	2	3	4	5	6	7	8
1	1	0	0	0	0	0	0	0
10	0	1	0	1	0	0	0	0
31	1	1	1	1	1	0	0	0

LED 狀態顯示

LED	Status	Description
PWR	flash	Power supply is ok. COM Port is transmitting or receiving data.
	on	Power supply is ok. The firmware have loaded.
	off	Power supply have failed.
ERR	on	The connection is error with PROFIBUS master device or PROFIBUS system configuration is not correct.
	off	PROFIBUS system configuration is correct. It is normal operation.
RUN	on	Data exchange mode. It is normal operation.
	off	i-7550 module is not in data exchange mode.

3. Establish connection with i-7550

Before establish the connection between DP-Master and i-7550, users should obey the following steps first.

1. First, users must load the electronic device description file (GSD file) of the i-7550 into the DP-Master.
2. And, then set the parameters.
3. Finally change your DP-master from Offline state to Operate state. The i-7550 will be initialized. If there is no error occurs, i-7550 proceeds into data exchange state. At the meantime, if there is any error occurs, i-7550 will return to wait for parameterization.

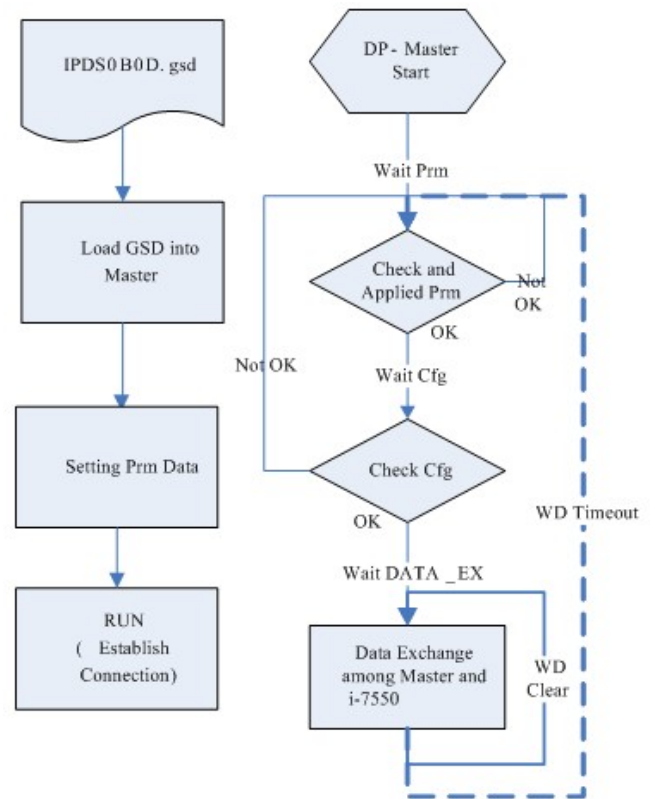

4. Software configuration

GSD file

Please copy IPDS0B0D.gsd and ICP_7550.bmp in the ICP DAS companion CD-ROM(PATH : "CD: \PROFIBUS\ Converter\i-7550\GSD") to PROFIBUS configuration tool (This software is provided by PROFIBUS master device or PROFIBUS master device recommends to use).

➤ the example of how to load GSD file

Here, we use the hilscher CIF50-PB PROFIBUS communication interface to show how to load i-7550's GSD file step by step.

Step 1: Click insert slave button in the PROFIBUS configuration tool.

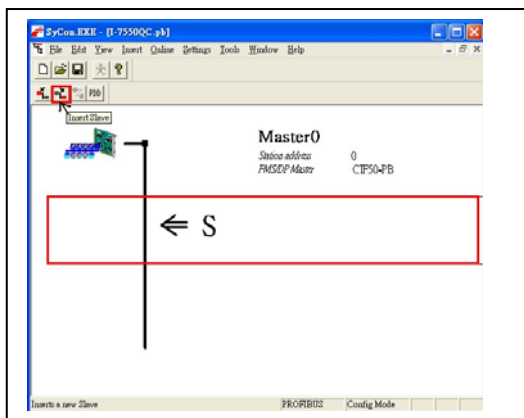

Step 2: Choose i-7550 device and click Add button.

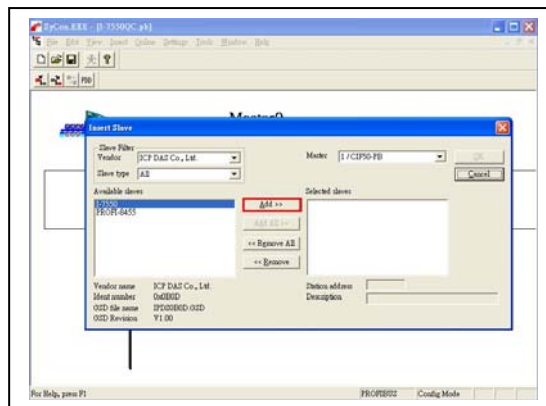

Step 3: Set address of i-7550 and then click OK button.

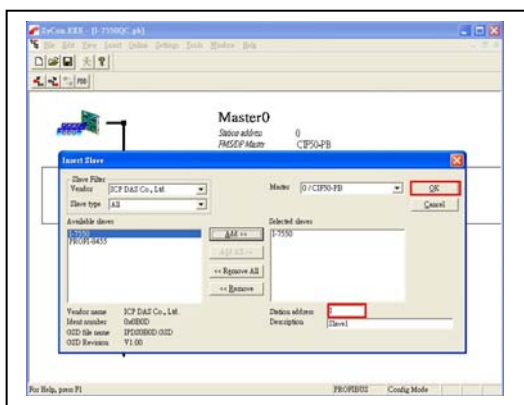

Step 4: Finish adding i-7550 in the DP-master interface.

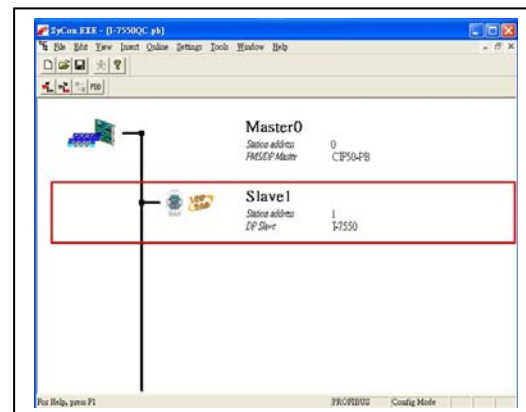

➤ Setting the parameters of the i-7550

Here, we use the default value (baud rate: 115200, parity: none, data: 8 data bit, end char of input data: CR, input fixed length data: disable) in this example. Please refer to section 3.3 of i-7550 user manual for detail. It is not needed to change any the parameters of the i-7550 in this demo.

➤ Setting the configuration of the i-7550

The settings of the i-7550 are described below.

- System setting module : 4 byte out, 2 byte in

- Output module : 1~16 byte out, 1~16 word out
- Input module : 1~16 byte in, 1~16 word in

In this example, we configure a “system setting module”, a “8 Byte In module” and a “8 Byte Out module” shown below.

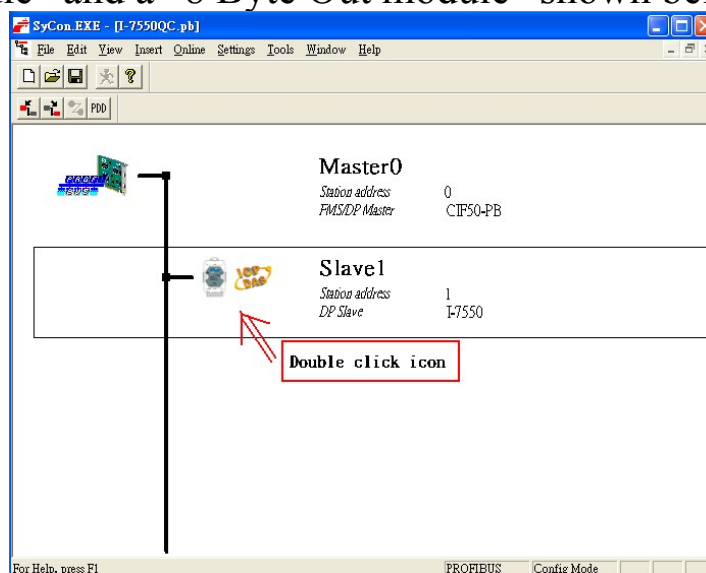

Double click i-7550's icon to enter Slave configuration dialog

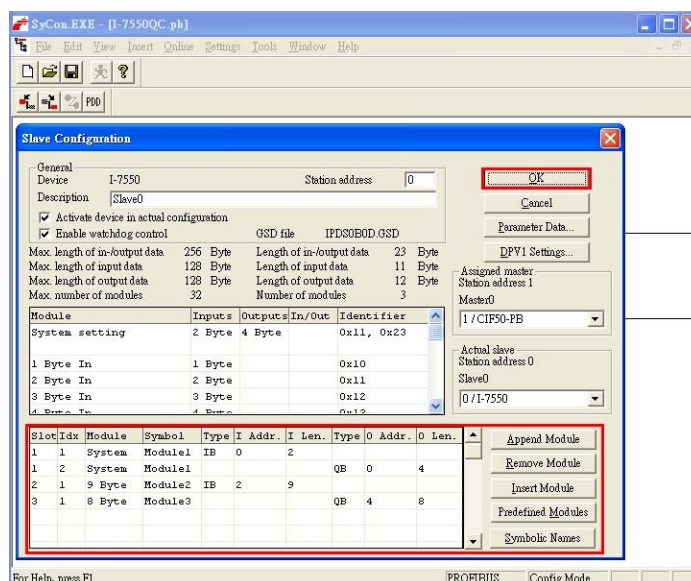

Configure module and click OK button

When finishing the process of the i-7550's configuration and saving in the PROFIBUS master successfully, the 'RUN' LED indicator of i-7550 is turned on. That shows the i-7550 working in the data exchange mode.

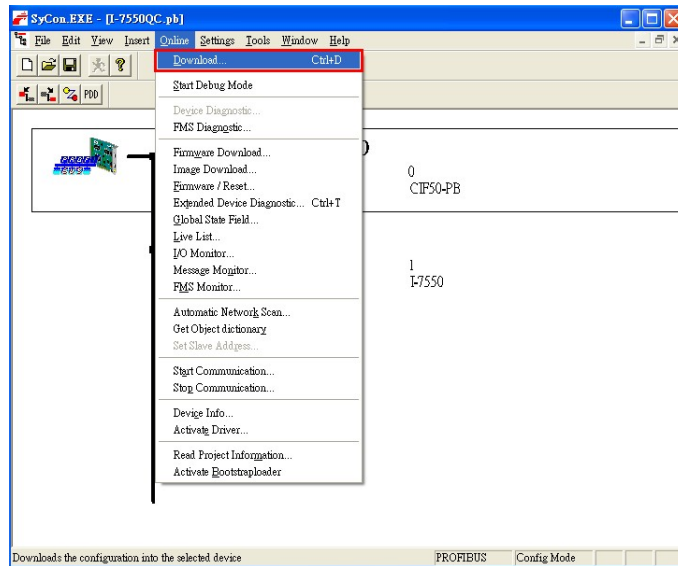

Click <Online->Download> to download the setting into PROFIBUS master station

5. i-7550 module communication test

This demo uses Send232 software on the PC to communicate with the i-7550. Users can get it from the ICP DAS companion CD-ROM(PATH:“CD: \PROFIBUS\Converter\i-7550\utilities\send232”). The Send232’s setting is shown in the below.

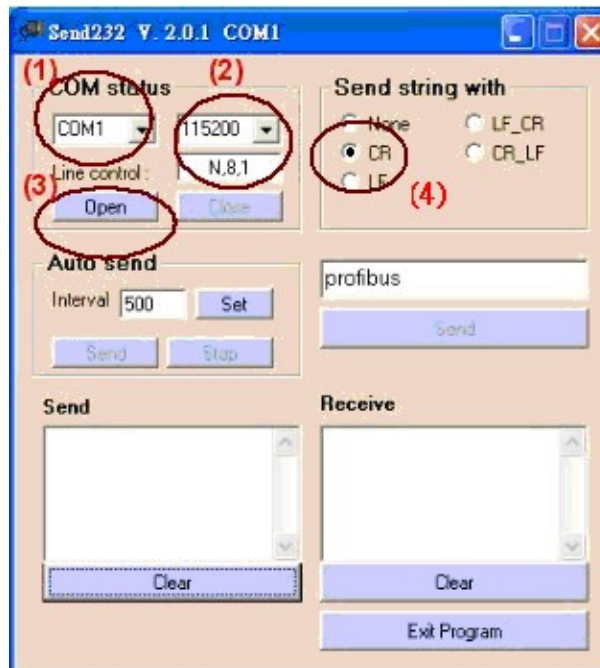

Send232 operate procedure

➤ PROFIBUS input test

The users can send "profibus" string in this software from the serial port of the PC. Then the PROFIBUS master interface can receives "profibus" string in the input data area, as shown in the below.

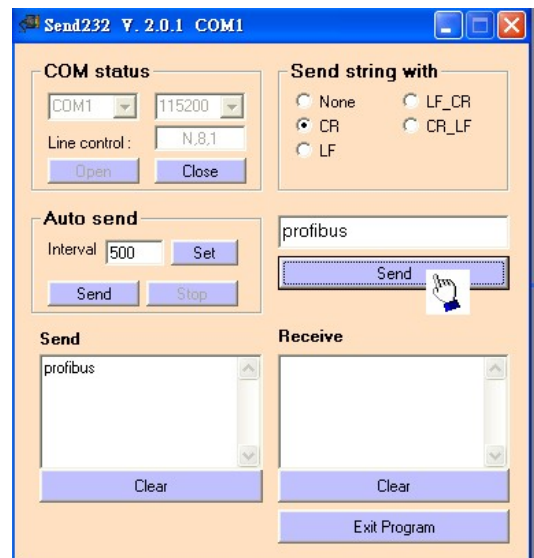

Receive "profibus" string in PROFIBUS input data area

<i>Module</i>	<i>Byte</i>	<i>Data type</i>	<i>Representation</i>	<i>Value</i>	<i>Representation</i>	<i>Value</i>
1	Input 0	Byte	Hex	0x00	Hex	0x00
1	Input 1	Byte	Hex	0x08	Hex	0x09
2	Input 2	Byte	Hex	0x70	Char	p
2	Input 3	Byte	Hex	0x72	Char	r
2	Input 4	Byte	Hex	0x6F	Char	o
2	Input 5	Byte	Hex	0x66	Char	f
2	Input 6	Byte	Hex	0x69	Char	i
2	Input 7	Byte	Hex	0x62	Char	b
2	Input 8	Byte	Hex	0x75	Char	u
2	Input 9	Byte	Hex	0x73	Char	s
2	Input 10	Byte	Hex	0x0D	Hex	0x0D

➤ PROFIBUS output test

It is needed to set "8" (output data length) in the second byte and

"profibus" (output data) in the 5th to 12th bytes of the PROFIBUS output data area in the PROFIBUS master interface. Then set the value of the first byte from 0 to 1 to trigger the data output command. The Send232 software can show the receiving data form the i-7550 as shown in the below.

Send "profibus" string in PROFIBUS output data area

<i>Module</i>	<i>Byte</i>	<i>Data type</i>	<i>Representation</i>	<i>Value</i>	<i>Representation</i>	<i>Value</i>
1	Output 0	Byte	Hex	0x00 → 0x01	Hex	0x00 → 0x01
1	Output 1	Byte	Hex	0x08	Hex	0x08
1	Output 2	Byte	Hex	0x00	Hex	0x00
1	Output 3	Byte	Hex	0x00	Hex	0x00
3	Output 4	Byte	Hex	0x70	Char	p
3	Output 5	Byte	Hex	0x72	Char	r
3	Output 6	Byte	Hex	0x6F	Char	o
3	Output 7	Byte	Hex	0x66	Char	f
3	Output 8	Byte	Hex	0x69	Char	i
3	Output 9	Byte	Hex	0x62	Char	b
3	Output 10	Byte	Hex	0x75	Char	u
3	Output 11	Byte	Hex	0x73	Char	s

