



Quick Start for XP-8000

Mar 2009, Version 1.9 written by Kyon and Anna, revised by Jose

Foreword

The purpose of this Quick Start is to help you quickly start to use the XP-8000 and have a rough understanding with processes of application installation and setting I/O modules.

Table of Contents

1. What's on Your Package?	2
2. Preparing for Start-up Your XP-8000.....	2
3. Connecting to Power and Peripherals.....	3
4. Inserting I/O Modules	3
5. Using DCON Utility to Configure I-87K Series I/O Modules	4
6. How to Install Applications.....	5
7. Recover Your XP-8000 to Factory Default	6
8. Technical Support	8

What's on your package?

Item	Quantity	Model No.	Description
XP-8000	1	XP-8041	XP-8041: 0 slot
		XP-8341	XP-8341: 3 slots
		XP-8741	XP-8741: 7 slots
Manual	1	-	Quick Start Guide (this manual)
CD	1	-	Software and documents included.
Screw Driver	1	1C016	2.4 mm Screw driver

Preparing for start-up your XP-8000

1. Power Supply: +10 ~ +30 VDC (Ex: DP-665)

http://www.icpdas.com/products/Accessories/power_supply/power_list.htm

2. Monitor: 640 x 480 ~ 1600 x 1200

3. USB mouse and USB keyboard

Connecting to power and peripherals

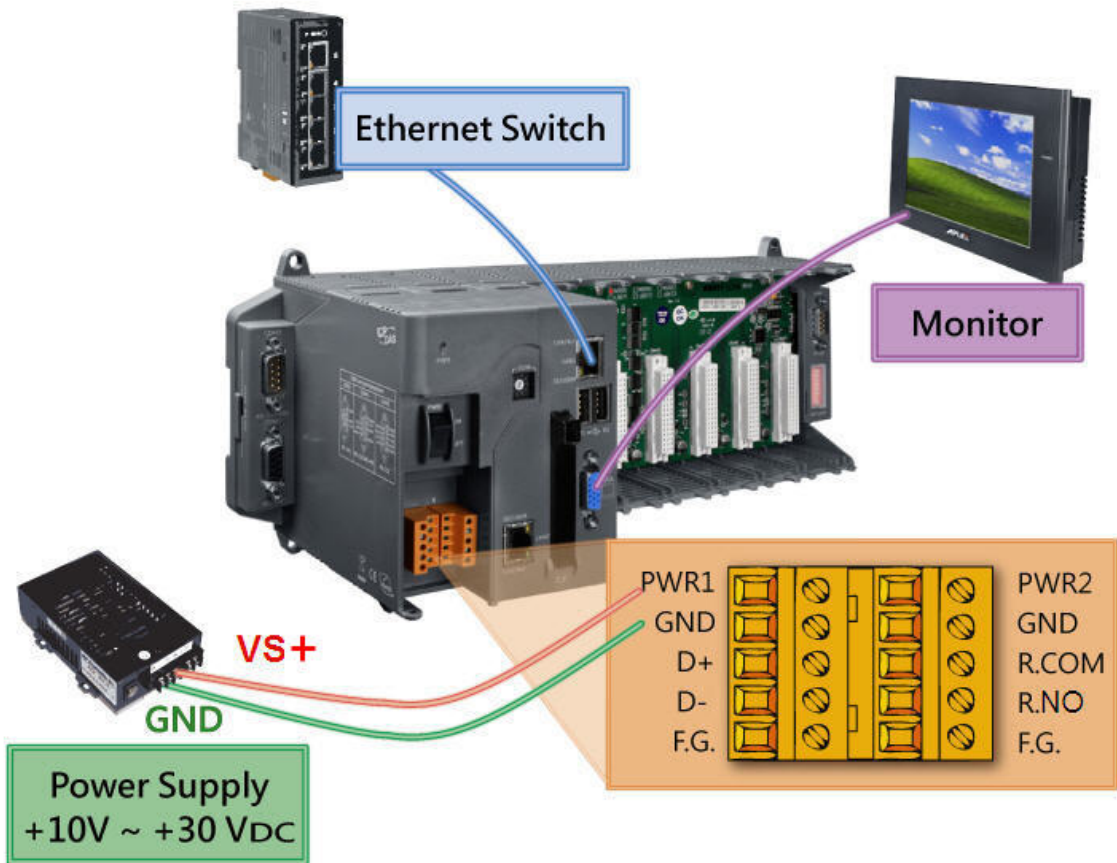

Inserting the I/O module(s)



High profile I-8K and I-87K modules only

Using DCON Utility to configure I-87K modules

The DCON Utility is already included in your XP-8000. Configure I-87K modules as the following steps.

1. Double-click on the shortcut on the desktop.



2. Click Search button.

3. Click the name of the module you want to configure it.

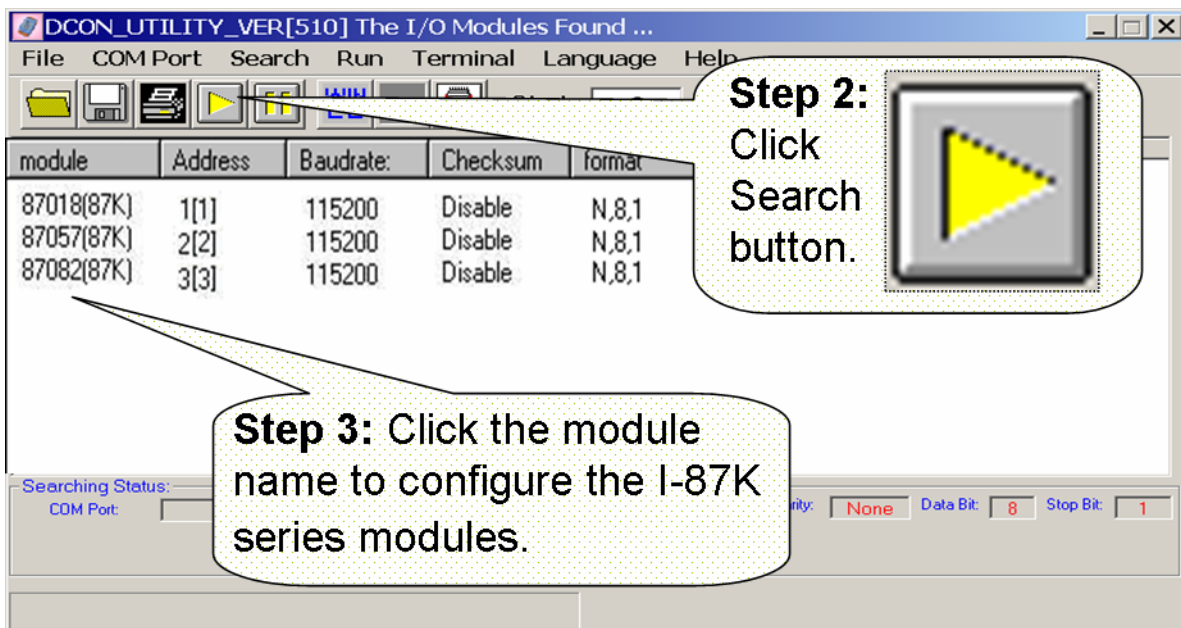

Installing application and saving system settings modified

The XP-8000 provides a safety mechanism: **EFW** for protecting the system from virus infection and harsh environments. Before installing application and modifying system settings, EWF need be disabled; after the operation completed, EWF need be enabled.

1. Disable EWF:

a. Reboot XP-8000.

b. Click “**Run**” on the start menu, type “**cmd**” in the Run dialog and press **OK** button to run the terminal application.

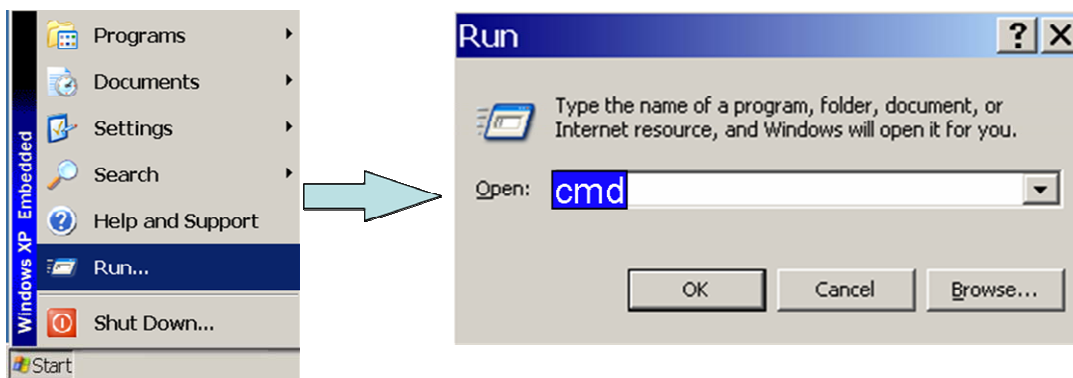

c. execute disable command below in terminal application:

efwfmgr c: -commitanddisable –live

2. Install your applications or modify the system settings.

3. Enable EWF

Execute enable command below in terminal application:

efwfmgr c: -enable

4. Reboot the XP-8000 and execute your application.

Recovering your XP-8000 to factory default

1. Reboot your XP-8000. While rebooting, press “**delete**” key to enter BIOS setup utility.
2. Choose “**Advanced BIOS Features**” and then press “**Enter**” key.

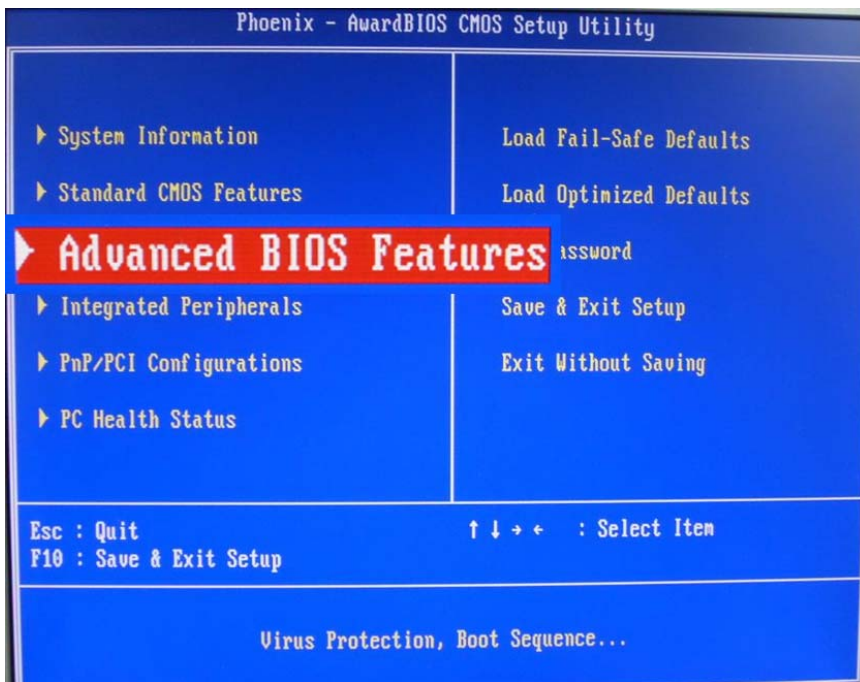

3. Set “**First Boot Device**” as “**HDD-1**”.

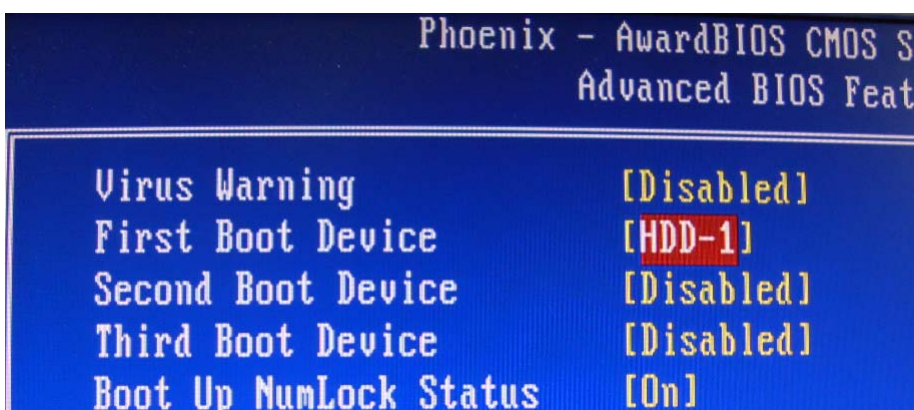

4. Return to main menu and select “**Save and Exit Setup**”.

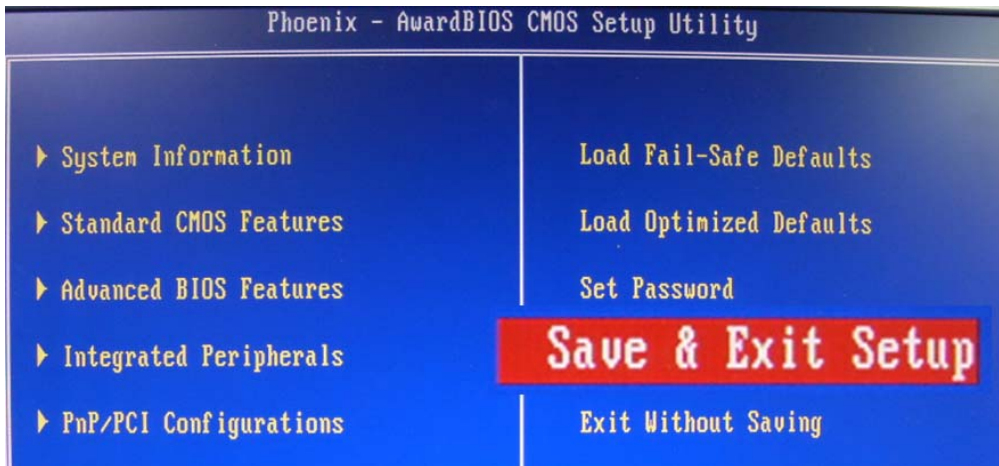

5. Choose **(1)** Recover XP-8000 to factory default.

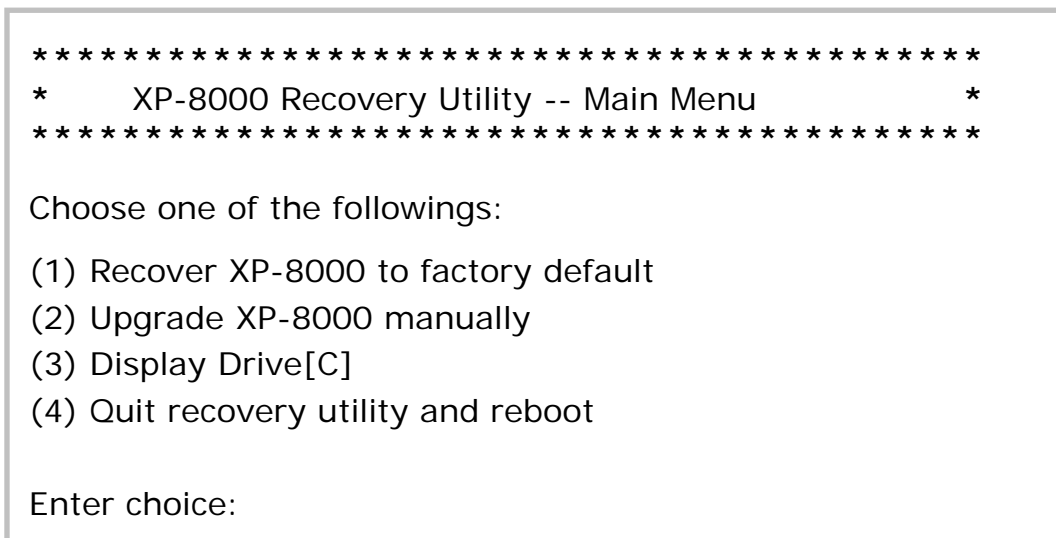

6. Wait about 20 min for recovery process, then choose **(4)**, Quit recovery utility and reboot. (Refer to above figure.)

7. Repeat step 1 ~ 4 to set “**First Boot Device**” as “**HDD-0**” (and reboot XP-8000).

The XP-8000 will set itself default when the first reboot after recovery procedure. It needs about 8 min.

8. Follow the reboot request and then the XP-8000 recovery is completed.

Technical support

- **XP-8000 User Manual**

D:\ICPDAS\XP-8000\Document\User_Manual (in companion CF card)

ftp://ftp.icpdas.com/pub/cd/xpac/xp-8000/document/users_manual/

- **XPacSDK API**

D:\ICPDAS\XP-8000\SDK

<ftp://ftp.icpdas.com/pub/cd/xpac/xp-8000/sdk/>

- **XPacSDK API Documents:**

D:\ICPDAS\XP-8000\Document\SDK\

<ftp://ftp.icpdas.com/pub/cd/xpac/xp-8000/document/sdk/>

- **DCON Utility User Manual**

D:\ICPDAS\XP-8000\Tools\DCON_UTILITY\Manual\

ftp://ftp.icpdas.com/pub/cd/xpac/xp-8000/tools/dcon_utility/

- **XP-8000 Website**

<http://www.icpdas.com/products/PAC/xpac/introduction.htm>

- **ICP DAS Service Email Account**

service@icpdas.com