

VDX-6300

VSX-6100-EVB (Evaluation board)

DM&P Vortex86DX 800MHz

DIP 68pin CPU Module

with (3x TX/ RX only)/2USB/LAN/2GPIO/CF/PWMx24

256MB DDR2 Onboard

User's Manual

(Revision 1.0A)

● Copyright

The information in this manual is subject to change without notice for continuous improvement in the product. All rights are reserved. The manufacturer assumes no responsibility for any inaccuracies that may be contained in this document. And makes no commitment to update or to keep current the information contained in this manual.

No part of this manual may be reproduced, copied, translated or transmitted, in whole or in part, in any form or by any means without the prior written permission of the ICOP Technology Inc..

©Copyright 2008 ICOP Technology Inc.

Manual No. IUM6100-EVB000-01 Ver.1.0A ● May, 2008

Manual No. IUM6300000-01 Ver.1.0A ● October, 2009

● Trademarks Acknowledgment

Vortex86DX™ is the registered trademark of ICOP Technology Inc.

Other brand names or product names appearing in this document are the properties and registered trademarks of their respective owners. All names mentioned herewith are served for identification purpose only.

Table of Contents

Table of Contents.....	iii
Chapter 1 Introduction.....	1
1.1 Packing List.....	1
1.2 Product Description.....	1
1.3 Specifications.....	3
1.4 Board Dimension.....	5
Chapter 2 Installation.....	7
2.1 Board Outline.....	7
2.2 Connectors & Jumpers Location.....	8
2.3 Connectors & Jumpers Summary.....	10
2.4 Pin Assignments & Jumper Settings.....	12
2.5 System Mapping.....	20
2.6 Watchdog Timer.....	23
2.7 GPIO.....	24
2.8 SPI flash.....	25
2.9 PWM.....	26
Chapter 3 Driver Installation.....	27
Appendix.....	28
A. TCP/IP library for DOS real mode.....	28
B. BIOS Default Setting.....	29
C. Console redirection Setting.....	30
D. VSX-6100-EVB Schematic.....	35
Warranty.....	36

Chapter 1

Introduction

1.1 Packing List

Product Name	Package
VDX-6300	<ul style="list-style-type: none">● Embedded Vortex86DX DIP 68 Pin CPU Module● RS232 cable x 3● USB cable x 1● PS/2 Keyboard cable x 1

Product Name	Package
VSX-6100-EVB	<ul style="list-style-type: none">● Embedded Vortex86SX/DX DIP 68pin CPU Module Evaluation board x 1● Manual & Drivers CD x 1

Note:

All cables will be included only, when you order the whole set of VDX-6300 and VSX-6100-EVB.

1.2 Product Description

The VDX-6300 family of low-power x86 embedded controller is designed to meet DIP 68pin CPU module specification, and integrated with the following features.

- 800MHz Vortex86DX System-On-Chip
- 256MB DDR2 system memory
- 10/100Mbps Ethernet
- 3 USB 2.0 (host)
- Up to 3 serial ports
- 16-bit GPIO x2
- 2 watchdog timer
- PWM 16~24 channels
- JTAG interface
- AMI BIOS
- Onboard 4MB SPI Flash
- DC IN: +6V~+24V
- Support extended operating temperature range of -20°C to +70°C

The VDX-6300 DIP 68pin controller is designed with backward compatibility in mind, to provide migration path for projects facing end-of-life challenges with their existing x86 based controller. The VDX-6300 family of controller is designed as a plug in replacement, with backward compatibility to support legacy software to help extend existing product life cycle without heavy re-engineering.

VDX-6300 is suitable for broad range of data-acquisition, Industrial automation, Process control, Automotive controller, AVL, Intelligent Vehicle management device, Medical device, Human machine interface, Robotics, machinery control And more... application that required small footprint, low-power and low-cost hardware with open industry standard such as DIP 68pin module.

1.3 Specifications

Features	VSX-6100-EVB (Evaluation board)
Connectors	<ul style="list-style-type: none"> ● 2.00mm Ø10-pin header for RS-232 x1 ● 2.54mm Ø10-pin header for PWM x1 ● 2.54mm Ø10-pin header for GPIO x3 ● 2.54mm Ø 3-pin header for SERVO x8 ● 2.54mm Ø 34-pin connector for Multi-I/O x1 ● External USB connector x2 ● External RJ-45 connector for Ethernet x1 ● External 9-pin D-Sub male connector for RS-232 x1
Power Requirement	+6V~+24V @250mA
Dimension	101mm X 78mm (3.97 x3.07 inches)
76	76g
Operating Temperature	-20°C ~ +70°C -40°C ~ +85°C (Optional)

Features	VDX-6300
CPU	DM&P SoC CPU Vortex86DX- 800MHz Real Time Clock with Lithium Battery Backup
Cache	L1:16K I-Cache, 16K D-Cache L2:128KB Cache
BIOS	AMI BIOS
System Memory	256 /512MB DDR2 Onboard
Watchdog Timer	Software programmable from 30.5 us to 512 seconds x2 sets(Watchdog 1 fully compatible with M6117D)
I /O Interface	<ul style="list-style-type: none"> ● RS-232 port x3 ● USB port x1 (USB 2.0 version)
Connectors	<ul style="list-style-type: none"> ● 1.25mm Ø 3-pin Wafer for RS-232 x3 ● 1.25mm Ø 4-pin Wafer for USB x1 ● 1.25mm Ø 4-pin Wafer for KBD x1 ● 1.25mm Ø 6-pin Wafer for JTAG x1 ● Type I/II Compact Flash slot x1
Flash Disk Support	<ul style="list-style-type: none"> ● Onboard 4MB SPI Flash Disk (Driver: A) ● Type I/II CF Card
Power Requirement	Single Voltage +5V @ 380mA
Dimension	90mm X 46mm (3.54 x1.81 inches)
Weight	30g
Operating Temperature	-20°C ~ +70°C -40°C ~ +85°C (Optional)

1.4 Board Dimension

■ VSX-6100-EVB (Evaluation board)

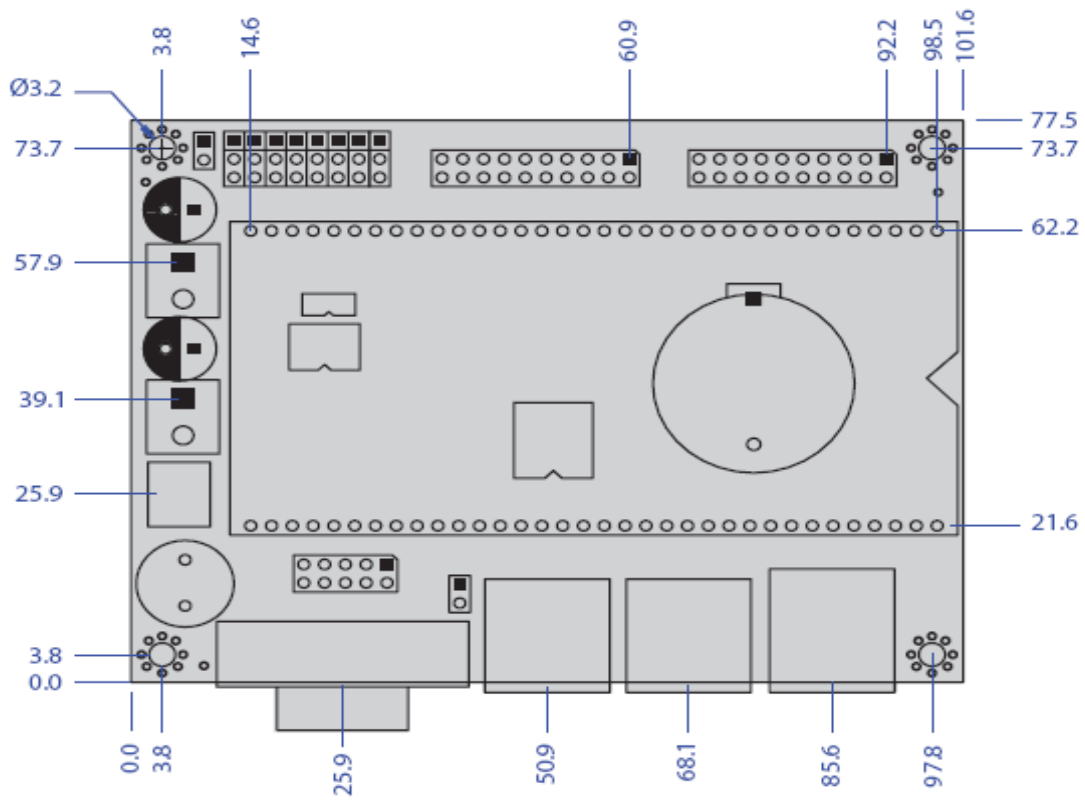

Unit: mm

■ VDX-6300

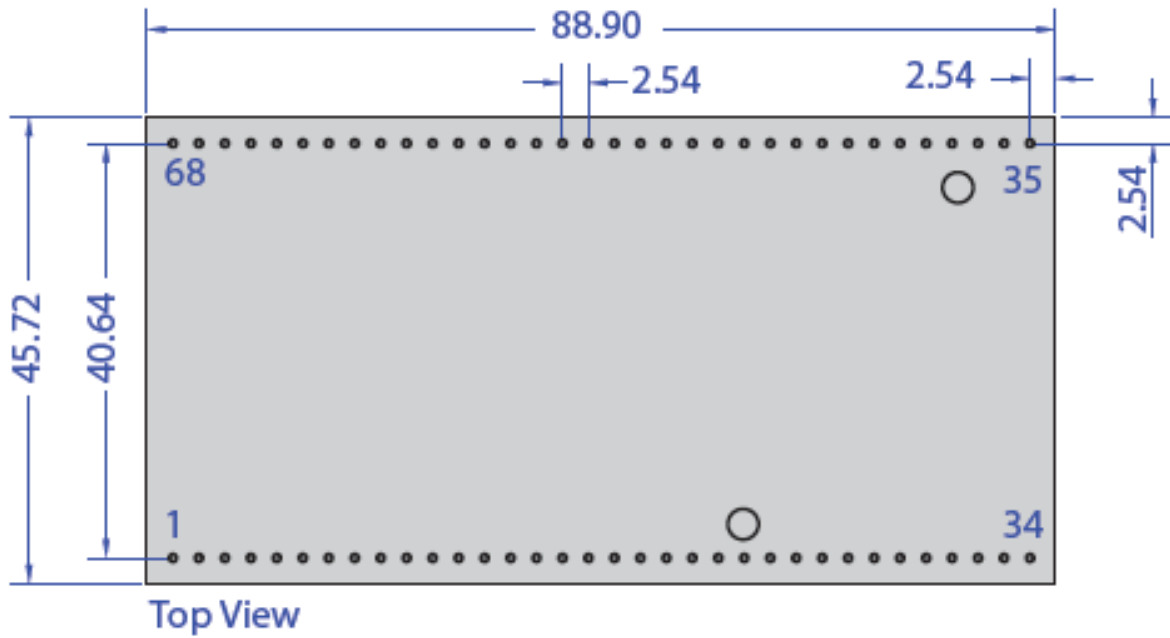

Chapter 2

Installation

2.1 Board Outline

- VDX-6300

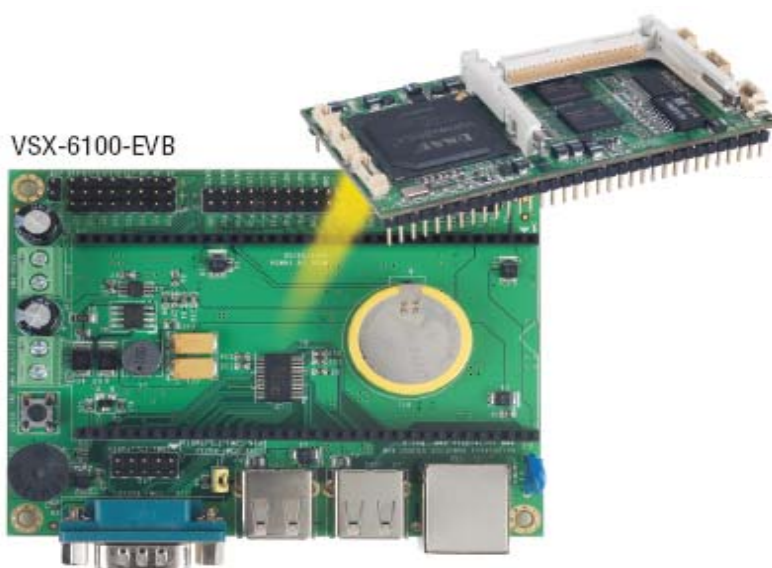
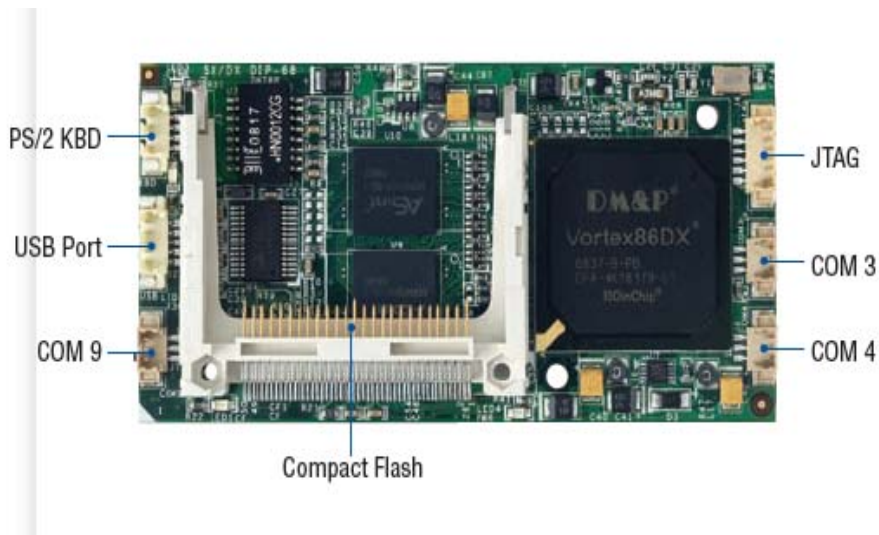

VSX-6100 Development Kit

2.2 Connectors & Jumpers Location

■ VSX-6100-EVB (Evaluation board)

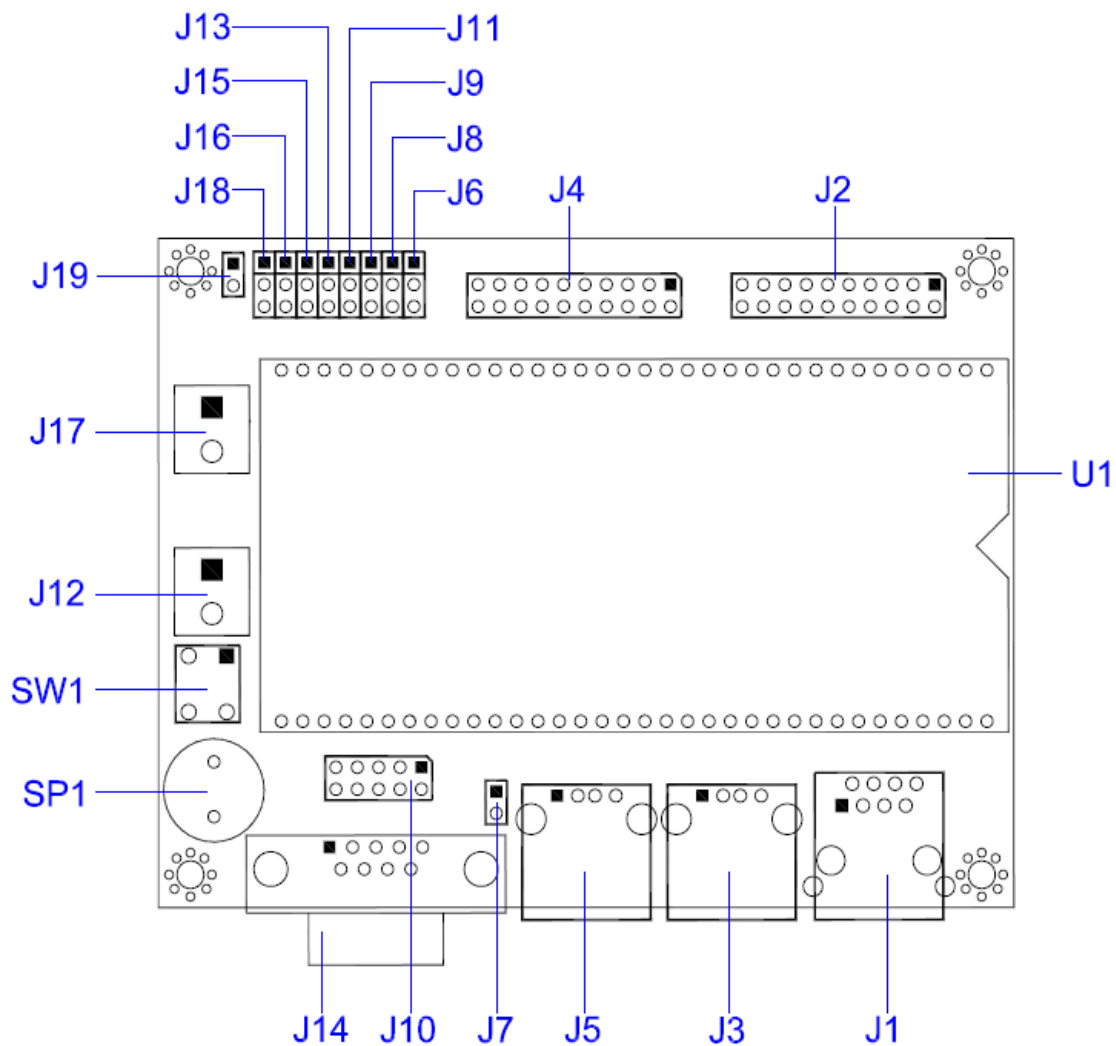

■ VDX-6300

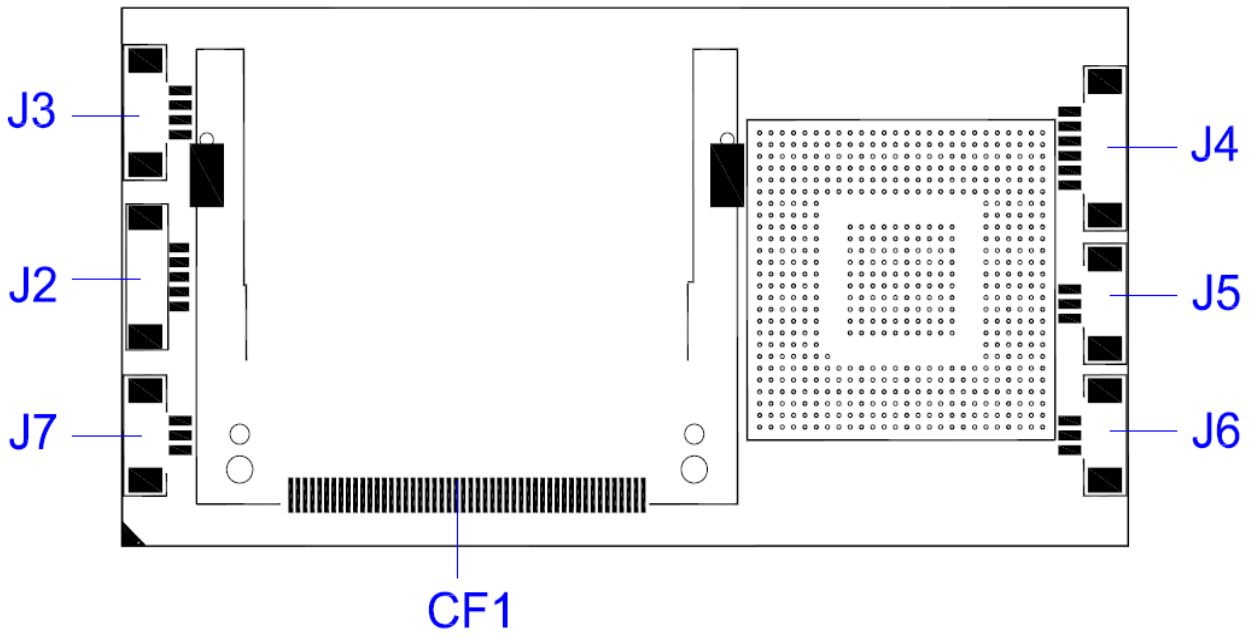

2.3 Connectors & Jumpers Summary

■ VSX-6100-EVB (Evaluation board)

Summary Table			
Nbr	Description	Type of Connections	Pin nbrs.
J1	10/100Base-T Ethernet LAN	RJ45 Connector	8-pin
J2	GPIO Port 0 / 1	Pin Header, 2.54Ø ,10x2	20-pin
J3	USB 2	USB connector	4-pin
J4	Timer Counter COM2	Pin Header, 2.54Ø ,10x2	20-pin
J5	USB 1	USB connector	4-pin
J6	SERVO1	Pin Header, 2.54Ø, 3x1	3-pin
J7	RS232 / TTL select (COM1)	Pin Header, 2,54Ø,1x2	2-pin
J8	SERVO2	Pin Header, 2.54Ø, 3x1	3-pin
J9	SERVO3	Pin Header, 2.54Ø, 3x1	3-pin
J10	COM1	Pin Header, 2.0Ø 5x2	10-pin
J11	SERVO4	Pin Header, 2.54Ø, 3x1	3-pin
J12	System Power connector (DC IN: 6V~24V)	Terminal Block 5.0Ø,2x1	2-pin
J13	SERVO5	Pin Header, 2.54Ø, 3x1	3-pin
J14	COM1	D-Sub Male	9-pin
J15	SERVO6	Pin Header, 2.54Ø, 3x1	3-pin
J16	SERVO7	Pin Header, 2.54Ø, 3x1	3-pin
J17	SERVO Power connector	Terminal Block 5.0Ø,2x1	2-pin
J18	SERVO8	Pin Header, 2.54Ø, 3x1	3-pin
J19	IRQ6 select	Pin Header, 2,54Ø,1x2	2-pin
U1	DIP-68 Connector	Box Header, 2.54Ø 34x2	68-pin
SW1	RESET SWITCH		
SP1	BUZZER		

■ **VDX-6300**

Summary Table

Nbr	Description	Type of Connections	Pin nbrs.
J2	USB	Wafer, 1.25Ø , 5x1	5-pin
J3	PS/2 Keyboard	Wafer, 1.25Ø , 5x1	4-pin
J4	JTAG	Wafer, 1.25Ø , 6x1	6-pin
J5	COM3	Wafer, 1.25Ø , 3x1	3-pin
J6	COM4	Wafer, 1.25Ø , 3x1	3-pin
J8	Console Redirection	Slide Switch	3-pin
J9	COM9	Wafer, 1.25Ø , 3x1	3-pin
U5	DIP-68 Connector	Pin Header, 2.54Ø 34x2	68-pin
CF1	Compact Flash	Type I/II CF Connector	50-pin
PWR-LED	Power Active LED (Red)	LED-SMD	
IDE- LED	IDE Active LED (Green)	LED-SMD	
LED 3	LAN Link/Active LED (Green)	LED-SMD	
LED 4	LAN Duplex LED (Yellow)	LED-SMD	

2.4 Pin Assignments & Jumper Settings

A: Pin Assignments & Jumper Settings of VSX-6100-EVB

J2: GPIO (Port 0 / Port 1)

Pin #	Signal Name	Pin #	Signal Name
1	GND	2	VCC
3	GP00	4	GP10
5	GP01	6	GP11
7	GP02	8	GP12
9	GP03	10	GP13
11	GP04	12	GP14
13	GP05	14	GP15
15	GP06	16	GP16
17	GP07	18	GP17
19	VCC	20	GND

J4: Timer Counter (COM2)

Pin #	Signal Name	Pin #	Signal Name
1	GND	2	VCC
3	OUT0	4	GP30
5	OUT1	6	GP31
7	OUT2	8	GP32
9	CLK0	10	GP33
11	CLK1	12	GP34
13	CLK2	14	GP35
15	GATE0	16	GP36
17	GATE1	18	GP37
19	GATE2	20	GND

J6: SERVO1

Pin #	Signal Name
1	GND
2	VDD
3	P20

J7:RS232 / TTL select (COM1)

Pin #	Signal Name
OPEN	COM1 RS232
CLOSE	COM1 TTL / Port4

J8: SERVO2

Pin #	Signal Name
1	GND
2	VDD
3	P21

J9: SERVO3

Pin #	Signal Name
1	GND
2	VDD
3	P22

J10: COM 1

Pin #	Signal Name	Pin #	Signal Name
1	DCD1	2	RXD1
3	TXD1	4	DTR1
5	GND	6	DSR1
7	RTS1	8	CTS1
9	RI1	10	GND
11	GND		

J11: SERVO4

Pin #	Signal Name
1	GND
2	VDD
3	P23

J12: System Power Connector (Terminal Block 5.0mm)

Pin #	Signal Name
1	DC IN : 6V~24V
2	GND

J13: SERVO5

Pin #	Signal Name
1	GND
2	VDD
3	P24

J15: SERVO6

Pin #	Signal Name
1	GND
2	VDD
3	P25

J16: SERV07

Pin #	Signal Name
1	GND
2	VDD
3	P26

J17: SERVO Power Connector (Terminal Block 5.0mm)

Pin #	Signal Name
1	VDD
2	GND

J18: SERV08

Pin #	Signal Name
1	GND
2	VDD
3	P27

J19: IRQ6 selection

Pin #	Signal Name
1	GND
2	IRQ6

U1: DIP-68 Connector – 68pin

Pin #	Signal Name	Pin #	Signal Name
1	GND	35	GND
2	PWRGND	36	TXDEN2
3	GP00/PWM0	37	CTS2\
4	GP01/PWM1	38	DSR2\
5	GP02/PWM2	39	DTR2\
6	GP03/PWM3	40	RXD2\
7	GP04/PWM4	41	RI2
8	GP05/PWM5	42	RTS2
9	GP06/PWM6	43	TXD2
10	GP07/PWM7	44	DCD2\
11	SPICS/ GP30	45	GND
12	SPICLIK/ GP31	46	GP23/PWM19
13	SPIDO / GP32	47	GP24/PWM20
14	SPIDI / GP33	48	GP25/PWM21
15	GP34	49	GP26/PWM22
16	GP35	50	GP27/PWM23
17	GP36	51	CTS1 / GP47
18	GP37	52	DSR1 / GP46
19	SPEAKER	53	DTR1 / GP45
20	GP20/PWM16	54	RXD1 / GP44
21	GP21/PWM17	55	RI1 / GP43
22	GP22/PWM18	56	RTS1 / GP42
23	VBATT	57	TXD1 / GP41
24	VCC	58	DCD1 / GP40
25	GP10/PWM8	59	GND
26	GP11/PWM9	60	LUSBD0-
27	GP12/PWM10	61	LUSBD0+
28	GP13/PWM11	62	LUSBD1-
29	GP14/PWM12	63	LUSBD1+
30	GP15/PWM13	64	LAN-RX-
31	GP16/PWM14	65	LAN-RX+
32	GP17/PWM15	66	LAN-TX-
33	SYSCLK	67	LAN-TX+
34	IRQ6	68	VCC

Note:

1-Multi-function pins of U1 are controlled by BIOS setting.

2- If you Enable 4M SPI flash Disk on the BIOS setting, you cannot use GP30~GP33 Pins.

B: Pin Assignments & Jumper Settings of VDX-6300

J2: USB

Pin #	Signal Name	Pin #	Signal Name
1	VCC	2	LUSBD0-
3	LUSBD0+	4	GND
5	GND		

J3: PS/2 Keyboard

Pin #	Signal Name	Pin #	Signal Name
1	KBCLK	2	KBDAT
3	GND	4	VCC

J4: JTAG

Pin #	Signal Name	Pin #	Signal Name
1	VCC	2	GND
3	TCK	4	TDO
5	TDI	6	TMS

J5: COM3

Pin #	Signal Name	Pin #	Signal Name
1	TXD3	2	RXD3
3	GND		

J6: COM4

Pin #	Signal Name	Pin #	Signal Name
1	TXD4	2	RXD4
3	GND		

J7: COM9

Pin #	Signal Name	Pin #	Signal Name
1	TXD9	2	RXD9
3	GND		

J8: Slide Switch (Console Redirection)

Pin #	Signal Name	Pin #	Signal Name
1	SPCIS	2	GND
3	NC		

U5: DIP-68 Connector – 68pin

Pin #	Signal Name	Pin #	Signal Name
1	GND	35	GND
2	PWRGND	36	TXDEN2
3	GP00/PWM0	37	CTS2\
4	GP01/PWM1	38	DSR2\
5	GP02/PWM2	39	DTR2\
6	GP03/PWM3	40	RXD2\
7	GP04/PWM4	41	RI2
8	GP05/PWM5	42	RTS2
9	GP06/PWM6	43	TXD2
10	GP07/PWM7	44	DCD2\
11	SPICS/ GP30	45	GND
12	SPICLIK/ GP31	46	GP23/PWM19
13	SPIDO / GP32	47	GP24/PWM20
14	SPIDI / GP33	48	GP25/PWM21
15	GP34	49	GP26/PWM22
16	GP35	50	GP27/PWM23
17	GP36	51	CTS1 / GP47
18	GP37	52	DSR1 / GP46
19	SPEAKER	53	DTR1 / GP45
20	GP20/PWM16	54	RXD1 / GP44
21	GP21/PWM17	55	RI1 / GP43
22	GP22/PWM18	56	RTS1 / GP42
23	VBATT	57	TXD1 / GP41
24	VCC	58	DCD1 / GP40
25	GP10/PWM8	59	GND
26	GP11/PWM9	60	LUSBD0-
27	GP12/PWM10	61	LUSBD0+
28	GP13/PWM11	62	LUSBD1-
29	GP14/PWM12	63	LUSBD1+
30	GP15/PWM13	64	LAN-RX-
31	GP16/PWM14	65	LAN-RX+
32	GP17/PWM15	66	LAN-TX-
33	SYSCLK	67	LAN-TX+
34	IRQ6	68	VCC

Note:

- 1-Multi-function pins of U5 are controlled by BIOS setting.
- 2- If you Enable 4M SPI flash Disk on the BIOS setting, you cannot use GP30~GP33 Pins.

2.5 System Mapping

System Mapping

Memory Mapping

Address	Description	Usage
0000:0000-9000:FFFF	System RAM	*
A000:0000-A000:FFFF	EGA/VGA Video Memory	
B000:0000-B000:7FFF	MDA RAM, Hercules graphics display RAM	
B000:8000-B000:FFFF	CGA display RAM	
C000:0000-C000:7FFF	EGA/VGA BIOS ROM	
C000:8000-C000:FFFF	Boot ROM enable.	*
D000:0000-D000:FFFF	Expansion ROM space.	
E000:0000-E000:FFFF	USB Legacy SCSI ROM space.	*
F000:0000-F000:FFFF	Motherboard BIOS	*

I/O Mapping

I/O Address	Owner	Usage
0000h - 000Fh	DMA 8237-1	*
0010h - 0017h	COM 9	*
0018h - 001Fh	Empty	
0020h - 0021h	PIC 8259-1	*
0022h - 0023h	6117D configuration port	*
0024h - 002Dh	Empty	
002Eh - 002Fh	Forward to LPC BUS	*
0030h - 003Fh	Empty	
0040h - 0043h	Timer counter 8254	*
0044h - 0047h	Empty	
0048h - 004Bh	PWM counter 8254	*
004Ch - 004Dh	Empty	
004Eh - 004Fh	Forward to LPC BUS	*
0050h - 005Fh	Empty	
0060h	Keyboard data port	*
0061h	Port B + NMI control port	*
0062h - 0063h	8051 download 4K address counter	*
0064h	Keyboard status port	*
0065h	WatchDog0 reload counter	*

0066h	8051 download 8bit data port	*
0067h	WatchDog1 reload counter	*
0068h - 006Dh	WatchDog1 control register	*
006Eh - 006Fh	Empty	
0070h - 0071h	CMOS RAM port	*
0072h - 0075h	MTBF counter	*
0076h - 0077h	Empty	
0078h - 007Ch	GPIO port 0,1,2,3,4 default setup	*
007Dh - 007Fh	Empty	
0080h - 008Fh	DMA page register	*
0090h - 0091h	Empty	
0092h	System control register	*
0093h - 0097h	Empty	
0098h - 009Ch	GPIO direction control	*
00A0h - 00A1h	PIC 8259-2	*
00A2h - 00BFh	Empty	
00C0h - 00DFh	DMA 8237-2	*
00E0h - 00FFh	Empty	
0100h - 0101h	GPCS1 default setting address	*
0170h - 0177h	IDE1 (IRQ 15)	
01F0h - 01F7h	IDE0 (IRQ 14)	*
0220h - 0227h	COM8 Forward to LPC BUS	
0228h - 022Fh	COM7 Forward to LPC BUS	
0238h - 023Fh	COM6 Forward to LPC BUS	
0278h - 027Fh	Printer port (IRQ 7, DMA 0)	
02E8h - 02EFh	COM4 (IRQ 11)	*
02F8h - 02FFh	COM2 (IRQ 3)	
0338h - 033Fh	COM5 Forward to LPC BUS	
0376h	IDE1 ATAPI device control write only register	*
03E8h - 03Efh	COM3 (IRQ 10)	*
03F0h - 03F7h	Floppy Disk (IRQ 6, DMA 2)	
03F6h	IDE0 ATAPI device control write only register	*
03F8h - 03FFh	COM1 (IRQ 4)	*
0480h - 048Fh	DMA High page register	*
0490h - 0499h	Instruction counter register	*
04D0h - 04D1h	8259 Edge,/ level control register	*
0CF8h - 0CFFh	PCI configuration port	*
D400h - D4FFh	on board LAN	*
FC00h - FC05h	SPI Flash BIOS control register	*
FC08h - FC0Dh	External SPI BUS control register (output pin configurable GPIO3[0-3])	*

IRQ Mapping		
IRQ#	Description	Usage
IRQ0	System Timer	*
IRQ1	Keyboard Controller	*
IRQ2	Cascade for IRQ8 - 15	
IRQ3	Unassigned	
IRQ4	Serial Port 1	*
IRQ5	USB / Ethernet 10/100M LAN	*
IRQ6	USB	*
IRQ7	Unassigned	
IRQ8	Real Time Clock	*
IRQ9	Serial Port 9	*
IRQ10	Serial Port 3	*
IRQ11	Serial Port 4	*
IRQ12	Unassigned	
IRQ13	Math Coprocessor	*
IRQ14	Hard Disk Controller#1	*
IRQ15	USB	*

DMA Mapping		
DMA#	Description	Usage
DMA0		
DMA1		
DMA2	Floppy Disk Controller	
DMA3		
DMA5		
DMA6		
DMA7		

2.6 Watchdog Timer

There are two watchdog timers in Vortex86SX/DX CPU. One is compatible with M6117D watchdog timer and the other is new. The M6117D compatible watchdog timer is called WDT0 and new one is called WDT1.

We also provide DOS, Linux and WinCE example for your reference. For more technical support, please visit: <http://www.dmp.com.tw/tech> or download the PDF file:

<http://www.dmp.com.tw/tech/vortex86dx/>

2.7 GPIO (General Purpose Input / Output)

40 GPIO pins are provided by the Vortex86SX/DX for general usage in the system. All GPIO pins are independent and can be configured as inputs or outputs, with or without pull-up/pull-down resistors.

We also offer DOS, Linux and WinCE example for your reference. For more technical support, please visit: <http://www.dmp.com.tw/tech> or download the PDF file: <http://www.dmp.com.tw/tech/vortex86dx/>

2.8 SPI flash (Serial Peripheral Interface)

As SPI Flash (Serial Peripheral Interface) offers many benefits including: reduced controller pin count, smaller and simpler PCBs, reduced switching noise, less power consumption, and lower system cost

Many of users may consider using a formatted SPI flash to boot for the system or emulate SPI flash as Floppy (A: Driver or B: Driver). Then you must know how to set for this condition in CMOS Setup and boot up under DOS 6.22, X-DOS, DR-DOS and Free DOS.

For more technical support, please visit: <http://www.dmp.com.tw/tech> or download the PDF file: <http://www.dmp.com.tw/tech/vortex86dx/>

2.9 PWM (Pulse-width modulation)

Pulse-width modulation (PWM) of a signal or power source involves the modulation of its duty cycle, to either convey information over a communications channel or control the amount of power sent to a load.

The popular applications of pulse width modulation are in speed control of electric motors, volume control of Class D audio amplifiers or brightness control of light sources and many other power electronics applications.

The Vortex86DX SoC integrated 32 channels of PWM interface enabling the Automation, robotic industry to a New Age x86 SoC platform and we also offer the sample code of PWM which will guide the engineer to control the PWM functionality smoothly.

For more inquire of this sample code that please contact our sales team or mail to:

info@icop.com.tw

Chapter 3

Driver Installation

LAN

The Vortex86DX processor also integrated 10/100Mbps Ethernet controller that supports both 10/100BASE-T and allows direct connection to your 10/100Mbps Ethernet based Local Area Network for full interaction with local servers, wide area networks such as the Internet.

I/O and IRQ settings can be done by software with the supplied utility software, or it can be set for Plug and Play compatibility. The controller supports: Half / Full-Duplex Ethernet function to double channel bandwidth, auto media detection.

Operating system support

The Vortex86DX-6300 DIP 68pin CPU module provides the VGA and LAN drivers for DOS 6.22 Windows CE 5.0, CE 6.0, Windows 98, Windows XP Professional, Windows Embedded standard (XPE) and Windows 2000.

Please get the drivers from the Driver CD which attached with the standard packing of Vortex86DX-6300 CPU module or please get it from DMP official website:

<http://www.dmp.com.tw/tech/vortex86dx/>

Vortex86DX-6300 also supports most of the popular Linux distributions, for more detail information, please visit DMP official website: <http://www.dmp.com.tw/tech/vortex86dx/>

Appendix

A. TCP/IP library for DOS real mode

DSock is a TCP/IP library for DOS real mode, which is used by RSIP. It provides simple C functions for programmer to write Internet applications. ICOP also provide Internet examples using DSock: BOOTP/DHCP, FTP server, SMTP client/server, HTTP server, TELNET server, Talk client/server, etc.

DSock provides a lot of example source code. Programmer can add Internet functions to their project easily and save development time. With a utility "MakeROM", programmer also can make a ROM image to fit their application, those examples can be seen in the following Application systems: Mity-Mite Serial Server, Web Camera Tiny Server and RSIP Serial Server.

DSock is free for All ICOP products using M6117D/Vortex86/Vortex86SX CPU and ICOP also provide the business version of DSock for those customers who are using other x86 CPUs. If you would like to use DSock or business version of DSock, Please mail to info@icop.com.tw or contact your regional sales.

Please download the trial DSock software and Utilities from our website:
<http://www.dmp.com.tw/tech/dmp-lib/dsock/>

B. BIOS Default setting

If the system cannot be booted after BIOS changes are made, Please follow below procedures in order to restore the CMOS as default setting.

- Press “End” Key, when the power on



- Press to enter the AMI BIOS setup
- Press “F9” to Load Optimized Defaults
- Press “F10” to Save configuration changes and exit setup

C. Console Redirection setting

■ Hardware requirement:

1. VDX-6300 & VSX-6100-EVB (Evaluation board)
2. Any PC with COM port, which installed Windows XP (or other Windows OS) with Hyper Terminal
3. A D-Sub 9 pin Female to Female Cable.

■ Enable the Console Redirection by hardware switch of VDX-6300.

1. Enable the "Console Redirection" by hardware switch (Figure 1).
2. Make sure J7 as "CLOSE" (Figure 2).
3. Use A D-Sub 9 pin Female to Female Cable to connect to COM1 and your PC's Serial Port.

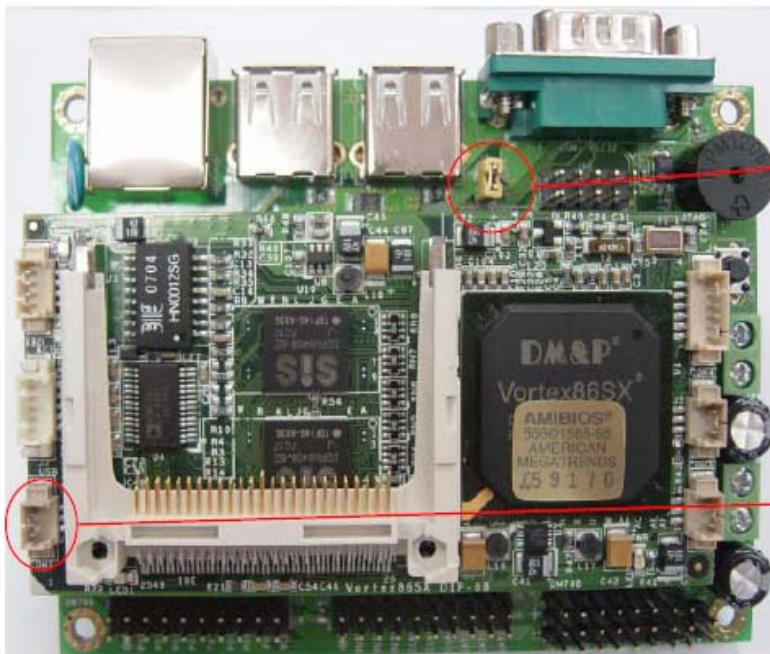

(Figure 2)



(Figure 1)

● Setup the Hyper Terminal under Windows XP

Run Hyper Terminal

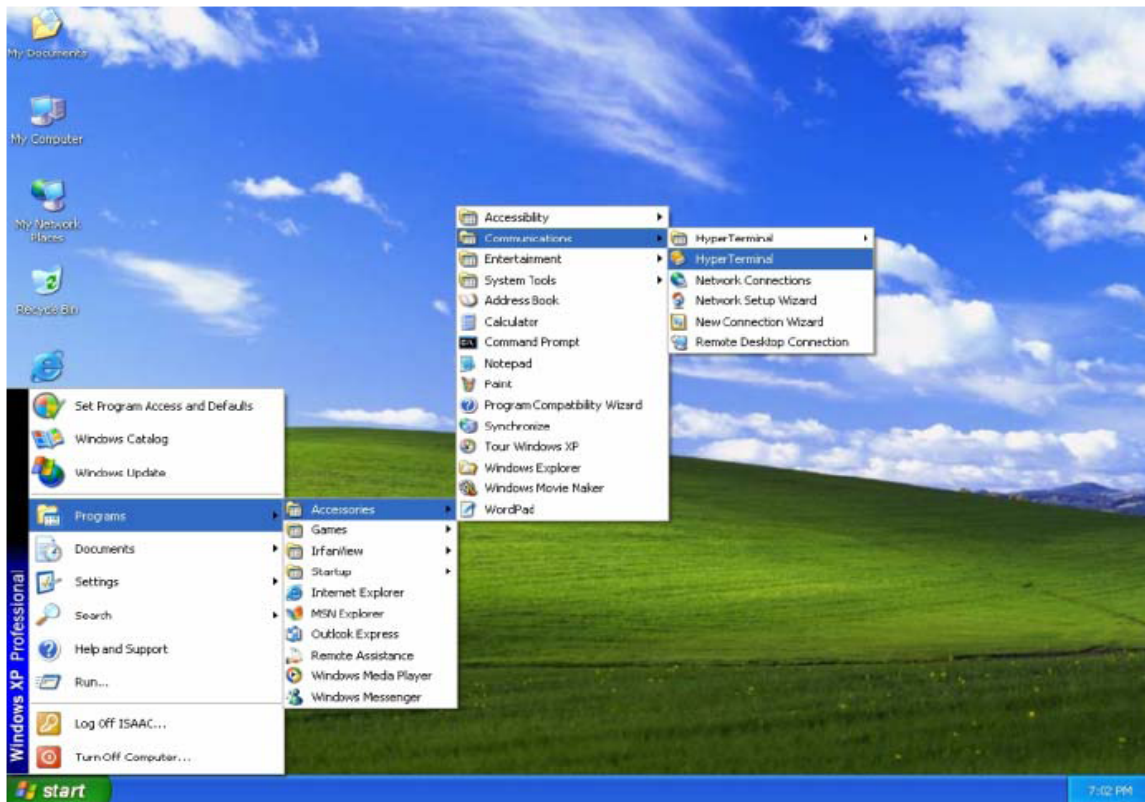

Build up a new connection

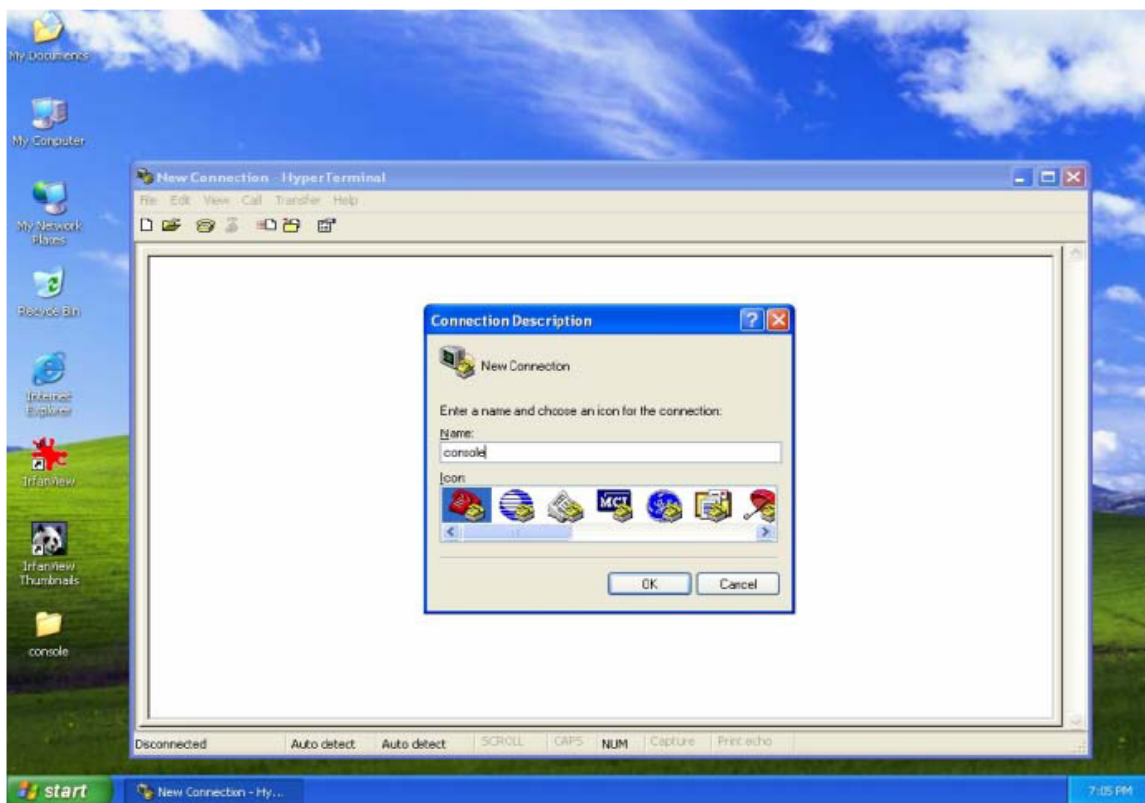

Select the right COM port (PC side)

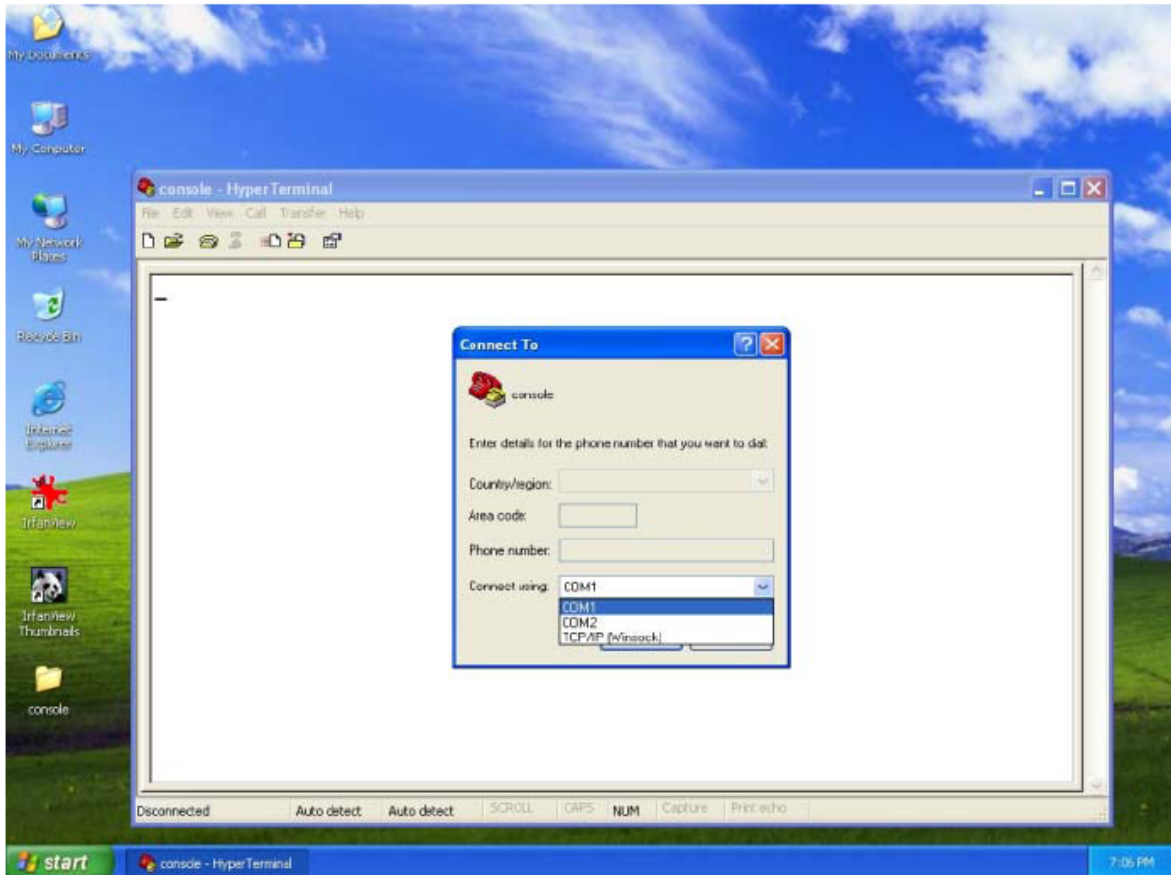

Set the port setting as “115200, 8, None, 1, None”, which are the same setting as VDX-6300 BIOS.

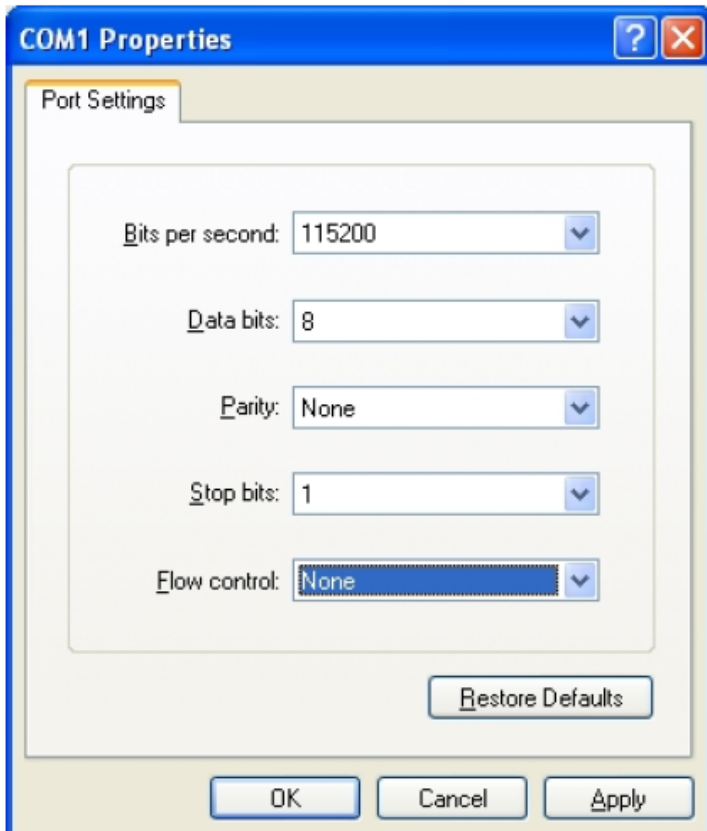

Restart the VDX-6300 and you will see the boot up screen from Hyper Terminal of your PC.

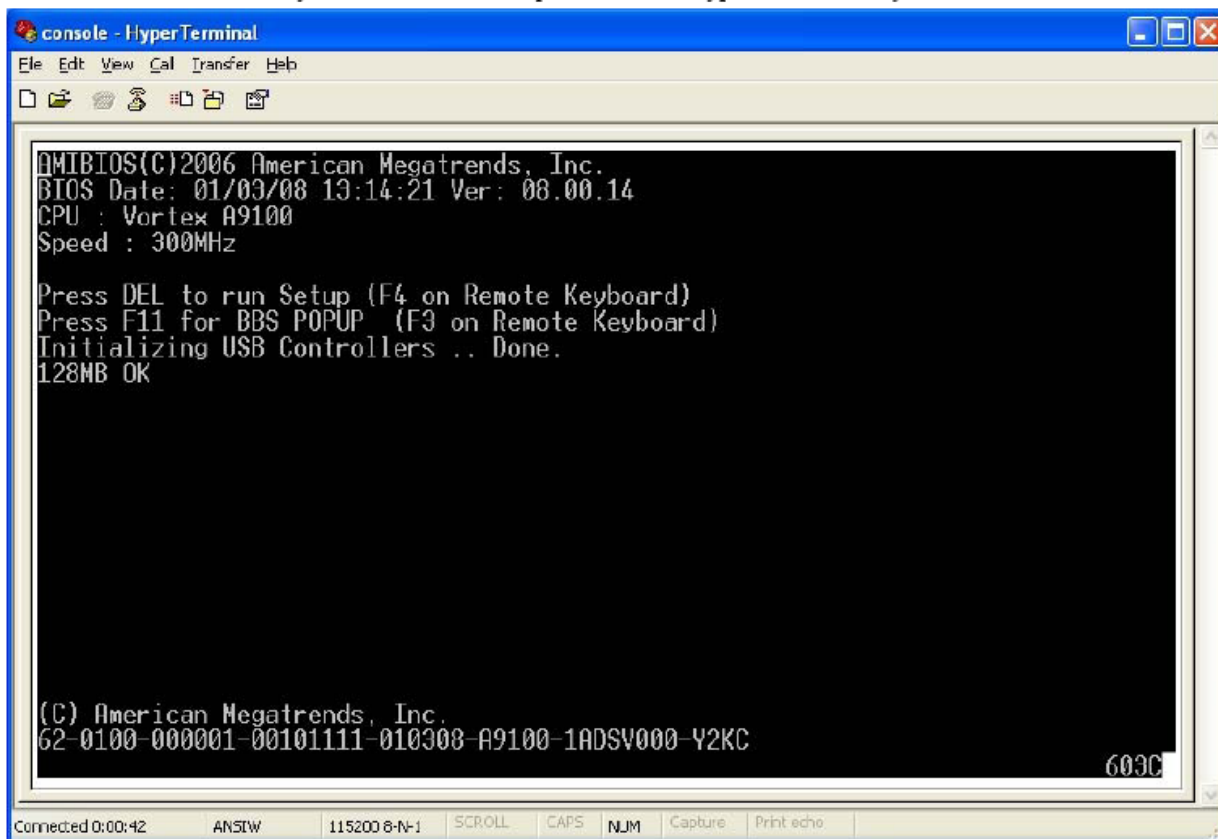

You can press the “F4” key on your Keyboard in order to enter the BIOS setting of VDX-6300.

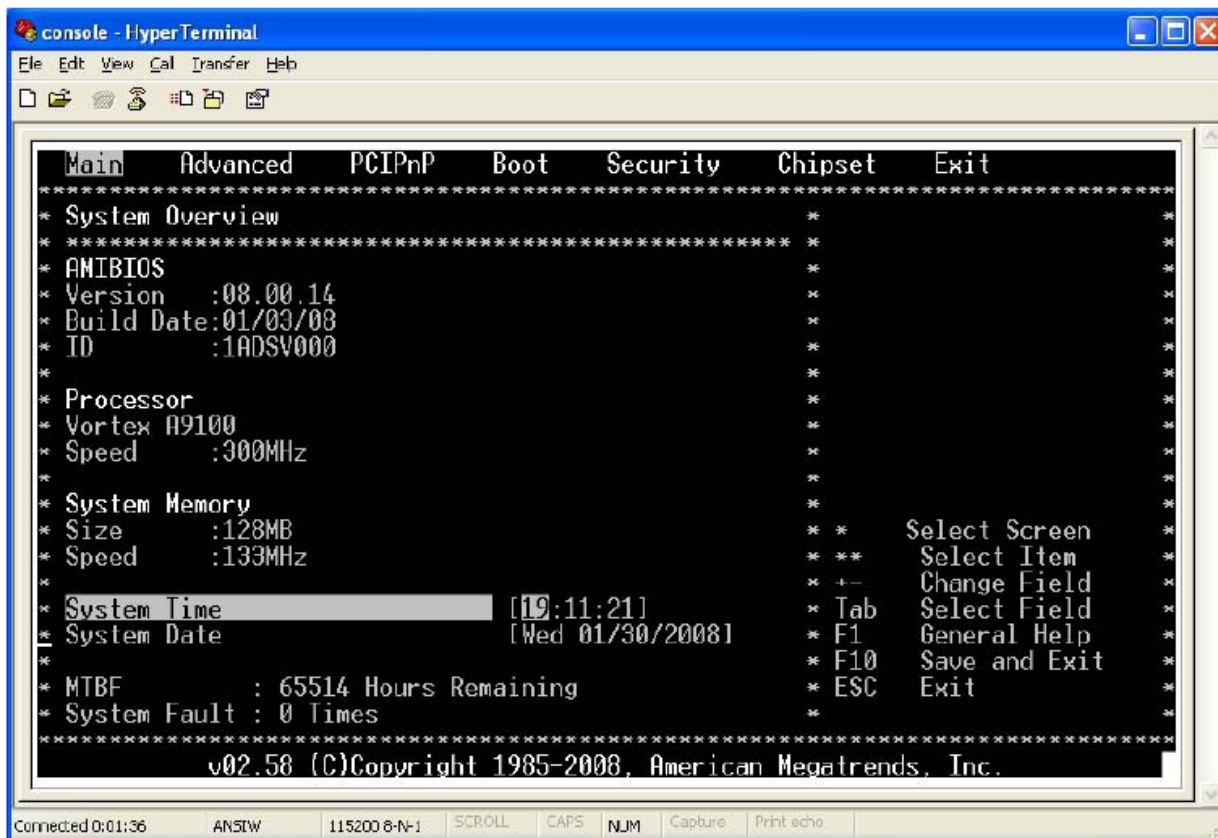

Or you can press "F3" key to select the boot device.

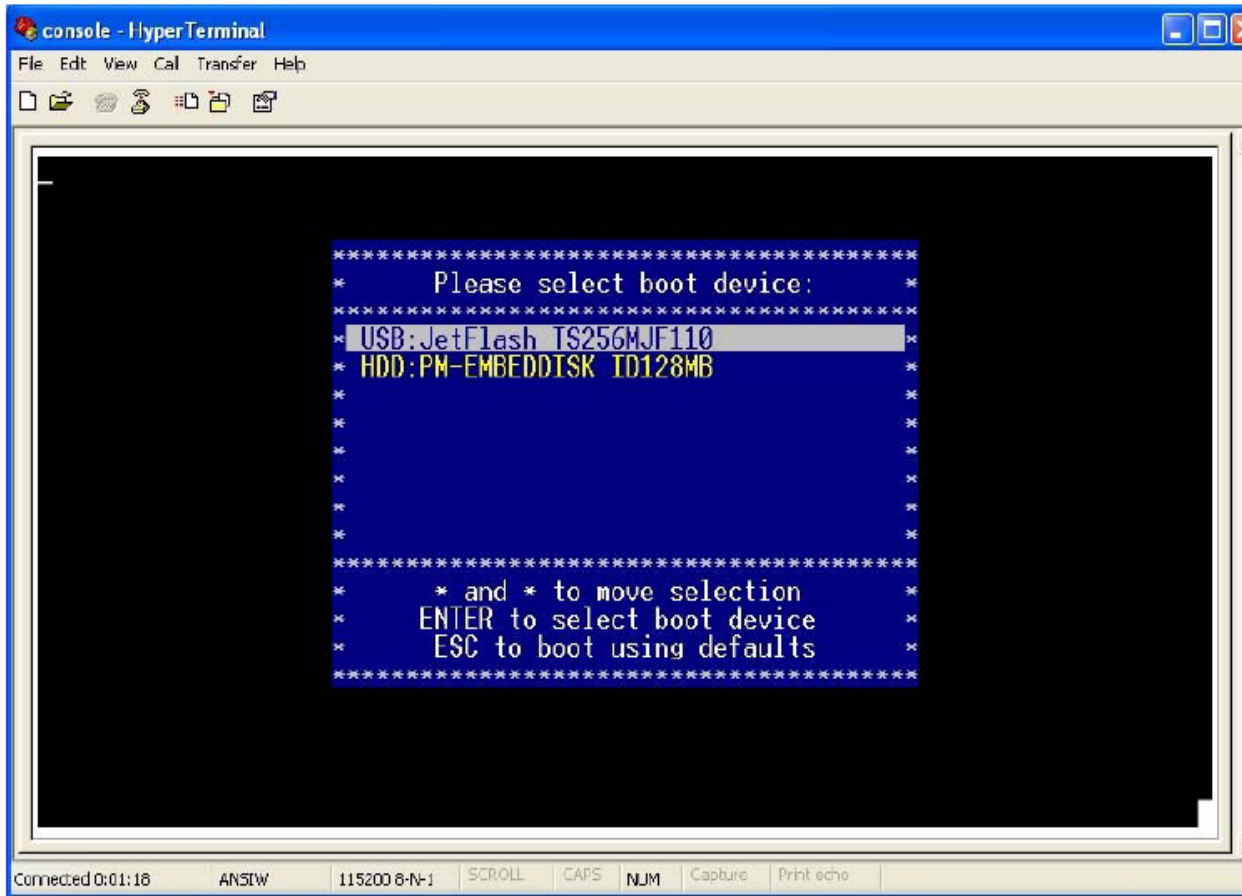

D. VSX-6100-EVB (Evaluation board) Schematic

Schematic information can help baseboard designer to optimize exactly how each of these functions implements physically. Designer can place connectors precisely where needed for the application on a baseboard designed to optimally fit a system's packaging.

Please contact or e-mail our regional sales to get VSX-6100-EVB (Evaluation board) Schematic.

Warranty

This product is warranted to be in good working order for a period of one year from the date of purchase. Should this product fail to be in good working order at any time during this period, we will, at our option, replace or repair it at no additional charge except as set forth in the following terms. This warranty does not apply to products damaged by misuse, modifications, accident or disaster. Vendor assumes no liability for any damages, lost profits, lost savings or any other incidental or consequential damage resulting from the use, misuse of, originality to use this product. Vendor will not be liable for any claim made by any other related party. Return authorization must be obtained from the vendor before returned merchandise will be accepted. Authorization can be obtained by calling or faxing the vendor and requesting a Return Merchandise Authorization (RMA) number. Returned goods should always be accompanied by a clear problem description.