



ICOP-6042VE

Embedded Vortex86™ Half-Size AIO SBC

w/2S/CRT/LCD/Ethernet

User's Manual

(Revision 1.0)

● **Copyright**

The information in this manual is subject to change without notice for continuous improvement in the product. All rights are reserved. The manufacturer assumes no responsibility for any inaccuracies that may be contained in this document. And makes no commitment to update or to keep current the information contained in this manual.

No part of this manual may be reproduced, copied, translated or transmitted, in whole or in part, in any form or by any means without the prior written permission of the ICOP Technology Inc..

©Copyright 2002 ICOP Technology Inc.
Manual No. ITQG6042000-01 ● June 27, 2002

● **Trademarks Acknowledgment**

Vortex86™ is the registered trademark of ICOP Technology Inc.

Other brand names or product names appearing in this document are the properties and registered trademarks of their respective owners. All names mentioned herewith are served for identification purpose only.

Table of Contents

Table of Contents	iii
Chapter 0	Startup
0.1 Packing List	1
0.2 Specifications	2
Chapter 1	Introduction
1.1 Features	3
1.2 Specifications	4
1.3 VGA Interface	5
1.4 DiskOnChip 2000 Flash Disk	6
1.5 Network Interface	6
Chapter 2	Installation
2.1 Board Outline	7
2.2 Connectors & Jumpers Location	8
2.3 Connectors & Jumpers Summary	9
2.4 Pin Assignments & Jumper Settings.....	10
J1 : VGA Connector.....	10
J2 : GPIO.....	10
J3 : PRT/CIR.....	10
J4 : Frequency Selection	11
J5 : Power Good	11
J6 : USB Connection	12
J7 : Power Button	12
J8 : PS/2 Keyboard Connection.....	12
J9 : PS/2 Mouse Connection	12
J10 : LCD Volts Sel.....	13
J11 : LCD Connection.....	13
J12 : PS/2 Keyboard & Mouse Connector	14
J13 : 10/100Base-T Ethernet LAN	14
J14 : IDE LED	15

J15 : IDE Connection	15
ROM1: DOC Connector.....	16
J16 : Power Mode Sel.	16
J17 : Power Connector	17
J18 : Power Header	17
J19 : RS232/485 Select	17
J20 : RS485	17
J21 : FDD Connection.....	18
J22 : COM1 Connector	18
J23 : COM1 Connection.....	19
J24 : COM2 Connection.....	19
J25 : Printer Connection.....	19
J26 : ISA Bus SL36 Pin.....	20
J27 : ISA Bus SL62 Pin.....	21
J28 : PC/104 Connector CN1	22
J29 : PC/104 Connector CN2	23
2.5 DiskOnChip/Flash ROM Disk.....	24
2.2.1 Setup a DiskOnChip ® 2000 Flash Disk.....	24
2.6 Watchdog Timer.....	26
Chapter 3 SVGA Setup	
3.1 Introduction	32
3.1.1 Chipset.....	31
3.1.2 Display memory.....	31
3.2 Flat Panel BIOS and Wiring.....	33
Chapter 4 Network Interface	
4.1 Introduction	41
4.2 Software Support	41
Warranty.....	42

Chapter 0

Startup

0.1 Packing List

Product Name	Function	Package
ICOP-6042VE	Embedded Vortex86™ (SiS) Half-size All-in-One SBC	<ul style="list-style-type: none">● ICOP-6042VE Embedded Vortex86 Half-size All-in-One SBC● Manual & Drivers CD x 1● FDD cable x 1● HDD cable x 1● RS232 cable x 2● I/O Bracket for Printer port x 1● PS2 Y-cable for Keyboard and Mouse x 1

0.2 Specifications

Features	ICOP-6042VE
Processor Chipset	DM&P(SiS) Vortex86™ System-on-Chip CPU-166MHz
Bus Interface	Half size ISA Bus
Memory	168-pin DIMM Socket, support up to 512MB
BIOS	AMI BIOS
Multi I/O Chip	<ul style="list-style-type: none"> ● Enhanced IDE interface ● RS232 port x1 ● RS232/485 port x1 ● Parallel port x1 ● FDD interface x1 ● USB port x2 (optional)
Video Display	<ul style="list-style-type: none"> ● AGP Rev.2.0 Compliant ● Shared system memory area up to 128MB. ● Resolution up to 1,920Cx1,440 true colors ● CRT/LCD display ● External 15-pin D-type female VGA connector ● 44-pin box header for LCD connector
LAN	<ul style="list-style-type: none"> ● Realtek 8100B single chip ● Full-duplex transfer mode, doubles effective bandwidth 16KB RAM buffer ● NE2000 compatible with built-in 16KB RAM buffer ● Throughput 10/100Mbps
Watchdog Timer	<ul style="list-style-type: none"> ● Software Watchdog Timer ● Three 8254 Compatible Programmable 16-bit Counters. ● From 30.5μs to 512 seconds
DiskOnChip	One socket for DiskOnChip 8MB~256MB
Connectors	<ul style="list-style-type: none"> ● External 15-pin D-type female VGA connectpr ● One 26-pin box header for parallel port ● One 34-pin box header for floppy disk drive ● One 44-pin box header for LCD connector ● One 32-pin socket for for DiskOnChip ● One RJ-45 connector for 10/100Base-T
Power Requirement	<p>Single Voltage +5V @1.3 A</p> <p>Single Voltage +5V with ACPI function (Advanced Configuration and Power Interface)</p>
Board Weight	225g
Board Size	184mm X 122mm
Operating Temperature	-20°C ~ +60°C

Chapter 1

Introduction

1.1 Features

- Embedded Half-size ISA Bus Single Board Computer (184 x122 mm)
- DM&P Vortex86™ System-On-Chip
- CRT and Flat Panel Display interface
- 168-pin DIMM Socket x1 for Memory expansion up to 512MB
- Enhanced IDE devices and FDD interface
- One Bi-directional Parallel Port
- RS-232/485 interface
- Watchdog timer
- Socket for DiskOnChip
- Onboard Keyboard & Mouse connector
- Onboard Ethernet, compatible with NE2000
- Single voltage +5 V power connector
- Operating temperature from -20°C • +60°C
- Board Support Package for Windows CE.NET and Windows XP Embedded
- Flexible OEM/ODM design

1.2 Specifications

- **Embedded CPU:** DM&P Vortex86™ System-on-Chip CPU – 166MHz, Realtime clock, and watchdog timer.
- **BIOS:** Y2K compliant AMI system BIOS
- **DRAM Memory:** Support up to 512MB DIMM PC133
- **Bus Interface:** ISA Bus
- **Data Bus:** 16-bit
- **Bus Speeds:** PCI Bus – 33MHz
- **DMA Channels:** 7
- **Interrupt Levels:** 15
- **Enhanced IDE:** supports one port and up to two hard drives or Enhanced IDE devices of PIO mode 4. BIOS enabled/disabled
- **Watchdog Timer:** generates either a RESET, NMI or an IRQ when your application loses control over the system. Optionally the watchdog can trigger a user specified interrupt. The watchdog is configurable from 30.5µs to 512 seconds (in 30.5µs segments)
- **Real-time Clock:** included in Vortex86 SOC with onboard lithium battery backup for 10 years of data retention. CMOS data backup of BIOS setup and BIOS default.
- **Keyboard and Mouse Connectors:** Supports PS/2 Keyboard and mouse
- **Serial ports:** Supports high speed RS-232 port, high speed RS-232/485 port (jumper selectable).
- **Floppy Disk Drive Interface:** supports up to two floppy drives, 5¼" (360 KB or 1.2 MB) and 3½" (720 KB, 1.44 MB). BIOS enabled / disabled
- **Bi-directional Parallel Port:** supports SPP, EPP and ECP mode. BIOS enabled/disabled
- **Environmental and Power**
- **Power Requirements:** single voltage +5 V @ 1.3A
- **Board Dimensions:** 184 (L) x 122 (W) mm.
- **Board Weight :** 225 g
- **Extended Operating Temperature:** -20°C ~+60 °C

1.3 VGA Interface

- **Chipset:** DM&P Vortex86™ SOC
- **Memory:** Shared system memory up to 128MB
- **System Bus:** 33-bit PCI bus
- **Panel Data Bus:** 24-bit
- **Display:** CRT and LCD Flat Panel

● **Compliance:**

- AGP 2.0 / 4X Compliant / Fully DirectX 8 Compliant
- Built-In DVI / DSTN / VIP interface
- Cooperates with "Video Bridge" to support NTSC/PAL TV / Digital LCD Monitor / Secondary CRT Monitor output

● **Digital Output:**

- Supports VESA Standard Super High Resolution Graphic Modes
- 640x480 16/256/32K/64K/16M Colors 160 Hz NI
- 800x600 16/256/32K/64K/16M Colors 120 Hz NI
- 1024x768 256/32K/64K/16M Colors 120 Hz NI
- 1280x1024 256/32K/64K/16M Colors 85 Hz NI
- 1600x1200 256/32K/64K/16M Colors 85 Hz NI
- 1920x1440 256/32K/64K Colors 60 Hz NI
 - 1920x1440 256 Colors 75 Hz NI
 -

● **Supported Flat Panels:**

- SHARP 12" DSTN LCD panel P/N : LM12S402
- SHARP 12" LCD connector P/N : HIROSE_DF9B-41P-1V
- SHARP 10" DSTN LCD panel P/N : LM100SS1T522
- SHARP 10" LCD connector P/N : JAE_FI-W31P-HF
- NEC LCD connector P/N : HIROSE DF9C-41P-1V
- PVI 6.4" LCD connector P/N : JST FLH-RSM1-30PIN
- PVI 6.4" LCD connector P/N : DF9A-31P-1V
- NAN YA 3.9" FSTN LCD panel product No. : LCBA7T211M2
- NAN YA 5.7" FSTN LCD panel, the panel P/N : LCBHB_B61_

1.4 DiskOnChip 2000 Flash Disk

Flash Disk DiskOnChip® 2000

- **Chipset:** DM&P Vortex86™ SOC
- **Package:** Single Chip FlashDisk in 32-pin DIP JEDEC
- **Capacity:** 8-256 MByte capacity
- **Data Reliability:** ECC/EDC error correction
- **Memory Window:** 8 Kbyte

1.5 Network Interface

- **Chipset:** Realtek 8100B single chip
- **Type:** 10/100BASE-T
- **Transfer Mode:** Full duplex, doubles effective bandwidth
- **Buffer:** Built-in 16KB RAM Buffer.
- **Connectors:** 8-pin male header , pitch 2.0mm
- **Monitoring LEDs:** network ready indicator, network activity indicator
- **Compatibility:** NE2000

Chapter 2

Installation

2.1 Board Outline

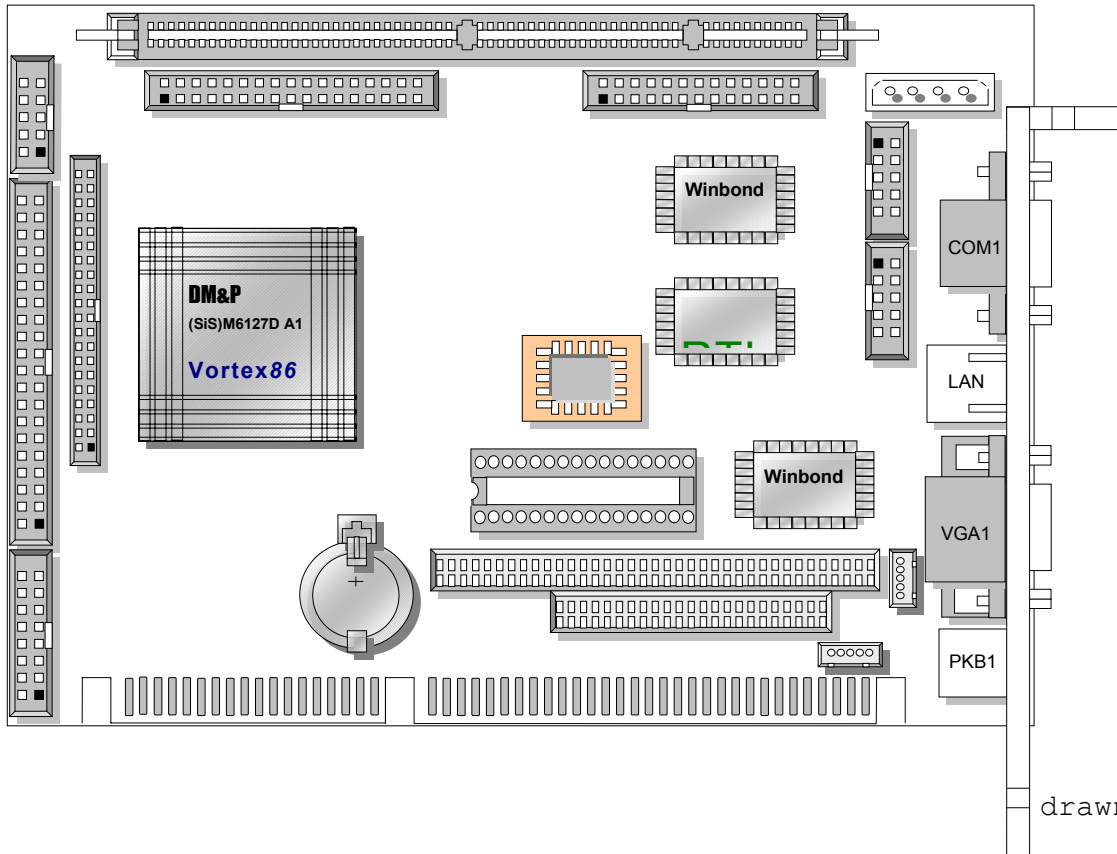

2.2 Connectors & Jumpers Location

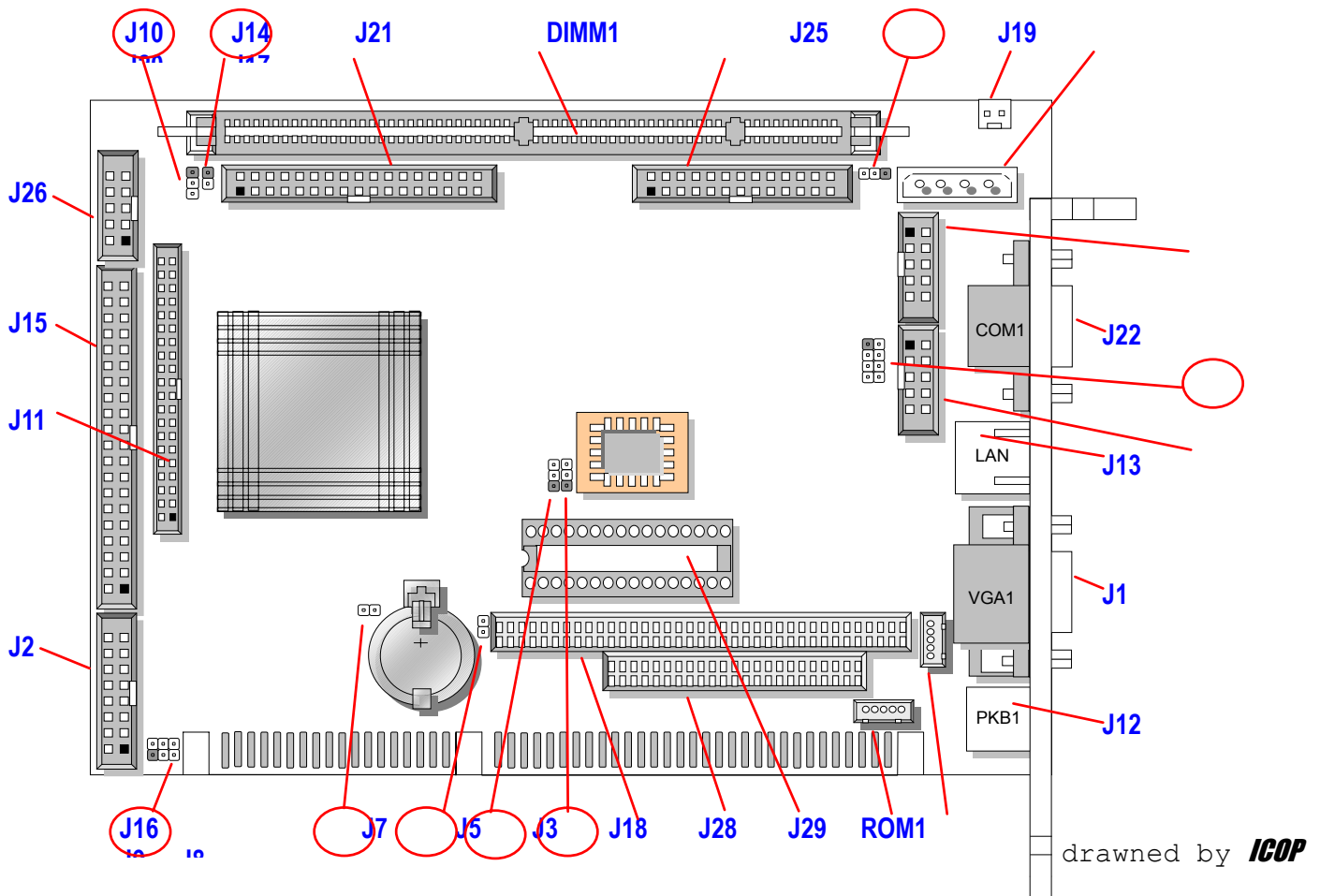

Note: The encircled indication  are for Jumpers only. Please refer to Section 2.4 for their pin assignments.

2.3 Connectors & Jumpers Summary

Summary Table

Nbr	Description	Type of Connections	Pin nbrs.
J1:	VGA Connector	D-Sub Connector	15-pin
J2:	GPIO	Box Header, 10x2	20-pin
J3:	PRT/CIR	Pin Header	3-pin
J4:	Frequency selection	Pin Header, 4x2	8-pin
J5:	Power Good	Pin Header	2-pin
J6:	USB	Box Header, 5x2	10-pin
J7:	Power Button	Pin Header	2-pin
J8:	PS/2 Keyboard	Box Header, 2.0Ø Molex	5-pin
J9:	PS/2 Mouse	Box Header, 2.0Ø Molex	5-pin
J10:	LCD Volts Sel.	Pin Header	3-pin
J11:	LCD Connector	Box Header, 2.0Ø , 22x2	44-pin
J12:	PS/2 Keyboard & Mouse	Mini-Din Connector	6-pin
J13:	10/100Base-T Ethernet LAN	RJ45 Connector	12-pin
J14:	IDE LED	Pin Header	2-pin
J15:	IDE Connector	Box Header, 20x2	40-pin
ROM1	DOC Connector (DiskOnChip)	DIP Socket, Grid hole	32-pin
J16	Power Mode Sel.	Pin Header, 3x2	6-pin
J17:	Power Connector	Box Header, 5.0Ø Molex	4-pin
J18:	Power Header	Pin Header	3-pin
J19:	RS232/RS485 Select	Pin Header	3-pin
J20:	RS485	Pin Header, 2.54Ø Molex	2-pin
J21:	FDD Connector	Box Header, 17x2	34-pin
J22	COM1	D-Sub Connector	9-pin
J23:	COM1	Box Header, 5x2	10-pin
J24:	COM2	Box Header, 5x2	10-pin
J25:	Printer Connector	Box Header, 13x2	26-pin
J26:	ISA Bus SL36	Gold Fingers, 18x2	36-pin
J27:	ISA Bus SL62	Gold Fingers, 31x2	62-pin
J28:	PC/104 Connector CN1	Socket Header, 32x2	64-pin
J29:	PC/104 Connector CN2	Socket Header, 20x2	40-pin

2.4 Pin Assignments & Jumper Settings

J1 :VGA Connector – 15-pin D-Sub Connector (female)

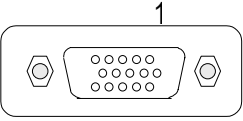
	Pin #	Signal Name	Pin #	Signal Name	Pin #	Signal Name
	1	MR	6	GND	11	NC
	2	MG	7	GND	12	VCC
	3	MB	8	GND	13	HYSYNC
	4	NC	9	NC	14	VSYNC
	5	GND	10	GND	15	VCC

J2 : GPIO - 2.54 \varnothing 20-pin Box Header

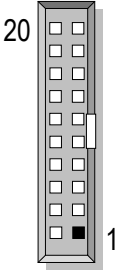
	Pin #	Signal Name	Pin #	Signal Name
	1	GND	2	VCC
	3	GPIO0	4	GPIO8
	5	GPI1	6	GPI09
	7	GPI2	8	GPI10
	9	GPI3	10	GPI11
	11	GPI4	12	NC
	13	GPI5	14	NC
	15	GPI6	16	NC
	17	GPI7	18	NC
	19	VCC	20	GND

J3: PRT/CIR - 3-pin Header

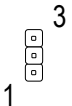
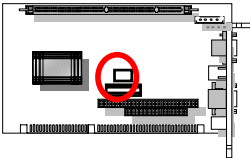
	Pin #	Signal Name	
	1	AG4	
	2	SB5V	
	3	GND	

J4 : Frequency Selection - 8-pin Header

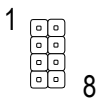

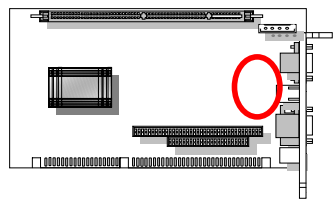

Clock Gen. Table							AGPCLK (MHz)	
FS3	FS2	FS1	FS0	CPU (MHz)	SDRAM (MHz)	PCI (MHz)	AGPSEL=0	AGPSEL=1
0	0	0	0	66.6	66.6	33.3	66.6	50
0	0	0	1	100	100	33.3	66.6	50
0	0	1	0	166	166	33.3	62.5	55.6
0	0	1	1	133	133	33.3	66.6	50
0	1	0	0	66.6	100	33.3	66.6	50
0	1	0	1	100	66.6	33.3	66.6	50
0	1	1	0	100	133	33.3	66.6	50
0	1	1	1	133	100	33.3	66.6	50
1	0	0	0	112	112	33.6	67.2	56
1	0	0	1	124	124	31	62	46.5
1	0	1	0	138	138	34.5	69	51.8
1	0	1	1	150	150	30	60	50
1	1	0	0	66.6	133	33.3	66.6	50
1	1	0	1	100	150	30	60	50
1	1	1	0	150	100	30	60	50
1	1	1	1	160	120	30	60	48

Note: PCICLK < 34.5MHz.

J5: Power Good - 2-pin Header

	Pin #	Signal Name
	1	PWROK
	2	GND

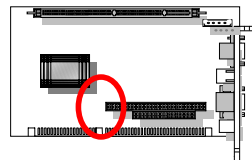

J6: USB Connector - 10-pin Box Header

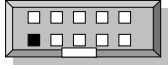
	Pin #	Signal Name	Pin #	Signal Name
	1	VCC	2	VCC
	3	-DATA1	4	-DATA0
	5	+DATA1	6	+DATA0
	7	GND	8	GND
	9	GND	10	GND

J7: Power Button - 2-pin Header

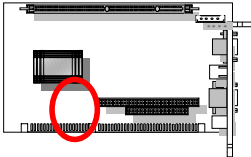
	Pin #	Signal Name	
	1	PWRBIN-	
	2	GND	

J8 : PS/2 Keyboard - 5-pin Header

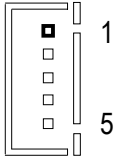
	Pin #	Signal Name
	1	KBCLK
	2	KBDAT
	3	NC
	4	GND
	5	SB 5V (VCC)

J9 : PS/2 Mouse - 5-pin Header

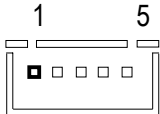
	Pin #	Signal Name
	1	PMCLK
	2	PMDAT
	3	NC
	4	GND
	5	SB 5V (VCC)

J10: LCD Volts Sel. - 3-pin Header

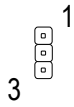
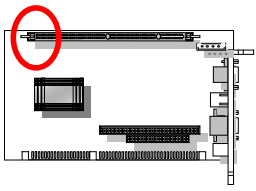
	Pin #	Signal Name	
	1	VCC	
	2	LCDVCC	
	3	VCC3	

J11: LCD Connector - 2.0 \varnothing pitch 44-pin Box Header

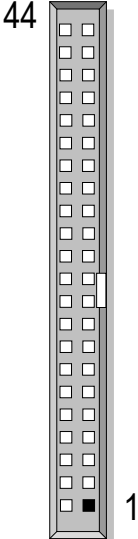
	Pin #	Signal Name	Pin #	Signal Name
	1	+12V	2	-12V
	3	GND	4	GND
	5	PVCC	6	PVCC
	7	FPVEE	8	FPVEE
	9	PD0	10	PD1
	11	PD2	12	PD3
	13	PD4	14	PD5
	15	PD6	16	PD7
	17	PD8	18	PD9
	19	PD10	20	PD11
	21	PD12	22	PD13
	23	PD14	24	PD15
	25	PD16	26	PD17
	27	PD18	28	PD19
	29	PD20	30	PD21
	31	PD22	32	PD23
	33	GND	34	GND
	35	SCLK	36	FLM
	37	M	38	LP
	39	GND	40	ENABKL
	41	GND	42	ASHFCLK
	43	VCC	44	VCC

J12 : PS/2 Keyboard & Mouse - 6-pin Mini Din Connector

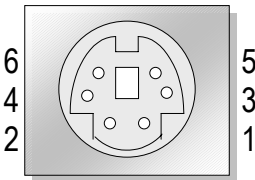
	Pin #	Signal Name
	1	KBCLK
	2	PMCLK
	3	GND
	4	KBDAT
	5	PMDAT
6	SB 5V (VCC)	

J13 : 10/100Base-T Ethernet LAN – 12-pin RJ45 Connector

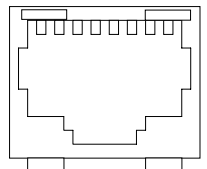
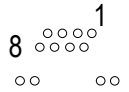
 <p>PCB Solder Side</p> 	Pin #	Signal Name	Pin #	Signal Name
	1	TD+	2	TD-
	3	R0+	4	NC
	5	NC	6	R0-
	7	NC	8	NC
	9	VCC	10	VCC
10	PLED0	12	PLED1	

J14: IDE LED - 2-pin Header

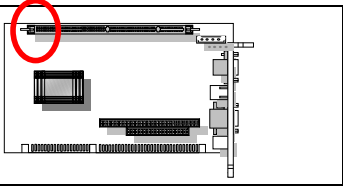
	Pin #	Signal Name	
	1	VCC	
	2	DASP	

J15: IDE Connector - 40-pin Box Header

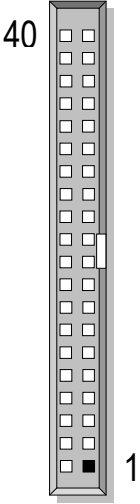
	Pin #	Signal Name	Pin #	Signal Name
	1	IDERST-	2	GND
	3	IDED7	4	IDED8
	5	IDED6	6	IDED9
	7	IDED5	8	IDED10
	9	IDED4	10	IDED11
	11	IDED3	12	IDED12
	13	IDED2	14	IDED13
	15	IDED1	16	IDED14
	17	IDED0	18	IDED15
	19	GND	20	NC
	21	IDEREQ	22	GND
	23	IDEIOW-	24	GND
	25	IDEIOR-	26	GND
	27	ICHRDY	28	GND
	29	IDACK-	30	GND
	31	IDEIRQ	32	NC
	33	IDESA1	34	CBLID
	35	IDESA0	36	IDESA2
	37	IDECS-0	38	IDECS-1
39	DASP	40	GND	

ROM1 : (DiskOnChip) DOC Connector – 32-pin Grid hole DIP Socket

Pin #	Signal Name	Pin #	Signal Name
1	NC	2	NC
3	NC	4	XA12
5	XA7	6	XA6
7	XA5	8	XA4
9	XA3	10	XA2
11	XA1	12	XA0
13	XD0	14	XD1
15	XD2	16	GND
17	XD3	18	XD4
19	XD5	20	XD6
21	XD7	22	ROMCS1
23	XA1	24	MDRCL
25	XA11	26	XA9
27	XA8	28	NC
29	NC	30	NC
31	MWTCL	32	VCC

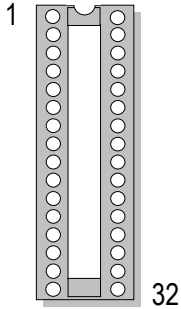

J16: Power Mode Sel. - 6-pin Header

Pin #	Signal Name
1-2	SINGL 5V
2-3	SINGLE 5V ACPI
NC	ATX POWER (5V/SB5V)

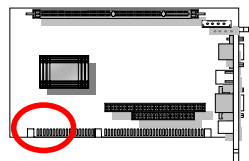

J17: Power Connector – 4-pin Header (P4 Molex 5mm)

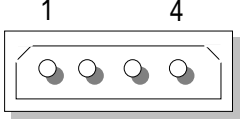
	Pin #	Signal Name
	1	SB5V
	2	GND
	3	GND
	4	+12V

J18: Power Header

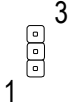
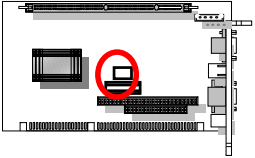
	Pin #	Signal Name	
	1	PSON-	
	2	GND	
	3	SB5V	

J19: RS232/RS485 Select - 3-pin Header

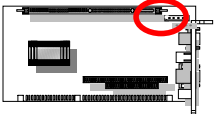
	Pin #	Signal Name	
	1-2	COM2 / RS232	
	2-3	RS485	

J20: RS485 - 2.54 Ø, 2-pin Molex Header

	Pin #	Signal Name
	1	RS485+
	2	RS485-

J21 : FDD Connector - 34-pin Box Header (17x2)

Pin #	Signal Name	Pin #	Signal Name
1	GND	2	DENSEL
3	GND	4	NC
5	GND	6	NC
7	GND	8	INDEX\
9	GND	10	MTRO\
11	GND	12	DS1\
13	GND	14	DS0\
15	GND	16	MTR1\
17	GND	18	DIR\
19	GND	20	STEP\
21	GND	22	WD\
23	GND	24	WG\
25	GND	26	TR0\
27	GND	28	WP\
29	GND	30	RD\
31	GND	32	HDSEL\
33	GND	34	DSKCHG\

J22 : COM1 – 9-pin D-Sub Connector

Pin #	Signal Name	Pin #	Signal Name
1	DCD1	2	RXD1
3	TXD1	4	DTR1
5	GND	6	DSR1
7	RTS1	8	CTS1
9	RI1	10-11	GGND

J23 : COM1 - 10-pin Box Header

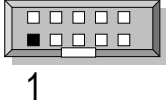
	Pin #	Signal Name	Pin #	Signal Name
	1	DCD1	2	RXD1
	3	TXD1	4	DTR1
	5	GND	6	DSR1
	7	RTS1	8	CTS1
	9	RI1	10	VCC

J24 : COM2 - 10-pin Box Header

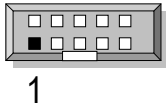
	Pin #	Signal Name	Pin #	Signal Name
	1	DCD2	2	RXD2
	3	TXD2	4	DTR2
	5	GND	6	DSR2
	7	RTS2	8	CTS2
	9	RI2	10	VCC

J25 : Printer Connector - 26-pin Box Header

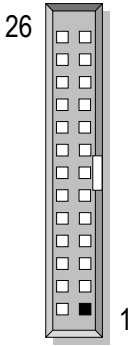
	Pin #	Signal Name	Pin #	Signal Name
	1	STB-	2	PD0
	3	PD1	4	PD2
	5	PD3	6	PD4
	7	PD5	8	PD6
	9	PD7	10	ACK-
	11	BISY	12	PE
	13	SLCT	14	AFD-
	15	ERR-	16	PRINIT-
	17	SLIN-	18	GND
	19	GND	20	GND
	21	GND	22	GND
	23	GND	24	GND
	25	GND	26	NC

J26 : ISA Bus SL36 – 36-pin Gold finger (Total 98 pins)

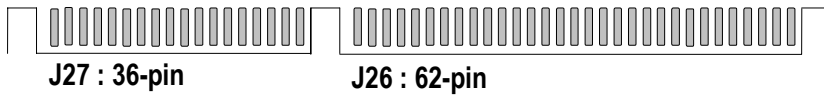

Pin #	Signal Name	Pin #	Signal Name
1 (A1)	SBHE	2 (B1)	MEMCS16
3	LA23	4	IOCS16
5	LA22	6	IRQ10
7	LA21	8	IRQ11
9	LA20	10	IRQ12
11	LA19	12	IRQ15
13	LA18	14	IRQ14
15	LA17	16	DACK0
17	MEMR	18	DRQ0
19	MEMW	20	DACK5
21	SD8	22	DRQ5
23	SD9	24	DACK6
25	SD10	26	DRQ6
27	SD11	28	DACK7
29	SD12	30	DRQ7
31	SD13	32	VCC
33	SD14	34	MASTER
35	SD15	36	GND

J27 : ISA Bus SL62 – 62-pin Gold finger (Total 98 pins)

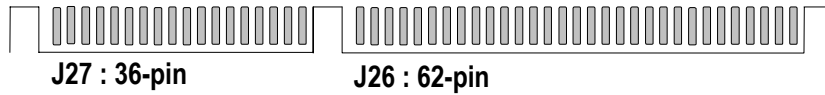

Pin #	Signal Name	Pin #	Signal Name
1 (A1)	IOCHCK	2 (B1)	GND
3	SD7	4	RSTDRV
5	SD6	6	VCC
7	SD5	8	IRQ9
9	SD4	10	-5V
11	SD3	12	DRQ2
13	SD2	14	-12V
15	SD1	16	OWS
17	SD0	18	+12V
19	IOCHRDY	20	GND
21	AEN	22	SMEMW
23	SA19	24	SMEMR
25	SA18	26	IOW
27	SA17	28	IOR
29	SA16	30	DACK3
31	SA15	32	DRQ3
33	SA14	34	DACK1
35	SA13	36	DRQ1
37	SA12	38	REFRESH
39	SA11	40	SYSCLK
41	SA10	42	IRQ7
43	SA9	44	IRQ6
45	SA8	46	IRQ5
47	SA7	48	IRQ4
49	SA6	50	IRQ3
51	SA5	52	DACK2
53	SA4	54	TC
55	SA3	56	BALE
57	SA2	58	VCC
59	SA1	60	OSC
61	SA0	62	GND

J28: PC/104 Connector - 64-pin Header Connector (CN1)

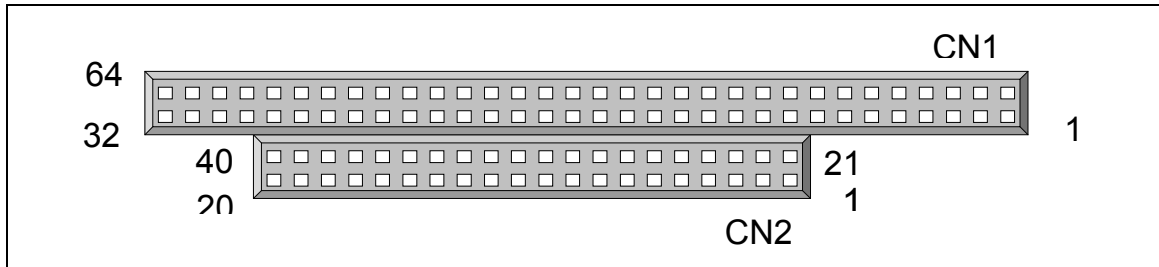

1	IOCHCHK *	2	GND
3	SD7	4	RESETDRV
5	SD6	6	+5V
7	SD5	8	IRQ9
9	SD4	10	-5V
11	SD3	12	DRQ2
13	SD2	14	-12V
15	SD1	16	ENDXFR *
17	SD0	18	+12V
19	IOCHRDY	20	(KEY)
21	AEN	22	SMEMW *
23	SA19	24	SMEMR *
25	SA18	26	IOW *
27	SA17	28	IOR *
29	SA16	30	DACK3 *
31	SA15	32	DRQ3
33	SA14	34	DACK1 *
35	SA13	36	DRQ1
37	SA12	38	REFRESH *
39	SA11	40	SYSCLK
41	SA10	42	IRQ7
43	SA9	44	IRQ6
45	SA8	46	IRQ5
47	SA7	48	IRQ4
49	SA6	50	IRQ3
51	SA5	52	DACK2 *
53	SA4	54	TC
55	SA3	56	SALE
57	SA2	58	+5V
59	SA1	60	OSC
61	SA0	62	GND
63	GND	64	GND

J29 PC/104 Connector - 40pin Header Connector (CN2)

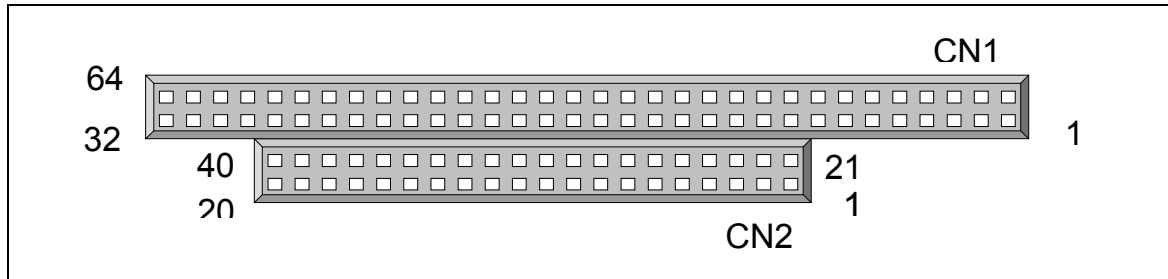

1	GND	2	GND
3	MEMCS16 *	4	SBHE *
5	IOCS16 *	6	LA23
7	IRQ10	8	LA22
9	IRQ11	10	LA21
11	IRQ12	12	LA20
13	IRQ15	14	LA19
15	IRQ14	16	LA18
17	DACK0 *	18	LA17
19	DRQ0	20	MEMR *
21	DACK5 *	22	MEMW *
23	DRQ5	24	SD8
25	DACK6 *	26	SD9
27	DRQ6	28	SD10
29	DACK7 *	30	SD11
31	DRQ7	32	SD12
33	+5V	34	SD13
35	MASTER *	36	SD14
37	GND	38	SD15
39	GND	40	(KEY)

2.5 DiskOnChip Flash Disk

2.5.1 Setup a DiskOnChip ® 2000 Flash Disk

Installation Instructions

1. Make sure the power of ICOP-6042VE is turned OFF.
2. Plug the DiskOnChip 2000 device into its socket. Verify the mounting orientation of the DiskOnChip 2000 is correct (DiskOnChip 2000 pin 1 must be aligned with pin 1 of the socket).
3. Set the address for both DiskOnChip and Flash Disk devices following the instructions below:

Step1: Enter to AMI BIOS Setup Utility while system power on.

Step2: Enter to "Advanced Chipset Setup".

Step3: Select "GPCS Function" to "Enable".

(For DiskOnChip)

Step4: Select "GPCS0 Command" to "MEMR/W 8bit".

Step5: Select "GPCS0 Start Address" to "0C8000 HEX".

Step6: Select "GPCS0 Size" to "8 KBYTE" (go to Step 10).

(For Flash Disk)

Step4: Select "GPCS0 Command" to "MEMR/W 8bit".

Step5: Select "GPCS0 Start Address" to "0E0000 HEX".

Step6: Select "GPCS0 Size" to "64 KBYTE".

Step7: Select "GPCS1 Command" to "IOW 8bit".

Step8: Select "GPCS1 Start Address" to "000100 HEX".

Step9: Select "GPCS1 Size" to "2 BYTE".

Step10: Save changes and exit.

4. Power up the system.
5. During power up, you may observe the messages displayed by the DiskOnChip 2000 when its drivers are automatically loaded into system's memory.
6. At this stage, the DiskOnChip 2000 can be access as any disk in the system.
7. If the DiskOnChip 2000 is the only disk in the system, it will appear as the first disk (drive C: in DOS).
8. If there are more disks besides the DiskOnChip 2000, the DiskOnChip 2000 will appear by default as the last drive, unless it was programmed as first drive. (please refer to the DiskOnChip 2000 utilities user manual).
9. If you want the DiskOnChip 2000 to be bootable: a - copy the operating system files into the DiskOnChip by using the standard DOS command (for example: sys d:) b -

The DiskOnChip should be the only disk in the systems or should be configured as the first disk in the system (c:) using the DUPDATE utility

For more information on DiskOnChip2000 technology, visit M-Systems Web site <http://www.m-sys.com> where you can find Utilities Manual, Data Sheets and Application Notes. In addition, you can find the latest DiskOnChip 2000 S/W Utilities.

2.6 Watchdog Timer

The watchdog timer uses a 32.768 KHz frequency source with a 24-bit counter. Its time range stretches from 30.5 ms to 512 sec. with a resolution of 30.5 ms. When the watchdog times out, a System RESET, NMI or IRQ can be invoked. Watchdog timer control and the 24-bit counter itself occupy 6 consecutive 8-bit address locations.

When functioning properly, the system resets the watchdog timer periodically to prohibit that it times out. If the watchdog timer times out, it will RESET the system, or generate and NMI or IRQ, depending on its configuration.

Watchdog or System Timer

Another great application is to generate a periodic IRQ signal. Under DOS environment, the 8254, system timer 0, will generate IRQ0 every 54.9 ms. The watchdog is like a system timer 0. It can be programmed to periodically generate a configurable IRQ. It may be clear that the selected IRQ, will no longer be available to the system.

Configuring the Watchdog Timer in the BIOS

The Vortex86 watchdog configuration register can be controlled by software or can be setup in the BIOS. To do so, go to BIOS Setup's "Advanced Chipset Setup"

Watchdog Function	= Enable/Disable
Watchdog Signal	= RESET, NMI or IRQ 3/4/5/6/7/9/10/11/12/14/15
Watchdog Timer	= 1/2/4/8/16/32/64/128/256/512 Seconds

The BIOS setup only offers a limited amount of time-out values. To obtain a more higher resolution of timeout values, refer to the next paragraph "Configuring the Watchdog Timer by Software". Note that in case of using the BIOS setup, the watchdog starts counting the moment it passes the BIOS setup. This means that if you set the time-out period to 1 second, the system will keep rebooting before being able to load operating system or software!

After you have finished configuring your watchdog timer, it reads "Timeout Status & Reset - INDEX 3CH" on page 12; and look at the example on [page 15](#) to find out how to periodically resetting the timeout status to prevent the watchdog timer from invoking a RESET, NMI or IRQ.

Configuring the Watchdog Timer by Software

Chipset configuration registers

The Vortex86 configuration register INDEX 37H, 38H, 39H, 3AH, 3BH, 3Ch are used to control the watchdog functions and/or display its current status.

Enable/Disable watchdog - INDEX 37H

Bit	Value	Action
7	reserved	Do not modify the value of these bits!
6	0 1	Disable watchdog timer Enable watchdog timer
5-0	Other function	Do not modify the value of these bits!

Watchdog time out action - INDEX 38H

Bit	Value	Action
7-4	0000	No output signal
	0001	IRQ3
	0010	IRQ4
	0011	IRQ5
	0100	IRQ6
	0101	IRQ7
	0110	IRQ9
	0111	IRQ10
	1000	IRQ11
	1001	IRQ12
	1010	IRQ14
	1011	IRQ15
	1100	NMI
	1101	System RESET
	1110	No output signal
	1111	No output signal
3-0	Other function	Do not modify the value of these bits!

Watchdog timer - INDEX 39H, 3AH, 3BH

Index	3Bh	3Ah	39h
Bits	D7.....D0	D7.....D0	D7.....D0
counter	[VSB.....LSB]

For example

Index	3Bh	3Ah	39h	Time out
	00h	00h	01h	30.5µs
	00h	00h	02h	61µs
	00h	01h	00h	7.8 ms
	00h	02h	00h	15.6 ms
	01h	00h	00h	2 s
	02h	00h	00h	4 s
	FFh	FFh	FFh	512 s

Timeout Status & Reset - INDEX 3CH

Bit	Value	Action
7	0	Timeout has not occurred
	1	Timeout has occurred
6	1	Reset timer
	0	Has no meaning
5-0		Other function, do not modify these bits

Programming the watchdog

To perform any operation on the Vortex86 configuration registers you always have to unlock first and lock the registers afterwards.

Unlock configuration register

```

mov al, 013h
out 22h, al
nop
nop
mov al, 0c5h
out 23h, al
nop
nop

```

Lock configuration register

```

mov al, 013h
out 22h, al
mov al, 000h
out 23h, al

```

Read the value of a configuration register

For example, read INDEX 3Ch :

Unlock configuration register

```

mov al, 03ch
out 22h, al
nop
nop
in al, 23h
nop
nop
push ax

```

Lock configuration register

```
pop ax ;AL - result
```

Write data to configuration register

For example, write 0FFh to INDEX 3Bh :

Unlock configuration register

```
mov al, 03bh
out 22h, al
nop
nop
mov al, 0ffh
out 23h, al
nop
nop
```

Lock configuration register

Watchdog Program Example

We use the following sequence to initialize the watchdog timer:

- (1) Unlock configuration register.
- (2) Disable watchdog timer by setting INDEX 37H Bit 6 to '0'.
- (3) Set the expected counter value to INDEX 3BH, 3AH, 39H.
- (4) Select timeout action from INDEX 38H Bit 7-4.
- (5) Enable watchdog timer by setting INDEX 37H Bit 6 to '1'.
- (6) Lock configuration register.

Example: Set timeout to 128 sec to generate a system RESET.

```
; Please use MASM to compiler the following program
; Execute under DOS environment
dosseg
. model small
. stack 100h
.code
main proc
    mov ax, 0c513h ; Unlock config. register
    call writechip
    mov ax, 03737h ; Disable watchdog timer
    call readchip
    and al, 10111111b
    xchg ah, al
    call writechip
    mov ax, 0403bh ; Set the expected counter
                    ; value
    call writechip ; to [400000h]
    mov ax, 0003ah ; 30.5*sec*400000h= 128 sec
    call writechip
    mov ax, 00039h
    call writechip
    mov ax, 03838h ; Select "system reset" as
                    ; timeout action
    call readchip
```

```

    and al, 00001111b
    or al, 11010000b
    xchg ah, al
    call writechip
    mov ax, 03737h ; Enable watchdog timer
    call readchip
    or al, 01000000b
    xchg ah, al
    call writechip
    mov ax, 00013h ; Lock config. register
    call writechip
    mov ax, 04c00h
    int 21h
main endp
readchip proc
    out 22h, al
    nop
    nop
    in al, 23h
    nop
    nop
    ret
readchip endp
writechip proc
    out 22h, al
    nop
    nop
    xchg ah, al
    out 23h, al
    nop
    nop
    xchg ah, al
    ret
writechip endp
end main

```

Reset watchdog timer

Resets the watchdog timer periodically to prevent timeout.

```

    mov ax, 0c513h ; Unlock configuration
                    ; register
    call writechip
    mov ax, 03c3ch ; Reset watchdog timer
                    ; counter
    call readchip
    or al, 01000000 ; The counter is reset at
    xchg ah, al ; out 23h, al
    call writechip
    mov ax, 00013h ; Lock configuration
                    ; register
    call writechip

```

(the above code uses readchip and writechip procedures)

Chapter 3

SVGA Setup

3.1 Introduction

The ICOP-6042VE offers high performance/low cost Vortex™ SoC (System on Chip) solution that integrates a x86 compatible processor, high performance North Bridge, advanced hardware GUI engine and Super-South bridge into a single chipset – this SoC design supports the now PC technology, USB, Legacy Removal, CIR, Memory Stick, Smart Card and Slotless Design for a variety of IA (Information Appliance) applications. It also has a built-in VGA controller.

3.1.1 SoC Chipset

The embedded video uses the integrated Ultra-AGP™ VGA controller for Hardware 2D/video/Graphics Accelerators, this board supports conventional analog CRT monitor or flat panel. It is both AGP 4X / Fully DirectX 8 Compliant. It also provides Monitor / Secondary CRT Monitor output. This video SVGA controller supports conventional analog CRT monitor or flat panel. In addition, it also supports interlaced and non-interlaced analog monitors (color and monochrome VGA) in high-resolution modes while maintaining complete IBM VGA compatibility. Multiple frequency (multi-sync) monitors are handled as if they were analog monitors.

3.1.2 Display memory

The VGA controller can drive CRT displays or color panel displays with resolutions up to 1920 x 1440 at 256 colors (True colors). It supports Shared System Memory up to 128 MB.

3.2 Flat Panel BIOS Wiring

The ICOP-6042VE offers high performance/low cost Vortex™ SoC (System on Chip) solution that integrates a x86 compatible processor, high performance North Bridge, advanced hardware GUI engine and Super-South bridge into a single chipset – this SoC design supports the now PC technology, USB, Legacy Removal, CIR, Memory Stick, Smart Card and Slotless Design for a variety of IA (Information Appliance) applications. It also has a built-in VGA controller. Shown on next page are the -

● Supported Flat Panels:

- SHARP 12" DSTN LCD panel P/N : LM12S402
- SHARP 12" LCD connector P/N : HIROSE_DF9B-41P-1V
- SHARP 10" DSTN LCD panel P/N : LM100SS1T522
- SHARP 10" LCD connector P/N : JAE_FI-W31P-HF
- NEC LCD connector P/N : HIROSE DF9C-41P-1V
- PVI 6.4" LCD connector P/N : JST FLH-RSM1-30PIN
- PVI 6.4" LCD connector P/N : DF9A-31P-1V
- NAN YA 3.9" FSTN LCD panel product No. : LCBA7T211M2
- NAN YA 5.7" FSTN LCD panel, the panel P/N : LCBHB_B61_

SHARP 12" DSTN LCD panel P/N : LM12S402
 SHARP 12" LCD connector P/N : HIROSE_DF9B-41P-1V

Vortex™			
Pin	Pin name	Pin	Pin name
1	LCDVCC	2	LCDVCC
3	LCDVCC	4	LCDVCC
5	VBD7(BX7)	6	VBD6(BX6)
7	VBD5(BX5)	8	VBD4(BX4)
9	GND	10	GND
11	VBD3(BX3)	12	VBD2(BX2)
13	VBD1(BX1)	14	VBD0(BX0)
15	VBD11(GX3)	16	VBD10(GX2)
17	VBD9(GX1)	18	VBD8(GX0)
19	GND	20	GND
21	LP/HSYNC	22	SHFCLK
23	ENBLT	24	FLM/VSYNC
25	CONTRAST	26	MOD/LDE
27	THSYNC	28	LLD0(GX4)
29	TVSYNC	30	UUD4
31	UUD3(RX7)	32	DEN
33	GND	34	XCLK
35	LLD5(RX1)	36	LLD6(RX2)
37	LLD7(RX3)	38	LLD2(GX6)
39	LLD3(GX7)	40	LLD4(RX0)
41	LLD1(GX5)	42	GND
43	UUD5	44	UUD2(RX6)
45	GND	46	UUD0(RX4)
47	UUD1(RX5)	48	UUD6
49	UUD7	50	GND

B: SHARP 12" LCD			
Pin	Pin name	Pin	Pin name
2	XCK	1	GND
4	GND	3	GND
6	YD	5	LP
8	GND	7	GND
10	Disp	9	VCC
12	GND	11	GND
14	DL7	13	GND
16	DL5	15	DL6
18	DL3	17	DL4
20	DL1	19	DL2
22	GND	21	DL0
24	GND	23	GND
26	DU1	25	DU0
28	DU3	27	DU2
30	DU5	29	DU4
32	DU7	31	DU6
34	GND	33	GND
36	VCC	35	GND
38	VCON	37	VCC
40	GND	39	NC
		41	GND

LCD	B01	B03	B05	B07	B09	B11	B13	B15	B17	B19	B21	B23	B25	B27	B29	B31	B33	B35	B37	B39	B41
Vortex™	XX	XX	A21	XX	A02	XX	A20	A36	A40	A38	A28	A33	A46	A44	A30	A48	XX	A10	A04		XX
Name	GND	GND	LP	GND	VCC	GND	GND	DL6	DL4	DL2	DL0	GND	DU0	DU2	DU4	DU6	GND	GND	VCC	NC	GND
LCD	B02	B04	B06	B08	B10	B12	B14	B16	B18	B20	B22	B24	B26	B28	B30	B32	B34	B36	B38	B40	
Vortex™	A22	A09	A24	XX	A23	A19	A37	A35	A39	A41	XX	A42	A47	A31	A43	A49	A45	A01	A25	A50	
Name	XCK	GND	YD	GND	DISP	GND	DL7	DL5	DL3	DL1	GND	GND	DU1	DU3	DU5	DU7	GND	VCC	Vcon	GND	

Note : A. Red text signals must connect to red text signals. For example, Sharp LCD panel pin 20 (DL1) must connect to SiS550 LCD connector pin 41(LLD1)
 B. XX means No Connection

SHARP 10" DSTN LCD panel P/N : LM100SS1T522
 SHARP 10" LCD connector P/N : JAE_FI-W31P-HF

Vortex™			
Pin	Pin name	Pin	Pin name
1	LCDVCC	2	LCDVCC
3	LCDVCC	4	LCDVCC
5	VBD7(BX7)	6	VBD6(BX6)
7	VBD5(BX5)	8	VBD4(BX4)
9	GND	10	GND
11	VBD3(BX3)	12	VBD2(BX2)
13	VBD1(BX1)	14	VBD0(BX0)
15	VBD11(GX3)	16	VBD10(GX2)
17	VBD9(GX1)	18	VBD8(GX0)
19	GND	20	GND
21	LP/HSYNC	22	SHFCLK
23	ENBLT	24	FLM/VSYNC
25	CONTRAST	26	MOD/LDE
27	THSYNC	28	LLD0(GX4)
29	TVSYNC	30	UUD4
31	UUD3(RX7)	32	DEN
33	GND	34	XCLK
35	LLD5(RX1)	36	LLD6(RX2)
37	LLD7(RX3)	38	LLD2(GX6)
39	LLD3(GX7)	40	LLD4(RX0)
41	LLD1(GX5)	42	GND
43	UUD5	44	UUD2(RX6)
45	GND	46	UUD0(RX4)
47	UUD1(RX5)	48	UUD6
49	UUD7	50	GND

B: SHARP 10" LCD			
Pin	Pin name	Pin	Pin name
1	GND	2	YD
3	GND	4	LP
5	GND	6	XCK
7	GND	8	VCON
9	Disp	10	VCC
11	VCC	12	VCC
13	GND	14	DU0
15	DU1	16	DU2
17	DU3	18	DU4
19	DU5	20	DU6
21	DU7	22	GND
23	DL0	24	DL1
25	DL2	26	DL3
27	DL4	28	DL5
29	DL6	30	DL7
31	GND		

LCD	B31	B29	B27	B25	B23	B21	B19	B17	B15	B13	B11	B09	B07	B05	B03	B01
Vortex™	A50	A36	A40	A38	A28	A49	A43	A31	A47	A33	A01	A23	A20	A19	A10	A09
Pin Name	GND	DL6	DL4	DL2	DL0	DU7	DU5	DU3	DU1	GND	VCC	DISP	GND	GND	GND	GND
LCD	B30	B28	B26	B24	B22	B20	B18	B16	B14	B12	B10	B08	B06	B04	B02	
Vortex™	A37	A35	A39	A41	A42	A48	A30	A44	A46	A04	A02	A25	A22	A21	A24	
Pin Name	DL7	DL5	DL3	DL1	GND	DU6	DU4	DU2	DU0	VCC	VCC	Vcon	XCK	LP	YD	

NEC LCD connector P/N : HIROSE DF9C-41P-1V

Vortex™			
Pin	Pin name	Pin	Pin name
1	LCDVCC	2	LCDVCC
3	LCDVCC	4	LCDVCC
5	VBD7(BX7)	6	VBD6(BX6)
7	VBD5(BX5)	8	VBD4(BX4)
9	GND	10	GND
11	VBD3(BX3)	12	VBD2(BX2)
13	VBD1(BX1)	14	VBD0(BX0)
15	VBD11(GX3)	16	VBD10(GX2)
17	VBD9(GX1)	18	VBD8(GX0)
19	GND	20	GND
21	LP/HSYNC	22	SHFCLK
23	ENBLT	24	FLM/VSYNC
25	CONTRAST	26	MOD/LDE
27	THSYNC	28	LLD0(GX4)
29	TVSYNC	30	UUD4
31	UUD3(RX7)	32	DEN
33	GND	34	XCLK
35	LLD5(RX1)	36	LLD6(RX2)
37	LLD7(RX3)	38	LLD2(GX6)
39	LLD3(GX7)	40	LLD4(RX0)
41	LLD1(GX5)	42	GND
43	UUD5	44	UUD2(RX6)
45	GND	46	UUD0(RX4)
47	UUD1(RX5)	48	UUD6
49	UUD7	50	GND

B: NEC TFT 800x 600 P/N : NL8060BC31-09			
Pin	Pin name	Pin	Pin name
1	GND	2	CLK
3	GND	4	HSYNC
5	VSYNC	6	GND
7	GND	8	GND
9	R0(RX2)	10	R1(RX3)
11	R2(RX4)	12	GND
13	R3(RX5)	14	R4(RX6)
15	R5(RX7)	16	GND
17	GND	18	GND
19	G0(GX2)	20	G1(GX3)
21	G2(GX4)	22	GND
23	G3(GX5)	24	G4(GX6)
25	G5(GX7)	26	GND
27	GND	28	GND
29	B0(BX2)	30	B1(BX3)
31	B2(BX4)	32	GND
33	B3(BX5)	34	B4(BX6)
35	B5(BX7)	36	GND
37	DENB	38	VCC
39	VCC	40	VCC
41	MODE		

LCD	B01	B03	B05	B07	B09	B11	B13	B15	B17	B19	B21	B23	B25	B27	B29	B31	B33	B35	B37	B39	B41
Vortex™			A29		A36		A20	A36	A19	A16	A28	A41	A39	A33	A12	A08		A05	A32	A02	
Name	GND	GND	VS	GND	R0	R2	R3	R5	GND	G0	G2	G3	G5	GND	B0	B2	B3	B5	DEN	VCC	MOD
LCD	B02	B04	B06	B08	B10	B12	B14	B16	B18	B20	B22	B24	B26	B28		B32	B34	B36	B38	B40	
Vortex™	A34	A27			A23		A37		A20	A15		A38		A42	A11		A06	A45	A01	A03	
Name	CLK	HS	GND	GND	R1	GND	R4	GND	GND	G1	GND	G4	GND	GND	B1	GND	B4	GND	VCC	VCC	

PVI 6.4" LCD connector P/N : JST FLH-RSM1-30PIN

Vortex™			
Pin	Pin name	Pin	Pin name
1	LCDVCC	2	LCDVCC
3	LCDVCC	4	LCDVCC
5	VBD7(BX7)	6	VBD6(BX6)
7	VBD5(BX5)	8	VBD4(BX4)
9	GND	10	GND
11	VBD3(BX3)	12	VBD2(BX2)
13	VBD1(BX1)	14	VBD0(BX0)
15	VBD11(GX3)	16	VBD10(GX2)
17	VBD9(GX1)	18	VBD8(GX0)
19	GND	20	GND
21	LP/HSYNC	22	SHFCLK
23	ENBLT	24	FLM/VSYNC
25	CONTRAST	26	MOD/LDE
27	THSYNC	28	LLD0(GX4)
29	TVSYNC	30	UUD4
31	UUD3(RX7)	32	DEN
33	GND	34	XCLK
35	LLD5(RX1)	36	LLD6(RX2)
37	LLD7(RX3)	38	LLD2(GX6)
39	LLD3(GX7)	40	LLD4(RX0)
41	LLD1(GX5)	42	GND
43	UUD5	44	UUD2(RX6)
45	GND	46	UUD0(RX4)
47	UUD1(RX5)	48	UUD6
49	UUD7	50	GND

B: PVI 6.4" TFT LCD PD064VT2			
Pin	Pin name	Pin	Pin name
1	CLK	2	HSYNC
3	VSYNC	4	GND
5	R0(RX2)	6	R1(RX3)
7	R2(RX4)	8	R3(RX5)
9	R4(RX6)	10	R5(RX7)
11	GND	12	G0(GX2)
13	G1(GX3)	14	G2(GX4)
15	G3(GX5)	16	G4(GX6)
17	G5(GX7)	18	GND
19	B0(BX2)	20	B1(BX3)
21	B2(BX4)	22	B3(BX5)
23	B4(BX6)	24	B5(BX7)
25	GND	26	DENB
27	VCC	28	VCC
29	NC	30	NC

LCD	B29	B27	B25	B23	B21	B19	B17	B15	B13	B11	B09	B07	B05	B03	B01
Vortex™	A01	A03	A20	A06	A08	A12	A39	A41	A15	A42	A44	A46	A36	A29	A34
Pin Name	NC	VCC	GND	B4	B2	B0	G5	G3	G1	GND	R4	R2	R0	VS	CLK
LCD	B30	B28	B26	B24	B22	B20	B18	B16	B14	B12	B10	B08	B06	B04	B02
Vortex™	A50	A02	A32	A05	A07	A11	A33	A38	A28	A16	A31	A47	A37	A45	A27
Pin Name	NC	VCC	DEN B	B5	B3	B1	GND	G4	G2	G0	R5	R3	R1	GND	HS

PVI 6.4” LCD connector P/N : DF9A-31P-1V

Vortex™			
Pin	Pin name	Pin	Pin name
1	LCDVCC	2	LCDVCC
3	LCDVCC	4	LCDVCC
5	VBD7(BX7)	6	VBD6(BX6)
7	VBD5(BX5)	8	VBD4(BX4)
9	GND	10	GND
11	VBD3(BX3)	12	VBD2(BX2)
13	VBD1(BX1)	14	VBD0(BX0)
15	VBD11(GX3)	16	VBD10(GX2)
17	VBD9(GX1)	18	VBD8(GX0)
19	GND	20	GND
21	LP/HSYNC	22	SHFCLK
23	ENBLT	24	FLM/VSYNC
25	CONTRAST	26	MOD/LDE
27	THSYNC	28	LLD0(GX4)
29	TVSYNC	30	UUD4
31	UUD3(RX7)	32	DEN
33	GND	34	XCLK
35	LLD5(RX1)	36	LLD6(RX2)
37	LLD7(RX3)	38	LLD2(GX6)
39	LLD3(GX7)	40	LLD4(RX0)
41	LLD1(GX5)	42	GND
43	UUD5	44	UUD2(RX6)
45	GND	46	UUD0(RX4)
47	UUD1(RX5)	48	UUD6
49	UUD7	50	GND

B: PVI 6.4” TFT LCD V16C6448AC			
Pin	Pin name	Pin	Pin name
1	GND	2	CLK
3	HSYNC	4	VSYNC
5	GND	6	R0(RX2)
7	R1(RX3)	8	R2(RX4)
9	R3(RX5)	10	R4(RX6)
11	R5(RX7)	12	GND
13	G0(GX2)	14	G1(GX3)
15	G2(GX4)	16	G3(GX5)
17	G4(GX6)	18	G5(GX7)
19	GND	20	B0(BX2)
21	B1(BX3)	22	B2(BX4)
23	B3(BX5)	24	B4(BX6)
25	B5(BX7)	26	GND
27	DENB	28	VCC
29	VCC	30	R/L
31	U/D		

LCD	B31	B29	B27	B25	B23	B21	B19	B17	B15	B13	B11	B09	B07	B05	B03	B01
Vortex™	A50	A02	A32	A05	A07	A11	A33	A38	A28	A16	A31	A47	A37	A45	A27	A09
Pin Name	U/D	VCC	DE	B5	B3	B1	GND	G4	G2	G0	R5	R3	R1	GND	HS	GND
LCD	B30	B28	B26	B24	B22	B20	B18	B16	B14	B12	B10	B08	B06	B04	B02	
Vortex™	A01	A03	A42	A06	A08	A12	A39	A41	A15	A20	A44	A46	A36	A29	A34	
Pin Name	R/L	VCC	GND	B4	B2	B0	G5	G3	G1	GND	R4	R2	R0	VS	CLK	

NAN YA 3.9" FSTN LCD panel product No. : LCBA7T211M2

*Also worked on NAN YA 5.7" FSTN LCD panel, the panel P/N : LCBHB_B61_

Vortex™			
Pin	Pin name	Pin	Pin name
1	LCDVCC	2	LCDVCC
3	LCDVCC	4	LCDVCC
5	VBD7(BX7)	6	VBD6(BX6)
7	VBD5(BX5)	8	VBD4(BX4)
9	GND	10	GND
11	VBD3(BX3)	12	VBD2(BX2)
13	VBD1(BX1)	14	VBD0(BX0)
15	VBD11(GX3)	16	VBD10(GX2)
17	VBD9(GX1)	18	VBD8(GX0)
19	GND	20	GND
21	LP/HSYNC	22	SHFCLK
23	ENBLT	24	FLM/VSYNC
25	CONTRAST	26	MOD/LDE
27	THSYNC	28	LLD0(GX4)
29	TVSYNC	30	UUD4
31	UUD3(RX7)	32	DEN
33	GND	34	XCLK
35	LLD5(RX1)	36	LLD6(RX2)
37	LLD7(RX3)	38	LLD2(GX6)
39	LLD3(GX7)	40	LLD4(RX0)
41	LLD1(GX5)	42	GND
43	UUD5	44	UUD2(RX6)
45	GND	46	UUD0(RX4)
47	UUD1(RX5)	48	UUD6
49	UUD7	50	GND

B: NAN YA 3.9" LCD LM211-2			
Pin	Pin name	Pin	Pin name
1	D7	2	D6
3	D5	4	D4
5	D3	6	D2
7	D1	8	D0
9	GND	10	VCC
11	Disp	12	CL2
13	CL1	14	FLM
15	GND	16	VEE

LCD	B16	B15	B14	B13	B12	B11	B10	B09	B08	B07	B06	B05	B04	B03	B02	B01
Vortex™	23.5V	A50	A24	A21	A22	A23	A01	A33	A46	A47	A44	A31	A30	A43	A48	A49
Pin Name	VEE	GND	FLM	CL1	CL2	DISP	VCC	GND	DU0	DU1	DU2	DU3	DU4	DU5	DU6	DU7

Vortex™ & digital RGB data bus and control signal

1. Data bus :

Vortex™	DSTN	Digital RGB	
		18 bit	24 bit
VAD0	LD0	G2	G4
VAD1	LD1	G3	G5
VAD2	LD2	G4	G6
VAD3	LD3	G5	G7
VAD4	LD4		R0
VAD5	LD5		R1
VAD6	LD6	R0	R2
VAD7	LD7	R1	R3
VAD8	UD0	R2	R4
VAD9	UD1	R3	R5
VAD10	UD2	R4	R6
VAD11	UD3	R5	R7
VBD0			B0
VBD1			B1
VBD2		B0	B2
VBD3		B1	B3
VBD4		B2	B4
VBD5		B3	B5
VBD6		B4	B6
VBD7		B5	B7
VBD8			G0
VBD9			G1
VBD10		G0	G2
VBD11		G1	G3
UD4	UD4		
UD5	UD5		
UD6	UD6		
UD7	UD7		

2. Control signal :

Vortex™	DSTN	Digital RGB
VADE	MOD/LDE	
VAHSYNC	LP/HSYNC	
VAVSYNC	FLM/VSYNC	
DISPOFF	ENBLT	
PLDXCLK	SHFCLK	
VBDE		DEN
VBHSYNC		HSYNC
VBVSYNC		VSYNC
VBGCLK		XCLK
VDDEN	Power control	Power control

Chapter 4

Network Interface

4.1 Introduction

The Realtek RTL-8100B 10/100Mbps Ethernet controller board supports both 10/100BASE-T and Coax 10Base-2 'BNC' connectors, and allows direct connection to your 10/100Mbps Ethernet based Local Area Network for full interaction with local servers, wide area networks such as the Internet.

I/O and IRQ settings can be done by software with the supplied utility software, or it can be set for Plug and Play compatibility. The controller supports : Full-Duplex Ethernet function to double channel bandwidth, auto media detection.

4.2 Software Support

- On-board EEPROM (93C46) programming
- Setup/Diagnostic program for DOS
- Help utility for easy installation
- RPL boot ROM for Novell Netware, Microsoft NT
- NDIS2 (DOS, OS/2, Lantastic, WFW3.11, K&K)
- NDIS3, NDIS4, NDIS5 for WIN95, 98, NT3.51, 4.0, 5.0, WFW3.11
- Netware 16-bit ODI driver for DOS, OS/2 and 32-bit ODI driver for Netware 3.x, 4.x, 5.0 Server
- Packet driver for UNIX Client
- SCO Unix driver
- Linux driver

All operating systems that support standard NE2000

Warranty

This product is warranted to be in good working order for a period of one year from the date of purchase. Should this product fail to be in good working order at any time during this period, we will, at our option, replace or repair it at no additional charge except as set forth in the following terms. This warranty does not apply to products damaged by misuse, modifications, accident or disaster. Vendor assumes no liability for any damages, lost profits, lost savings or any other incidental or consequential damage resulting from the use, misuse of, originality to use this product. Vendor will not be liable for any claim made by any other related party. Return authorization must be obtained from the vendor before returned merchandise will be accepted. Authorization can be obtained by calling or faxing the vendor and requesting a Return Merchandise Authorization (RMA) number. Returned goods should always be accompanied by a clear problem description.