

- **ISaGRAF Ver.3 SoftLogic**
- **5 IEC 61131-3 Standard Open PLC Languages + Flow Chart**
- **MiniOS7 Inside**
- **Redundant Power Input**
- **80186, 80 MHz High Speed CPU**
- **768 KB SRAM, 512 KB Flash**
- **Built-in 512 KB Battery backup SRAM to Retain Data**
- **Dual 10/100M Ethernet Port
4 Serial Ports (RS-232/485)**
- **4/8 Hot-Swap Slots for I-87K High Profile I/O Modules**
- **5-digit 7-seg. LED Display**
- **3 Programmable LEDs**

iPAC-8x47 Series (iP-8447/8847) is Dual Ethernet ISaGRAF SoftLogic PAC (Programmable Automation Controller) of ICP DAS iPAC-8000 series. It equips an 80186, 80 MHz CPU running a MiniOS7 operating system, various connectivity (Dual 10/100 Base-TX Ethernet Ports, one RS-232/485 port, one RS-485 port and two RS-232 ports) and 4/8 slots for high performance Parallel I/O modules (High profile I-8K series) and high performance Serial-type I/O modules (Hot-Swap high profile I-87K I/O modules). Users can also choose RS-485 Remote I/O modules (I-7000 series) or expansion units (RU-87Pn or I-87Kn) plugged with high profile I-87K serial I/O modules. Compared to I-8xx7, iPAC-8x47 series is 2 ~ 4 times faster!

The ISaGRAF PAC supports ISaGRAF Workbench Ver.3 :

- **IEC 61131-3 Standard Open PLC Programming Languages + Flow Chart:**
 1. Ladder
 2. Function Block
 3. SFC
 4. ST
 5. IL
 6. Flow Chart.
- **Auto-Scan I/O**
- **Simulate program even without controller**
- **Debug on-line**
- **Control on-line**
- **Simple graphic HMI**

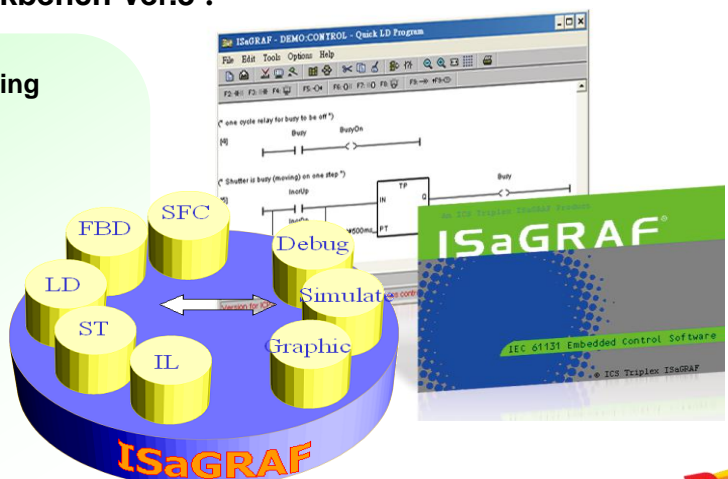

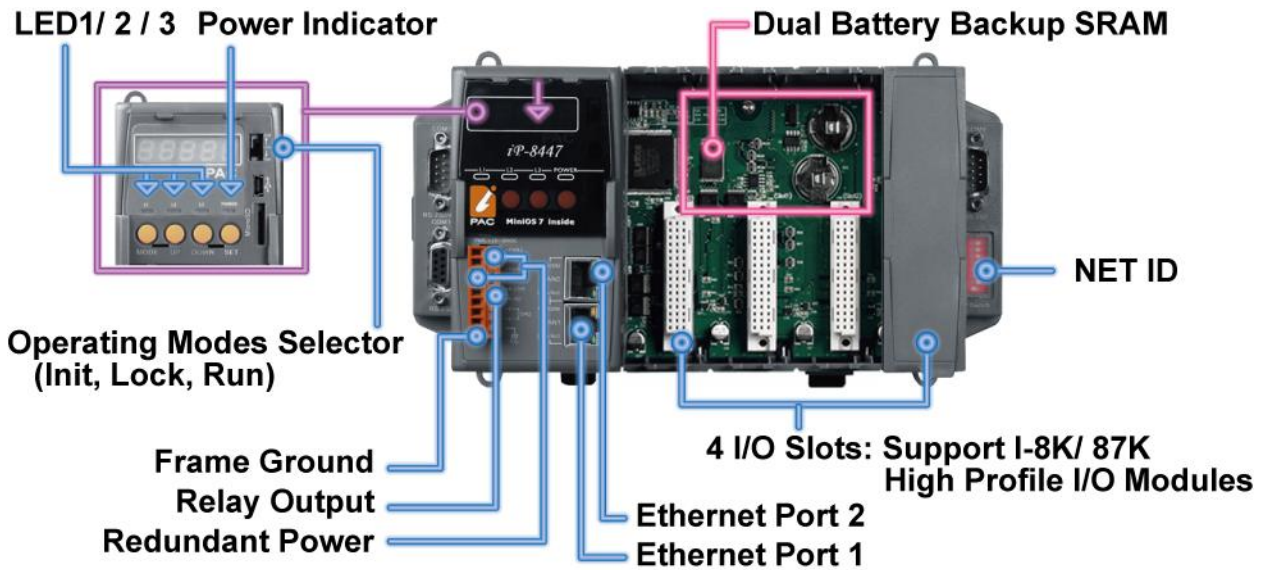

► Hardware Features

• Powerful CPU Module

- ☑ 80186, 80 MHz, or compatible

• Large SRAM: 768 KB

• 512 KB FLASH Memory

- ☑ 100,000 erase/write cycles

• 16 KB EEPROM

• 31 bytes NVRAM

- ☑ Battery backup, data valid up to 5 years

• Built-in Real Time Clock

• 64-bit Hardware Serial Number

- ☑ Protecting software & applications

• Rich Communication Interface

- ☑ RS-232 / RS-485
- ☑ Ethernet

• I/O Slots: 4 / 8 Slots

- ☑ Accept Parallel I/O board: **High Profile I-8K** I/Os
- ☑ Accept Serial I/O board: **High Profile I-87K** I/Os

• I/O Module Hot-Swap Ability

- ☑ Hot-Swap High Profile I-87K I/O modules

• Watchdog Timer Increase Reliability

• Dual Battery-Backup SRAM (512 KB)

- ☑ Retain the data for 5 years while power off
- ☑ Avoid data lost while replacing a new battery

• Dual Ethernet Ports

- ☑ Redundant 10/100M Ethernet communication

• Redundant Power Inputs

- ☑ Prevent from failing by one of the power loss

• Ventilated Housing Design Allows Operation Between -25 ~ +75°C

► Software Features :

• OS: MiniOS7

• Development Software: ISaGRAF Ver.3

- ☑ ISaGRAF Version 3
- ☑ Running on Windows 95/98/NT/2000/XP
- ☑ Single design environment
- ☑ Provide **6** PLC syntaxes (**5** IEC 61131-3 Standard)
- ☑ Code Size: Max. 64 KB ISaGRAF code size
- ☑ Support off-line simulation
- ☑ On-line debugging, monitoring and control
- ☑ Easy integrating to HMI/MMI

• Support Modbus Master

- ☑ RTU, ASCII, RS-232/485/422

• Support Modbus RTU/TCP Slave

- ☑ Modbus RTU (RS-232/485/422) Slave
- ☑ Modbus TCP/IP Slave (Max. 6 Ports)

• Support Data Exchange

- ☑ Ebus: Through Ethernet
- ☑ Fbus: Through RS-485
- ☑ PAC to PAC

• Support CAN/CANopen

• Support FRnet I/O (via I-8172W)

• Support Motion Control

• Support Send Email with One File

• Support SMS: Short Message Service

- ☑ GSM modem

• Support Wireless Communication

- ☑ Radio Wireless

• Support Data-Recorder & Data-Logger

• Support Auto-report Acquisition Data & Control

● GPS Applications: ISaGRAF PAC plus I-87211W or GPS-721

- WP-8xx7, VP-2xW7, iP-8xx7, μPAC-7186(P)EG can support one I-87211W (slot 0-7) or I-87211W / GPS-721 as RS-485 remote GPS I/O.
- For doing auto-time-synchronization and getting local Longitude and Latitude.
- Please refer to www.icpdas.com > FAQ > Software > ISaGRAF Ver.3 (English) > 107
- More GPS receivers at www.icpdas.com > Products > Wireless Modem. GSM/GPRS/ZigBee > GPS receiver

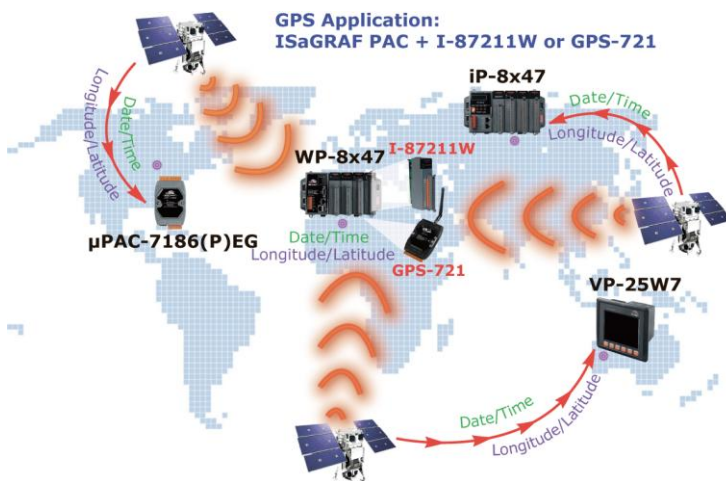

● ZigBee Wireless Solution

- The iP-8xx7 plus ZB-2550P and ZB-2551P RS-232/ 485 Converters can apply wireless communication, reduce the wiring cost, and achieve the mission of remote I/O control and data acquisition.
- Please refer to www.icpdas.com > FAQ > Software > ISaGRAF Ver.3 (English) > 110

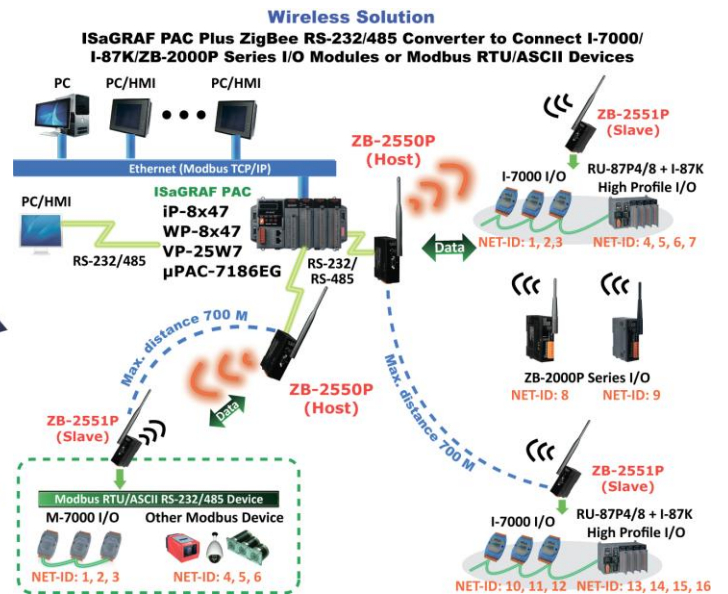

● Auto-report Acquisition Data & Control Data

- iP-8x47 can use UDP/IP to auto-report acquisition data & control data to local or remote internet PC/Server.

Advantage: Every iP-8x47 in the different location doesn't need a fixed IP.

- Please refer to www.icpdas.com > FAQ > Software > ISaGRAF Ver.3 (English) > 065

Stable and Cost-effective Data Acquisition Auto-Report System

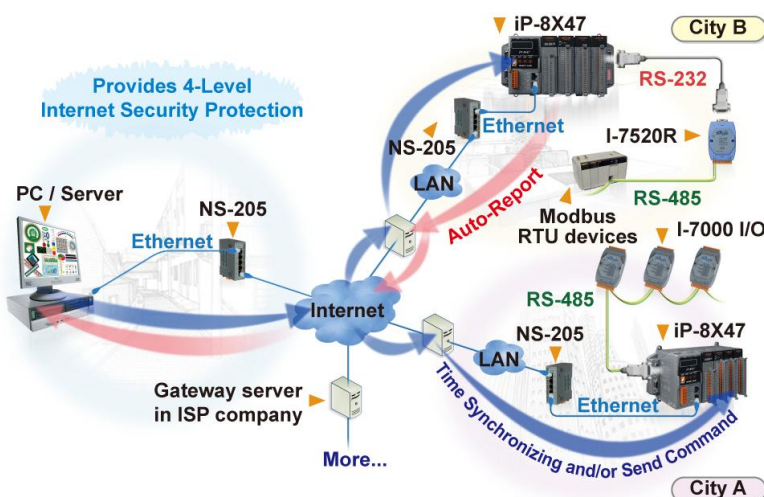

● Fast FRnet Remote I/O

- Fast I/O scan: About 3ms per FRnet scan. (This depends on your ISaGRAF PLC program's scan time, If the ISaGRAF PLC scan time is about 9ms, then the scan time for all will be 9 ms, not 3ms)
- More at www.icpdas.com > FAQ > Software > ISaGRAF Ver.3 (English) > 082

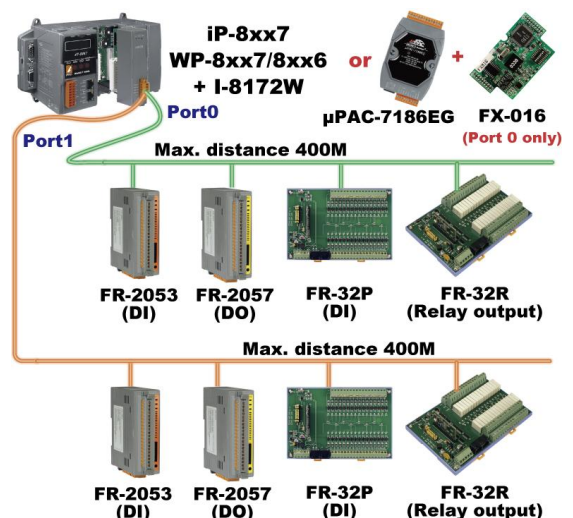

● Ethernet Redundancy for HMI/PC/SCADA

- If one Ethernet cable is broken or damaged, the other one will still handle the Ethernet data exchange for HMI/PC/SCADA (Ex: Indusoft...).

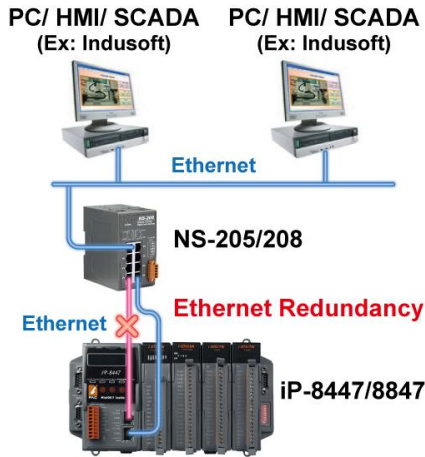

● Stress Monitoring Application of Constructions

- The application mainly used to measure the stress of internal structures or the pressure of water seepage, can be used to monitor bridges, rivers and dams for the surveillance, monitoring, etc....
- More at www.icpdas.com > FAQ > Software > ISaGRAF Ver.3 (English) > 091

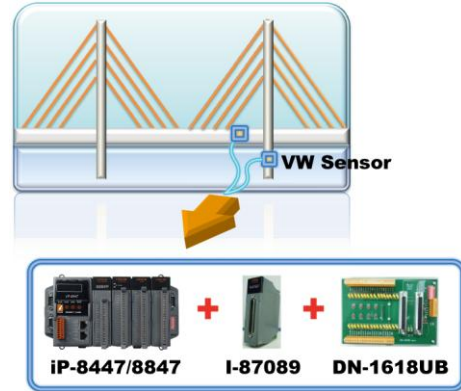

● Send Email with One Attached File

- Please refer to www.icpdas.com > FAQ > Software > ISaGRAF Ver.3 (English) > 067

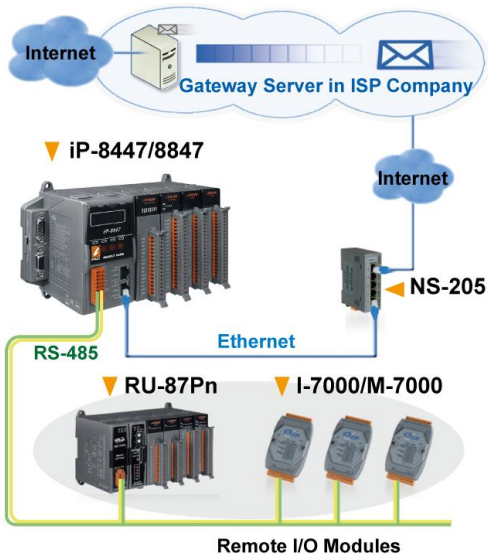

● Local/Remote I/O Expansion & Multi-HMI

About 100 choices of Remote I/O modules: I-7000, M-7000 & I-87K

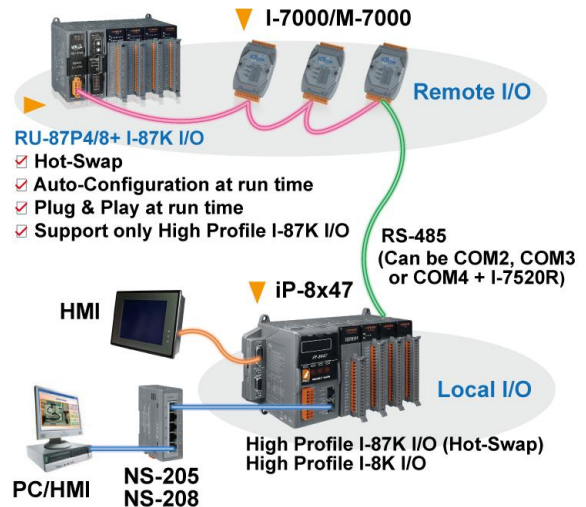

● Data Exchange: Ethernet & RS-485

- Through Ethernet: Ebus
- Through RS-485: Fbus
- PAC to PAC

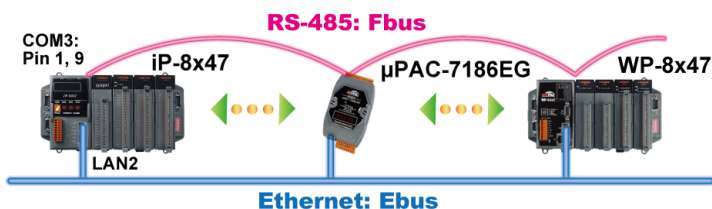

● SMS: Short Message Service

- Short message can be sent in local language format (like Chinese, English,.....others).
- Please refer to www.icpdas.com > FAQ > Software > ISaGRAF Ver.3 (English) > 111

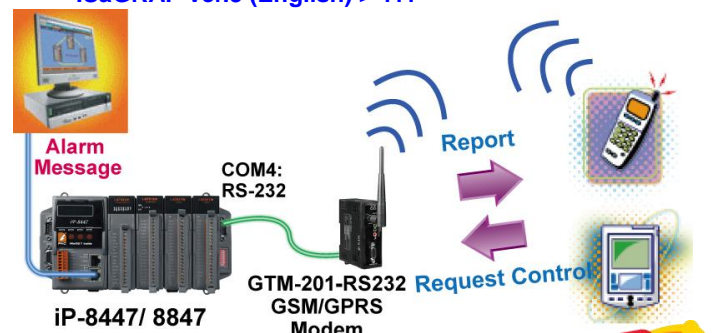

● Modbus Master (RTU, ASCII, RS-232/485/422)

- Support **2** Modbus Master ports at the same time
- COM1, COM2, COM3, COM4 or COM5 (if plugged one I-8112iW/14W/14iW/42iW/44iW board)
- Can link to Modbus PLC or M-7000 I/O or Modbus devices (Power meter, temperature controller, inverter...)

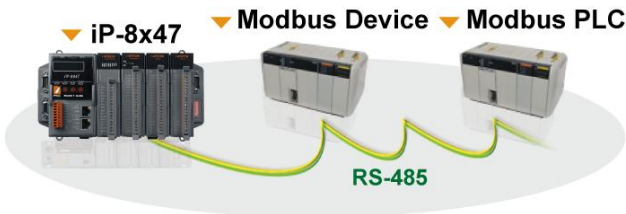

● Integrate with CAN/CANopen Devices and Sensors

- iP-8x47 Supports max. 3 I-7530 (RS-232 to CAN Converter). Please refer to www.icpdas.com > FAQ > Software > ISaGRAF Ver.3 (English) > 086

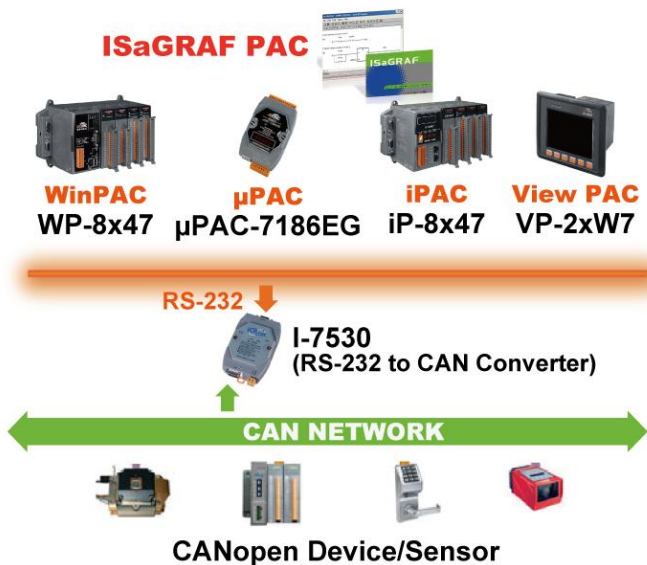

● Detect Hot-Swap I/O

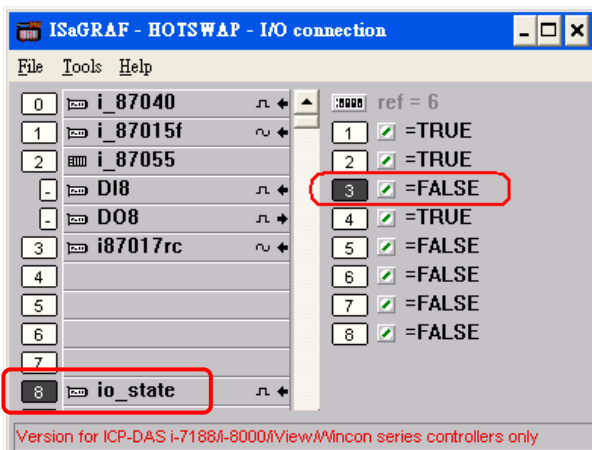

● Modbus RTU/TCP Slave

- Modbus **RTU** : max. **2** PC/HMI/SCADA connections
- Modbus **TCP/IP**: max. **6** PC/HMI/SCADA connections

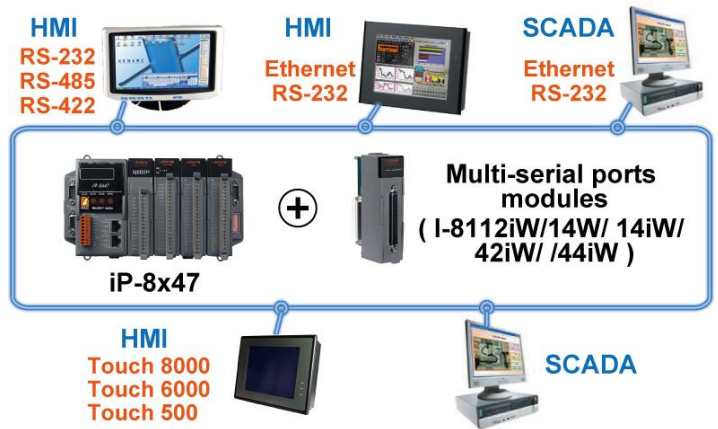

● Data-Recorder & Data-Logger

- Data, date & time can be stored in Dual Battery Backup SRAM, and then PC can load these data via RS-232 or Ethernet.



● Motion Control

- One **I-8091W** can control 2 axes: X-Y plane, or 2 axes independent
- Two **I-8091W** can control 4 axes: X-Y plane + 2 axes independent, or 4 axes independent
- Encoder Modules **I-8093W**: 3-axis ([FAQ-112](#)); **I-8084W**: 4-axis, without Z-index ([FAQ-100](#)); **I-8090W**: 3-axis



● VIP Communication Security

- Set VIP (Very Important IP No.) for Modbus TCP/IP security

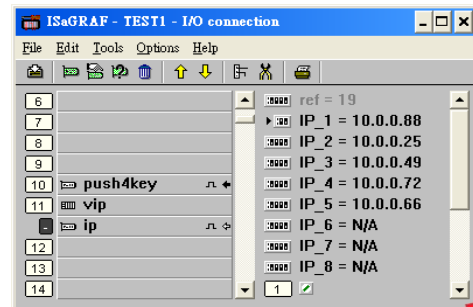



Specifications of iP-8447/ iP-8847

Power Supply	
Power Input	+10 ~ +30 VDC
Isolated	1 kV
Redundant Power Input	Yes, with one power relay (1A @ 24 Vdc) for alarm
Capacity	iP-8447: 0.85 A, 5 V supply to CPU; 5.51 A, 5 V supply to I/O expansion slots, total 30 W iP-8847: 0.9 A, 5 V supply to CPU; 5.1 A, 5 V supply to I/O expansion slots, total 30 W
Consumption	iP-8447: 6.7 W (0.28 A @ 24 V), iP-8847: 7.2 W (0.3 A @ 24 V)
General Environment	
Temperature	Operating: -25 ~ +75 °C Storage : -30 ~ +85 °C
Humidity	5 ~ 95 % RH (non-condensing)
System	
CPU	80186, 80 MHz (16-bit) or compatible
Watchdog Timer	Yes, Default = 0.8 second
RTC (Real Time Clock)	Gives seconds, minutes, hours, day of week, day of month, month & year, valid from 1980 to 2079
SRAM	768 KB
Dual Battery Backup SRAM	512 KB (for 5 years data retention), support up to 1024 retain variables
FLASH Memory	512 KB, 100,000 erase/write cycles with Flash protection switch
NVRAM	31 bytes, battery backup, data valid up to 5 years
EEPROM	16K, retention > 40 years; 1,000,000 erase/write cycles
Serial Number	Yes, 64-bit Hardware Serial Number
SMMI	Yes, on the front panel. 4 push buttons, 3 green programmable LEDs, 1 red power LED and 5-digit 7-Seg. LED (Display message, value, input value, simulate input & output.)
NET ID	8-pin DIP switch to set NET ID as 1 ~ 255
I/O Expansion Slots	
Slot Number	iP-8447: 4 empty slots, iP-8847: 8 empty slots. For high profile parallel (I-8K) & serial (I-87K) I/O boards
Hot-Swap	Support Hot-Swap I-87K high profile I/O module on the slot 0~7 if the module needs to be replaced.
Serial Ports	
Ethernet	10/100 Mbps x 2, Program download port.
COM1	RS-232: TxD, RxD, GND; Speed: 115200 bps max. Program downloads port.
COM2	RS-485: D+, D-; Speed: 115200 bps max.; 3000 Vdc isolated
COM3	RS-232/485; RS-232: TxD,RxD,RTS,CTS,GND, RS-485: D+, D-; Speed: 115200 bps max. Program downloads port.
COM4	RS-232: TxD,RxD,RTS,CTS,DSR,DTR,CD,RI,GND. Speed: 115200 bps max. Full modem signals
Development Software	
ISaGRAF Version 3	IEC 61131-3 standard. Languages: LD, ST, FBD, SFC, IL & FC
Max. Code Size	Accepts max. 64 KB ISaGRAF code size (Appli.x8m must < 64 KB)
Motion Control	
	Can integrate with one I-8091W (2-axis) or two I-8091W (4-axis) to do motion control. Ethernet communication is also available when doing motion control.
PWM Output (Pulse Width Modulation)	
High Speed PWM Module	I-8088W, 8-ch PWM outputs, 10 Hz ~ 500 KHz (non-continuous), duty: 0.1 ~ 99.9%
DO Module as PWM	8-ch max. for one controller. 500 Hz max. For Off=1 & On=1 ms Output Square Curve: Off: 1 ~ 32767 ms, On: 1 ~ 32767 ms Optional D/O Boards: I-8037W, 8041W, 8041AW, 8042W, 8050W, 8054W, 8055W, 8056W, 8057W, 8060W, 8063W, 8064W, 8068W, 8069W (Relay Output boards cannot generate fast square curve)
Counter, Encoder, Frequency	
Parallel DI Counter	8 -ch. max. for 1 controller. Counter Val: 32-bit.; 500 Hz max. Min. ON & OFF width must >1ms Optional DI boards: I-8040W, 8040PW, 8042W, 8048W, 8050W, 8051W, 8052W, 8053W, 8053PW, 8054W, 8055W, 8058W, 8063W.
Serial DI Counter	Counter input: 100 Hz max. Counter value:0~65535 (16-bit) Optional serial I-87K DI boards: I-87040W, 87046W, 87051W, 87052W, 87053W, 87053W-A5, 87054W, 87055W, 87058W, 87059W, 87063W.
Remote DI Counter	All remote I-7000 & I-87K DI modules support counters. 100 Hz max. value: 0 ~ 65535
High Speed Counter	I-87082W: 500 kHz max. 32-bit; I-8084W: 250 kHz max. 32-bit



Specifications of iP-8447/ iP-8847

Encoder	I-8093W : 3-axis Encoder Module, max. 1M Hz for quadrant input mode, max. 4 MHz for pulse/direction and cw/ccw input mode. (FAQ-112) I-8084W: 250 kHz max. , 4-ch encoder, can be dir/pulse, or up/down or A/B phase (Quad. mode), No support Encoder Z-index. (FAQ-100)
Frequency	I-87082W: 2-ch, 1 Hz ~ 100 kHz; I-87088W: 8-ch, 0.1 Hz ~ 500 kHz; I-8084W: 8-ch, 1 Hz ~ 250 kHz;
Protocols	
Modbus Master Protocol	Up to 2 COM Ports, COM1 ~ (COM5 in multi serial port board) can support Modbus RTU Master or ASCII Master protocol to connect to other Modbus Slave devices. Max. Modbus_XXX Function Block amount for 2 ports: 128.
Modbus Slave Protocol	Up to 2 COM Ports, COM1 and one of (COM2, COM3) can support Modbus RTU Slave protocol for connecting ISaGRAF, PC/HMI/OPC Server & MMI panels.
Modbus TCP/IP Protocol	2 Ethernet ports support Modbus TCP/IP Slave Protocol for connecting ISaGRAF & PC/HMI.(Max. 6 connections)
Remote I/O	One of COM2 or COM3 or COM4 supports I-7000 I/O modules & [(I-87Kn base or RU-87P1/2/4/8)+ I-87K High Profile I/O boards] as Remote I/O. Max. 64 Remote I/O module for one PAC
Fbus	Built-in COM3 Port to exchange data between ICP DAS's ISaGRAF PACs.
Ebus	To exchange data between ICP DAS's ISaGRAF Ethernet PACs via Ethernet port. (The LAN2:upper port ONLY)
SMS: Short Message Service	One of COM4 or (COM5 in multi serial port board) can link to a GSM modem to support SMS. User can request data/control the controller by cellular phone. The controller can also send data & alarms to user's cellular phone. Optional GSM/GPRS modem: GTM-201-RS232 (850/900/1800/1900 GSM/GPRS External Modem) or visit to http://www.icpdas.com/products/GSM_GPRS/wireless/GSM_GPRS_modem.htm for recommended GSM/GPRS modem
User Defined Protocol	User can write his own protocol applied at COM1, COM2, COM3, COM4 (& COM5~COM20 if multi-serial port boards are plugged) by serial communication function blocks.
Modem_Link	COM4 can connect a general Modem. Supports PC to remotely download & monitor the controller.
MMICON/LCD	One of COM3 or COM4 supports ICP DAS's MMICON. The MMICON is featured with a 240 x 64 dot LCD and a 4 x 4 Keyboard. User can use it to display picture, string, integer, float, and input a character, string, integer and float.
Redundant Bus7000	Two ISaGRAF PACs can link to remote I-7000 & I-87K High profile I/O modules at the same time. Only one controller is active to control these Remote I/Os. If one is dead, the other one will take over the control of Remote I/Os.
CAN/CANopen	iP-8x47 can use its COM1,3,4 or (COM5 ~ COM12 resides at the I-8112W/8114W/8114iW RS-232 expansion board) to connect one I-7530 : the RS-232 to CAN converter to support CAN and CANopen devices and sensors. One iP-8x47 supports max.3 RS-232 ports to connect max.3 I-7530. Please refer to www.icpdas.com > FAQ > Software > ISaGRAF Ver.3 (English) FAQ-086.
FRnet I/O	Support Max.4 I-8172W FRnet Master cards to connect FRnet I/O modules (Max. 1024-ch. DI + 1024 -ch. D/O)
Sending E-mail	Actively or passively sending E-mail via Ethernet port through internet. Max.10 receivers for each sending and can send E-mail with an attached file. (Max. file size is about 488 KB)



I/O Modules Selection Guide For iP-8x47 Series

I-8K High Profile (Local) I/O modules : More at www.icpdas.com > Products > PAC - 8K & 87K I/O Modules
Parallel I/O Modules : I-8K High Profile Series

I-8K 類比 I/O 模組	
I-8014W	16-bit 250 K sampling rate 8/16-ch. analog input module (The scan rate cannot reach 250 K when using in the ISaGRAF PAC)
I-8017HW	8-ch. Diff. or 16-ch. Single-ended, 14-bit, High Speed Analog Input Module (current input requires external 125 Ω resistor) . (The scan rate cannot reach 100 K when using in the ISaGRAF PAC)
I-8024W	4-ch. Isolated Analog Output Module (+/- 10 V, 0 ~ +20 mA)
I-8K 數位 I/O 模組	
I-8037W	16-ch. Isolated Open Collector Output Module
I-8040W	32-ch. Isolated Digital Input Module
I-8040PW	32-ch. Isolated Digital Input with Low Pass Filter Module
I-8041W	32-ch. Isolated Open Collector Digital Output Module (Sink)
I-8041AW	32-ch. Isolated Open Collector Digital Output Module (Source)
I-8042W	16-ch. Isolated Digital Input & 16-ch. Isolated Open Collector Digital Output Module



I-8K High Profile (Local) I/O modules : More at www.icpdas.com > Products > PAC - 8K & 87K I/O Modules

I-8046W	16-ch. Isolated Digital Input Module
I-8050W	16-ch. Universal Digital I/O Module
I-8051W	16-ch. Non-Isolated Digital Input Module
I-8052W	8-ch. Differential Isolated Digital Input Module
I-8053W	16-ch. Isolated Digital Input Module
I-8053PW	16-ch. Isolated Digital Input with Low Pass Filter Module
I-8054W	8-ch. Isolated Digital Input Module & 8-ch. Isolated Open Collector Digital Output Module
I-8055W	Non-Isolated 8-ch. Digital Logic Input Module & 8-ch. Open Collector Digital Output Module
I-8056W	16-ch. Non-Isolated Open Collector Output Module
I-8057W	16-ch. Isolated Open Collector Output Module
I-8058W	8-ch. Differential Isolated Digital Input Module, Max. AC/DC Input : 250 V
I-8060W	6-ch. Relay Output Module, AC: 0.6 A @ 125 V ; 0.3 A @ 250 V, DC: 2 A @ 30 V
I-8063W	4-ch. Diff. Isolated Digital Input & 4-ch. Relay Output Module, AC : 0.6 A @ 125 V ; 0.3 A @ 250 V
I-8064W	8-ch. Power Relay Output Module, AC: 5 A @ 250 V, DC: 5 A @ 30 V
I-8068W	4-ch. Form-A, 5 A @ 250 VAC/28 VDC & 4-ch. Form-C, 5 A (NO)/3 A (NC) @ 277 VAC/30 Vdc Relay Output
I-8069W	8-ch. PhotoMOS Relay Output Module, Max. AC/DC: 1 A @ 60 V
I-8K 計數器/頻率 模組	
I-8084W	4-ch. Encoder, can be dir/pulse, or up/down or A/B phase (Quad. mode), Not support Encoder Z-index
I-8088W	8-ch. PWM Output and 8-ch. isolated DI Module, 10 Hz ~ 500 kHz (non-continuous).
I-8K 運動控制模組	
I-8093W	3-axis Encoder Module, max. 1M Hz for quadrant input mode, max. 4M Hz for pulse/direction and
I-8091W	2-axis Stepping/Servo Motor Control Card without encoder input
I-8090W	3-axis Encoder Module
I-8K 通訊模組	
I-8112iW	2-ch. Isolated RS-232 Expansion Module
I-8114W	4-ch. Non-Isolated RS-232 Expansion Module
I-8114iW	4-ch. Isolated RS-232 Expansion Module
I-8142iW	2-ch. Isolated RS-422/485 Expansion Module
I-8144iW	4-ch. Isolated RS-422/485 Expansion Module
I-8172W	2-port FRnet Module

RS-485 遠程 I-87K I/O 高卡模組 : 請參見 www.icpdas.com > Products > PAC - 8K & 87K I/O Modules

串列式 I/O 模組 : I-87K 高卡系列 (可熱插拔)

I-87K 類比 I/O 模組	
I-87005W	8-ch. Thermistor input and 8-ch. digital output module
I-87013W	4-ch. , 16-bit, 10 Hz (Total), 2/3/4-wire RTD Input Module with Open Wire Detection
I-87015W	7-ch. , 16-bit, 12 Hz (Total), RTD Input Module with Open Wire Detection (for short sensor distance)
I-87015PW	7-ch. RTD Input Module with 3-wire RTD lead resistance elimination and with Open Wire Detection (for long sensor distance)
I-87017RW	8-ch. Diff. , 16/12-bit, 10/60 Hz (Total) Analog Input Module with 240 V _{rms} Over Voltage Protection, Range of -20 mA ~ +20 mA Requires Optional External 125 Ω Resistor
I-87017RCW	8-ch. Diff. , 16/12-bit, 10/60 Hz (Total) Current Input Module
I-87017W	8-ch. Analog Input Module
I-87017W-A5	8-ch. High Voltage Input Module
I-87018RW	8-ch. Thermocouple Input Module. Recommend to use the better I-87018ZW.
I-87018W	8-ch. Thermocouple Input Module. Recommend to use the better I-87018ZW.
I-87018ZW	10-ch. Diff. , 16-bit, 10 Hz (Total), Thermocouple Input Module with 240 V _{rms} Over Voltage Protection, Open Wire Detection, Range of +/-20 mA, 0~20 mA, 4~20 mA requires Optional External 125 Ω Resistor
I-87019RW	8-ch. Diff. , 16-bit, 8 Hz (Total), Universal Analog Input Module with 240 V _{rms} Over Voltage Protection, Open Wire Detection (V, mA, Thermocouple; Range of -20 mA ~ +20 mA need to set Jumper on board)
I-87024CW	4-ch. 12-bit channel to channel isolated current output module with open-wire detection
I-87024W	4-ch. 14-bit Analog Output Module (0 ~ +5 V, +/- 5 V, 0 ~ +10 V, +/- 10 V, 0 ~ +20 mA, +4 ~ +20 mA)
I-87028CW	8-ch. 12-bit Current Output Module

RS-485 遠程 I-87K I/O 高卡模組：請參見 www.icpdas.com > Products > PAC - 8K & 87K I/O Modules

I-87K 數位 I/O 模組	
I-87040W	32-ch. Isolated Digital Input Module
I-87041W	32-ch. Sink Type Open Collector Isolated Digital Output Module
I-87046W	16-ch. Non-Isolated Digital Input Module for Long Distance Measurement
I-87051W	16-ch. Non-Isolated Digital Input Module
I-87052W	8-ch. Diff. , Isolated Digital Input Module
I-87053PW	16-ch. Isolated Digital Input Module with 16-bit Counters
I-87053W	16-ch. Isolated Digital Input Module
I-87053W-A5	16-ch. 68 ~ 150 VDC Isolated Digital Input Module
I-87054W	Isolated 8-ch. DI and 8-ch. Open Collector DO Module
I-87055W	Non-Isolated 8-ch. DI and 8-ch. Open Collector DO Module
I-87057W	16-ch. Open Collector Isolated Digital Output Module
I-87058W	8-ch. 80 ~ 250 VAC Isolated Digital Input Module
I-87059W	8-ch. Differential 10 ~ 80 VAC Isolated Digital Input Module
I-87063W	4-ch. Diff. Isolated Digital Input and 4-ch. Relay Output Module. 5 A (NO)/3 A(NC) @ 5 ~ 24 VDC ; 5 A(NO)/3 A(NC) @ 0 ~ 250 VAC
I-87064W	8-ch. Relay Output Module, 5 A (47~63 Hz) @ 0~ 250 VAC ; 5 A @ 0~ 30 VDC
I-87065W	8-ch. AC SSR Output Module, AC: 1.0 Arms @ 24 ~ 265 Vrms
I-87066W	8-ch. DC SSR Output Module , DC: 1.0 Arms @ 3 ~ 30 VDC
I-87068W	4-ch. Form A Relay Output and 4-ch. Form C Relay Output Module Form A: 8 A @ 250 VAC ; 8 A @ 28 VDC ; Form C: 5 A (NO)/3 A (NC) @ 277 VAC ; 5 A(NO)/3 A(NC) @ 30 VAC
I-87069W	8-ch. PhotoMOS Relay Output Module, Max. AC/DC: 0.13 A @ 350 V
I-87K 計數器/頻率 模組	
I-87082W	2-ch. Counter/Frequency Module, Isolated or Non-Isolated Inputs
GPS 模組	
I-87211W	Time-Synchronization and GPS module for getting UTC / local time and local Longitude / Latitude.

更多 RS-485 遠程 I/O 模組，請見：

I-7000 : www.icpdas.com > Products > Remote I/O Modules/Units > I-7000 Modules > Selection Guide

M-7000 : www.icpdas.com > Products > Remote I/O Modules/Units > M-7000 Modules > Selection Guide

更多 FRnet 遠程 I/O 模組，請見：

FRnet I/O:

www.icpdas.com > Products > Remote I/O Modules/Units > FRnet Remote I/O Modules > Selection Guide

更多 RS-485 遠程熱插拔 (Hot-Swap) 擴充單元，請見：

RU-87P1/2/4/8 :

www.icpdas.com > Products > Remote I/O Modules/Units > RS-485 Remote I/O Unit > Selection Guide

更多 RS-485 遠程擴充單元，請見：

I-87K1/4/5/8/9:

www.icpdas.com > Products > Remote I/O Modules/Units > RS-485 Remote I/O Unit > Selection Guide



iP-8447/iP-8847 Mechanical Drawing

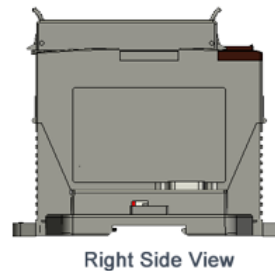
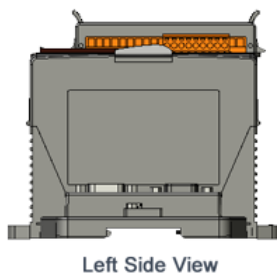
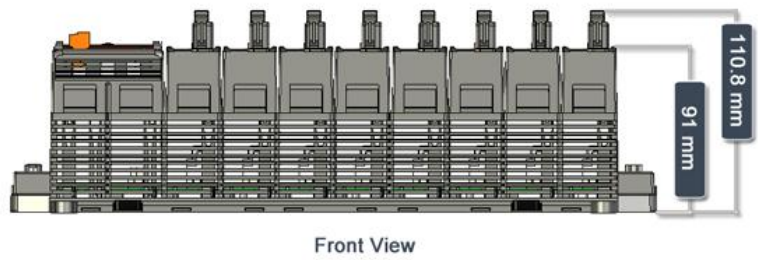
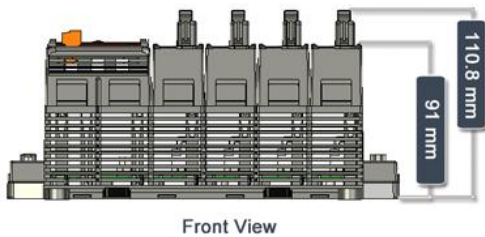
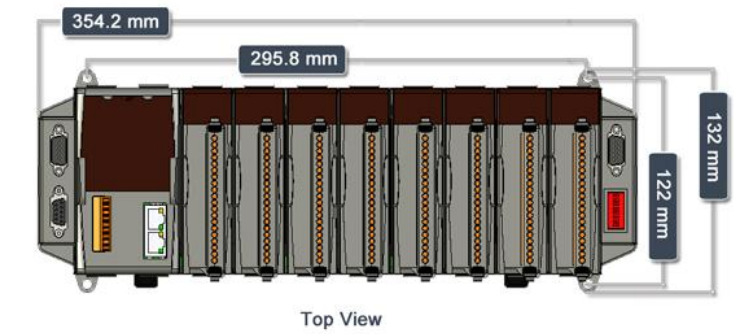
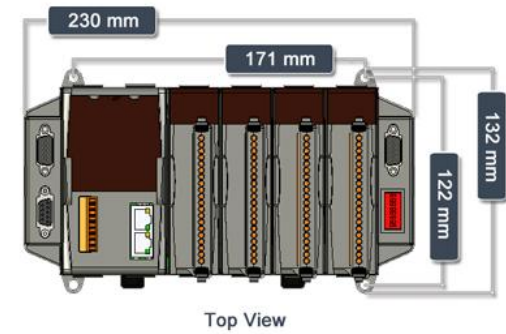

► Ordering Information

iP-8447	4 slots Faster CPU (80 MHz) Dual Ethernet ISaGRAF PAC
iP-8847	8 slots Faster CPU (80 MHz) Dual Ethernet ISaGRAF PAC

► Optional Accessories

* Using ISaGRAF-32 to control more than 32 I/O tags.
(Please refer to ISaGRAF User's Manual Ch. 3.4)

ISaGRAF-256-E	ISaGRAF Workbench Software Ver.3 (256 I/O Tags) with One Application Book (English version) and one USB Dongle
ISaGRAF-256-C	ISaGRAF Workbench Software Ver.3 (256 I/O Tags) with One Application Book (Chinese version) and one USB Dongle
ISaGRAF-32-E	ISaGRAF Workbench Software Ver.3 (32 I/O Tags) with One Application Book (English version)
ISaGRAF-32-C	ISaGRAF Workbench Software Ver.3 (32 I/O Tags) with One Application Book (Chinese version)
ISaGRAF Book-E	ISaGRAF Application Book (English version)
ISaGRAF Book-C	ISaGRAF Application Book (Traditional Chinese version)
NS-205	Unmanaged 5-port Industrial Ethernet Switch (RoHS)
NS-208	Unmanaged 8-port Industrial 10/100 Base-T Ethernet Switch (RoHS)

Note: Do not offer upgrade service from ISaGRAF-32 to ISaGRAF-256.

