

---

# PROFI-8455 User Manual

## Warranty

All products manufactured by ICP DAS are warranted against defective materials for a period of one year from the date of delivery to the original purchaser.

## Warning

ICP DAS assumes no liability for damages consequent to the use of this product. ICP DAS reserves the right to change this manual at any time without notice. The information furnished by ICP DAS is believed to be accurate and reliable. However, no responsibility is assumed by ICP DAS for its use, or for any infringements of patents or other rights of third parties resulting from its use.

## Copyright

Copyright 2007 by ICP DAS Co., LTD. All rights reserved worldwide.

## Trademark

The names used for identification only may be registered trademarks of their respective companies.

## List of Revision

Date	Author	Version	Revision
2007/08/30	Jeff Ma	1.0	Release
2008/01/02	Jeff Ma	1.1	1. Add option, "Clear-Type", to i-87K counter function's DI module. 2. Redesign configuration code for temperature module and i-87K counter function's DI module.
2010/9/8	Jeff Ma	1.2	1. Revised Byte Order Mechanism for Digital I/O Module.

---

## Table of Content

1.	Introduction .....	4
1.1.	Overview .....	4
1.2.	Applications .....	4
1.3.	Features .....	5
1.4.	Specifications .....	6
1.5.	Modules Support .....	7
2.	Hardware .....	8
2.1.	PROFI-8455 Hardware Structure .....	8
2.2.	Bus Wiring .....	9
2.3.	PROFIBUS Cable and Transmission Distance .....	10
2.4.	Status Indicator .....	11
2.5.	Connector .....	13
2.6.	Watchdog mechanism .....	14
2.7.	Node Address .....	15
2.8.	Baud rate support .....	16
3.	PROFIBUS DP System .....	17
3.1.	The flow chart of the DP-slave .....	17
3.2.	Power On / Reset – Rotary switch .....	18
3.3.	Parameterization Data .....	19
	System parameters .....	19
	1. Byte-Order .....	19
	2. Diagnosis Report Period .....	19
	Module parameters for I-8K module .....	20
3.4.	Wait Configuration .....	26
	Configuration Data .....	26
3.5.	Data Exchange .....	30
	3.5.1 Numeric Representation .....	30
	i-8K Series .....	30
	i-87K Module .....	34
	3.5.2 Byte Order and Data Address .....	43
	i-8K Series & i-87K Series - General Digital Input / Output .....	43
	i-87K Series - Digital Input w/ Counter .....	43
	i-8K Series & i-87K Series – General Analog Input ( w/o CJC Read/Offset ) and Analog Output .....	44
	i-8K Series & i-87K Series – General Analog Input (w/ CJC Read/Offset ) .....	44
	i-8K Series & i-87K Series – Counter/Frequency .....	46

---

	Statistic Table of i-8K & i-87K.....	49
3.6.	Diagnostic Message Report .....	53
3.7.	Establish connection with PROFI-8455.....	56
3.8.	Telegram cycle of data exchange.....	57
4.	PROFI-8455 Guideline (Based on SyCon).....	59
4.1.	Preprocessing .....	59
4.2.	I/O View/Modify .....	65
5.	GSD File .....	68

---

# 1. Introduction

## 1.1. Overview

PROFIBUS is an open, digital communication system with a wide range of applications, particularly in the fields of factory automation and process automation. PROFIBUS is suitable for both fast, time-critical applications and complex communication tasks. PROFIBUS-DP is a famous protocol that enables simple, fast, cyclic and deterministic process data exchange between Master and assigned Slave.

The PROFI-8455 Remote I/O Unit is specially designed for the slave device of PROFIBUS DP protocol. It supports up to 4 I/O slots for ICPDAS i-8k series, i-87k Low Profile series and i-87k High Profiles series I/O modules. In addition, we also provide the hot-swap function for i-87k High Profiles series I/O modules. To setup PROFIBUS network, users can choose and configure I/O modules by using the GSD file without any other setting tools.

## 1.2. Applications

- Industrial Automation
- Factory Automation
- Process Automation
- Etc...

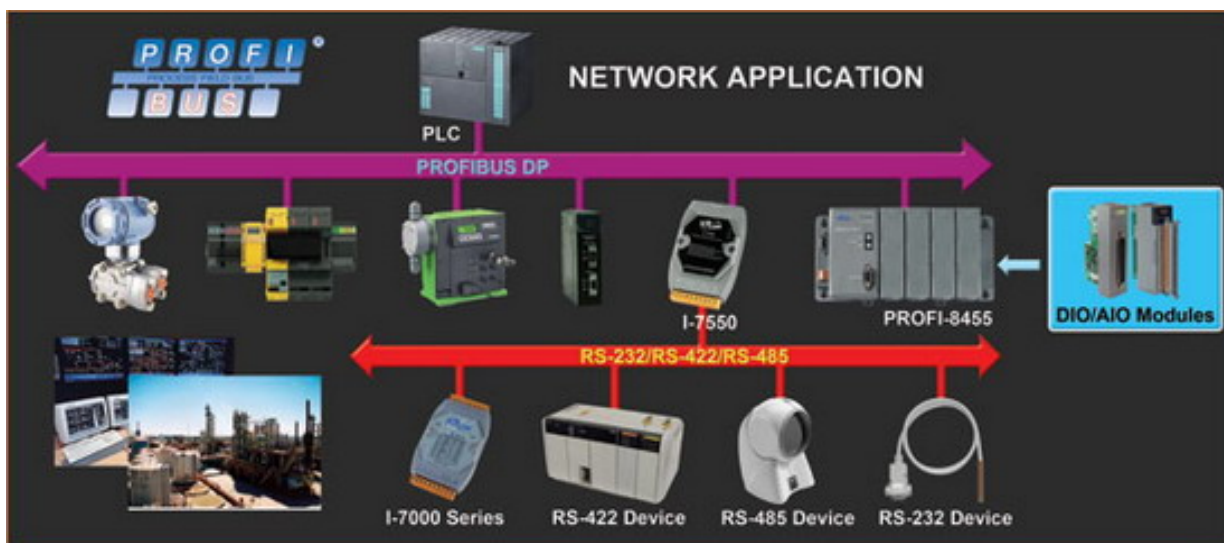

---

### 1.3. Features

Protocol & Hierarchy	DP-V0 Slave
Supports Transmission Rate (Kbps)	9.6, 19.2, 45.45, 93.75, 187.5, 500, 1500, 3000, 6000, 12000
Transmission Rate Setting	detected automatically
Address Setting	0~126 set by Rotary switches
Indicators	PWR, ERR, and RUN LEDs
I/O modules Configuration	Configured by GSD file
Supports I/O modules hot-swap	I-87K High Profile series
Network Isolation Protection	High Speed iCoupler
DC Isolation Protection	3000VDC on PROFIBUS side
Max. Input/Output Data Length	Up to 128Bytes each
Number of Channel of Diag.	39
Device-Related Diag. Type	Offline Detection
Programmable Diag. period	Supported

---

## 1.4. Specifications

Model	PROFI-8455
CPU	80186, 80MHz
Flash	512K Bytes
SRAM	512K Bytes
EEPROM	2K Bytes
Watch Dog Timer	CPU Built-in
Com1	RS-232(Firmware update port)
PROFIBUS Interface	9-pin D-Sub(Female)
PROFIBUS Controller	Siemens SPC3
PROFIBUS Transceiver	ADI ADM2486 iCoupler Isolated Transceiver
Transmission Rate	Up to 12Mbps
I/O Expansion Slot	4 Slots
Power Requirement	10V ~ 30V
Power Supply	25W
Power Consumption	5W
Operating Temp.	-25°C ~ +75°C
Storage Temp.	-30°C ~ +85°C
Humidity	5% ~ 95%
Dimensions	230x110x90 mm

## 1.5. Modules Support

Type	Module Name	Type	Module Name
DI	i-8040 / i-8051 / i-8052 / i-8053 / i-8058  i-87040 / i-87051 / i-87052 / i-87053 / i-87058  i-87040W / i-87046W / i-87051W / i-87052W / i-87053W / i-87053W-A5 / i-87058W	AI	i-8017h / i-8017hs  i-87013 / i-87017 / i-87018  i-87013W / i-87015 / i-87017W / i-87017W-A5 / i-87017R / i-87017RC / i-87018R / i-87018Z / i-87019R
DO	i-8037 / i-8041 / i-8056 / i-8057 / i-8060 / i-8064 / i-8065 / i-8066 / i-8068 / i-8069  i-87041 / i-87057 / i-87064 / i-87065 / i-87066 / i-87068 / i-87069  i-87041W / i-87057W / i-87064W / i-87065W / i-87066W / i-87068W / i-87069W	AO	i-8024  i-87022 / i-87024 / i-87026  i-87024W
DI/O	i-8042 / i-8050 / i-8054 / i-8055 / i-8063 / i-8077  i-87054 / i-87055 / i-87063  i-87054W / i-87055W / i-87063W	Counter / Frequency	i-8080  i-87082

---

## 2. Hardware

### 2.1. PROFI-8455 Hardware Structure





---

## 2.2. Bus Wiring

In order to minimize the reflection effect of the signal transmission, PROFIBUS device has to fit with an active terminal resistor at both first node and last node, as shown below

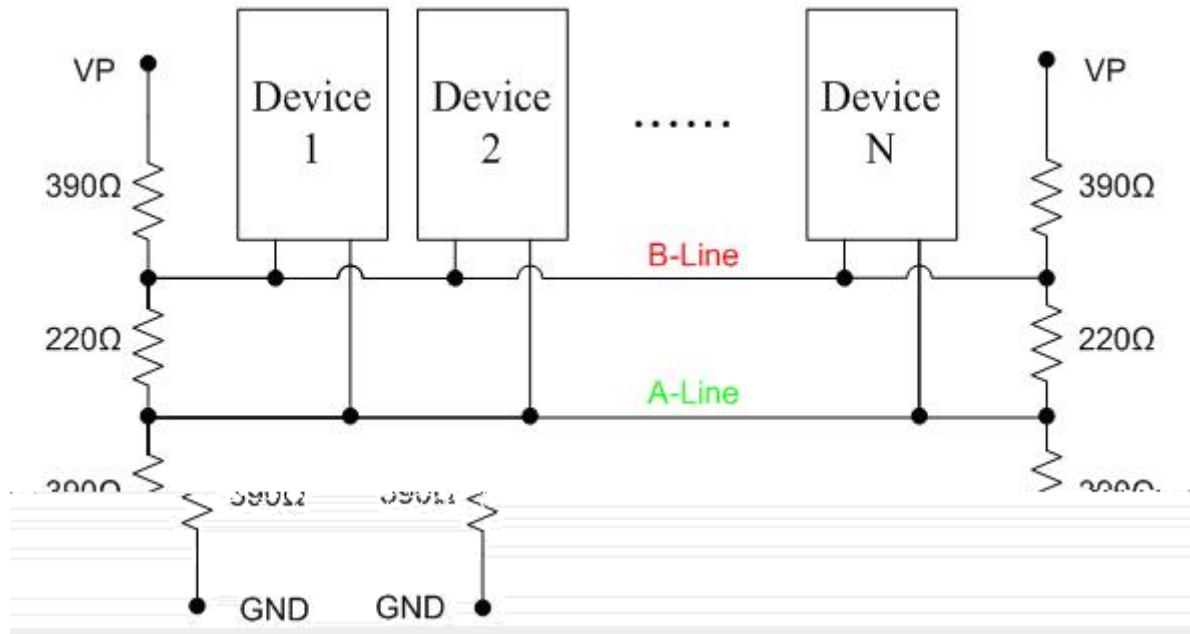

However, the number of station in PROFIBUS network is also restricted. According to PROFIBUS specification, it is up to 32 stations connected in a PROFIBUS segment. If more than 32 stations are connected, the PROFIBUS repeater must be used to link the individual bus segments.

---

### 2.3. PROFIBUS Cable and Transmission Distance

The PROFIBUS cable with following properties has different transmission distance with respect to different transmission rate, shown in the following table

1. Impedance :135~165Ω
2. Capacity : lower than 30 pF/m
3. Loop resistance : lower than 110Ω/Km
4. Wire diameter : larger than 0.65mm
5. Core cross-section : larger than 0.34mm<sup>2</sup>

Transmission Rate(Kbps)	Transmission Distance per Segment (meter)
9.6, 19.2, 45.45, 93.75	1200
187.5	1000
500	400
1500	200
3000, 6000, 12000	100

## 2.4. Status Indicator

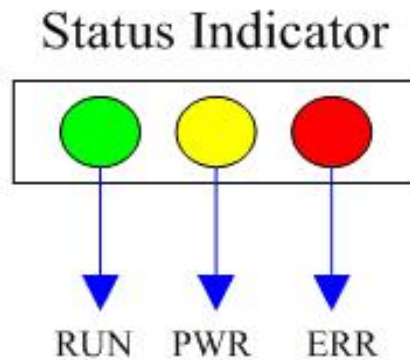

PROFI-8455 provide three types of status indicators, they are PWR LED (yellow), ERR LED (red) and RUN LED (green). When the power is supplied to PROFI-8455, PWR LED will turn on; Before PROFI-8455 gets into the data exchange state, ERR LED will turn on or flash; If CHK\_CFG procedure is finished, RUN LED will turn on and ERR LED will turn off. The table below explains the relationship between linking status and recommend solutions.

Status Indicator	Meaning	Recommend solution
ERR ON & RUN OFF	PROFI-8455 is offline with no valid baud rate (offline mode*)	Check the address setting of PROFI-8455 and DP-master.
ERR Flash (0.1 Sec)	PROFI-8455 detects baud rate, but is still offline.(stop mode*)	Check the DP-Master is ready to communicate with PROFI-8455.
ERR Flash (0.5Sec)	PROFI-8455 Prm is Fault.(Note 1)	Check the setting of PROFI-8455 in the master interface and make sure of the consistency.
ERR Flash (1 Sec)	PROFI-8455's Cfg is fault(Note 2)	Same as above
ERR ON & RUN ON	PROFI-8455 is in clear mode*.	Sets the DP-Master from clear mode to operation mode
ERR OFF & RUN ON	PROFI-8455 is in operation mode*.	
PWR Flash (1 Sec)	PROFI-8455 detect module(s) offline	Find the reason of the fault of corresponding module.

Note 1: "Prm Fault" is the abbreviation of "Parameter Fault"; It means that the number of parameter data which receive from DP-Master is not consistency

---

with DP-Slave (PROFI-8455), and it could due to the difference between module installation and master setting.

Note 2:“Cfg Fault” is the abbreviation of “Configuration Fault”, it means that the number of configuration data which receive from DP-Master is not consistency with DP-Slave (PROFI-8455), and it could due to the wrong order of installation.

Note \*: there are four kinds of state in PROFIBUS DP Master.

1. Offline mode: Master not active on the bus.
2. Stop mode: Master only transmit token on the bus, and PROFIBUS DP is not active.
3. Clear mode: DP Master active, but all output are zero or set to fail-safe state.
4. Operate mode: DP Master full active.

---

## 2.5. Connector

The connector of PROFI-8455 is shown below

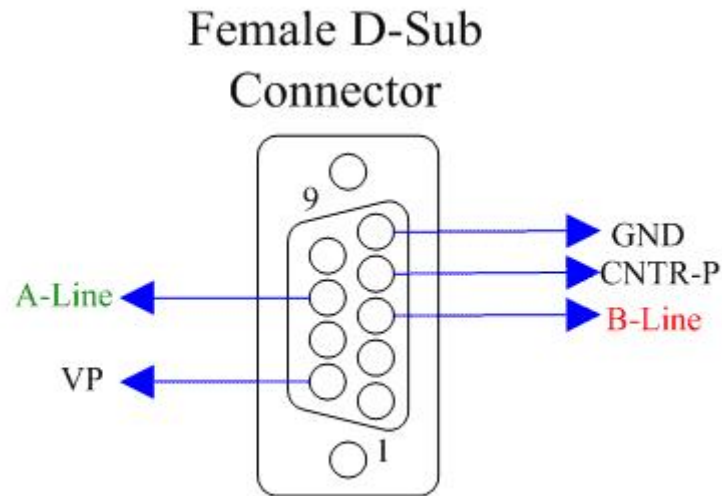

Pin No.	Signal	Meaning
3	B-Line	Receive/Transmit data - plus
4	CNTR-P	Repeater control signal, RTS signal
5	GND	Power ground of active terminator
6	VP	Power 5 volt of active terminator
8	A-Line	Receive/Transmit data - minus

Note: The connector of PROFI-8455 has no terminators; users must use the connector with the terminator inside. The power of the terminator will provide by PROFI-8455 and Master.

---

## 2.6. Watchdog mechanism

There is a built-in watchdog timer to monitor the linking status between PROFI-8455 and Master. In order to ensure an error-free connection, watchdog mechanism divides into three stages.

In the first stage, watchdog detects the start delimiter whether valid or not after the status of power supplied or system reset. If no SD1 telegram, SD2 telegram, or SD3 telegram are received completely, PROFI-8455 will change the baud rate and continues detecting the correct baud rate. This stage is called “Baud Search”.

If the watchdog has detected a valid SD telegram, it goes into the second stage. In this stage, the watchdog monitors the integrity of the telegram. When watchdog timer is expired and PROFI-8455 doesn't receive the complete telegram, PROFI-8455 will go to “Baud Search” state. This stage is called “Baud Control”.

After PROFI-8455 finishes initializing, PROFI-8455 waits for receiving the Set\_Prm telegram. If PROFI-8455 receives the Set\_Prm telegram with “WD\_On=1”, then watchdog goes into DP\_Control and monitors the telegram in Twd time. Otherwise, watchdog remains in the “Baud Control” state. This stage is called “DP\_Control”.

Beside the watchdog mechanism mentioned above, i-87K modules with analog output or digital output have their own host watchdog to monitor the status of PROFI-8455. If PROFI-8455 lost the control of DP-Master (due to any unpredictable fault), it can't send a specific watchdog clear command to flush the watchdog timer of i-87K modules. Then the module will go to safe mode. There are three kinds of safe-value in safe-mode, they are “retain last valid value”, “clear(zero)”, and “switch to substitute value”.

## 2.7. Node Address

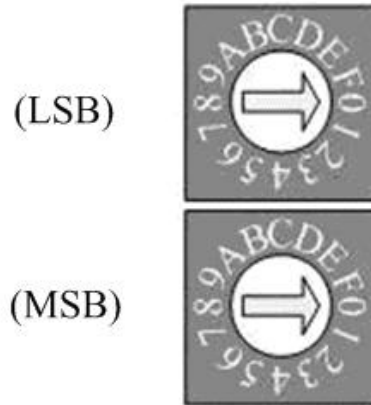

The figure shown above is the hexadecimal rotary switch. It dominates the node (station) address of PROFI-8455. The switch which labeled MSB is high nibble of address and the other one is low nibble of address.

According to PROFIBUS specification, the station address which from 0 to 126 is valid, and the address 126 is a special address that supports the remote setting SSA telegram from Class 2 DP-Master. PROFI-8455 uses the value of rotary switch as its address if the address is valid. While the address is invalid, PROFI-8455 will load the pre-saved value in EEPROM. Moreover, if the address is invalid (126) again, PROFI-8455 awaits the SSA telegram and applies it. (Note: If you want to clear the setting stored in EEPROM, you should adjust rotary switch to FF before the power is supplied).

Rotary Switch(dec)	Pre-saved address (EEPROM)	SSA Telegram	PROFI-8455 Station Address
0~125	Don't care	No Accept	Rotary Switch
126~254	0~125	No Accept	Pre-saved address (EEPROM)
	126 (default)	Accept with address 0~125	SSA Telegram and save address to EEPROM
	127~254	impossible	N/A
255	Clear to 126	Accept with address 0~125	SSA Telegram and save address to EEPROM

Note 1: Only one DP-Slave station with address 126 is permit in the bus.

Note 2: if you want to change the station address after data exchange had in proceed, you must be let the PROFI-8455's Watchdog timeout and wait for 1 sec to release old address.

---

## 2.8. Baud rate support

PROFI-8455 supports the entire baud rates of PROFIBUS. They are 9.6Kbps, 19.2Kbps, 45.45Kbps, 187.5Kbps, 500Kbps, 1.5Mbps, 3Mbps, 6Mbps, and 12Mbps. Because PROFI-8455 has a functionality of auto-detection for baud rates, users don't need to set the baud rate of PROFI-8455.

Note: Many baud rates only are supported by the particular cable or speed. For the detail, please refer to the above section “**PROFIBUS Cable and Transmission Distance**”



---

### 3. PROFIBUS DP System

#### 3.1. The flow chart of the DP-slave

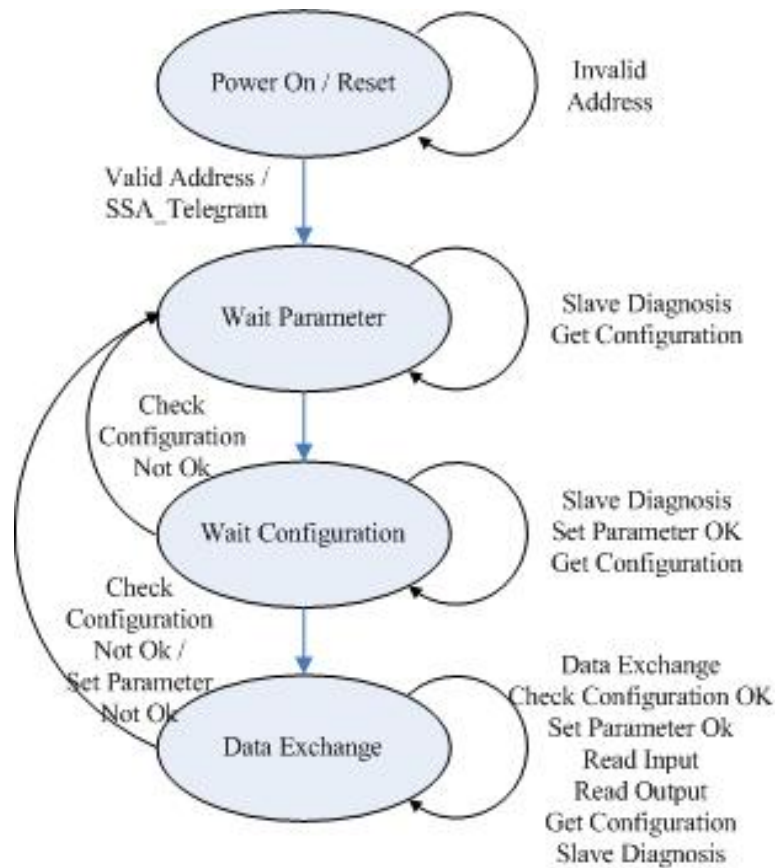

Before DP-Slave changes to data exchange state, it employs some telegrams to initialize and establish the connection with DP-Master. These telegrams include Slave Diagnosis (Slave\_Diag), Set Parameter (Set\_Prm), Check Configuration (Chk\_Cfg), Slave Diagnosis, Data Exchange (Data\_Exch) and optional global control (GC). The explanation is as follows:

### 3.2. Power On / Reset – Rotary switch

While the power of PROFI-8455 has been supplied, PROFI-8455 loads the value of rotary switch first and decides to apply it or not by according to mechanism as follows. If the address of rotary switch is smaller than 126, PROFI-8455 applies the value directly. PROFI-8455 will load the pre-saved address stored in EEPROM, if the address of rotary switch is larger than 126 and smaller than 255. If the address stored in EEPROM is equal to 126 again, PROFI-8455 will wait for the Set\_Slave\_Add(SSA) telegram. A special address 255 is used for recovering address 126 to EEPROM in case of error SSA\_telegram setting or other cases. Please refer to the more detail in the next chapter. The following figure shows the state flow of Wait SSA.

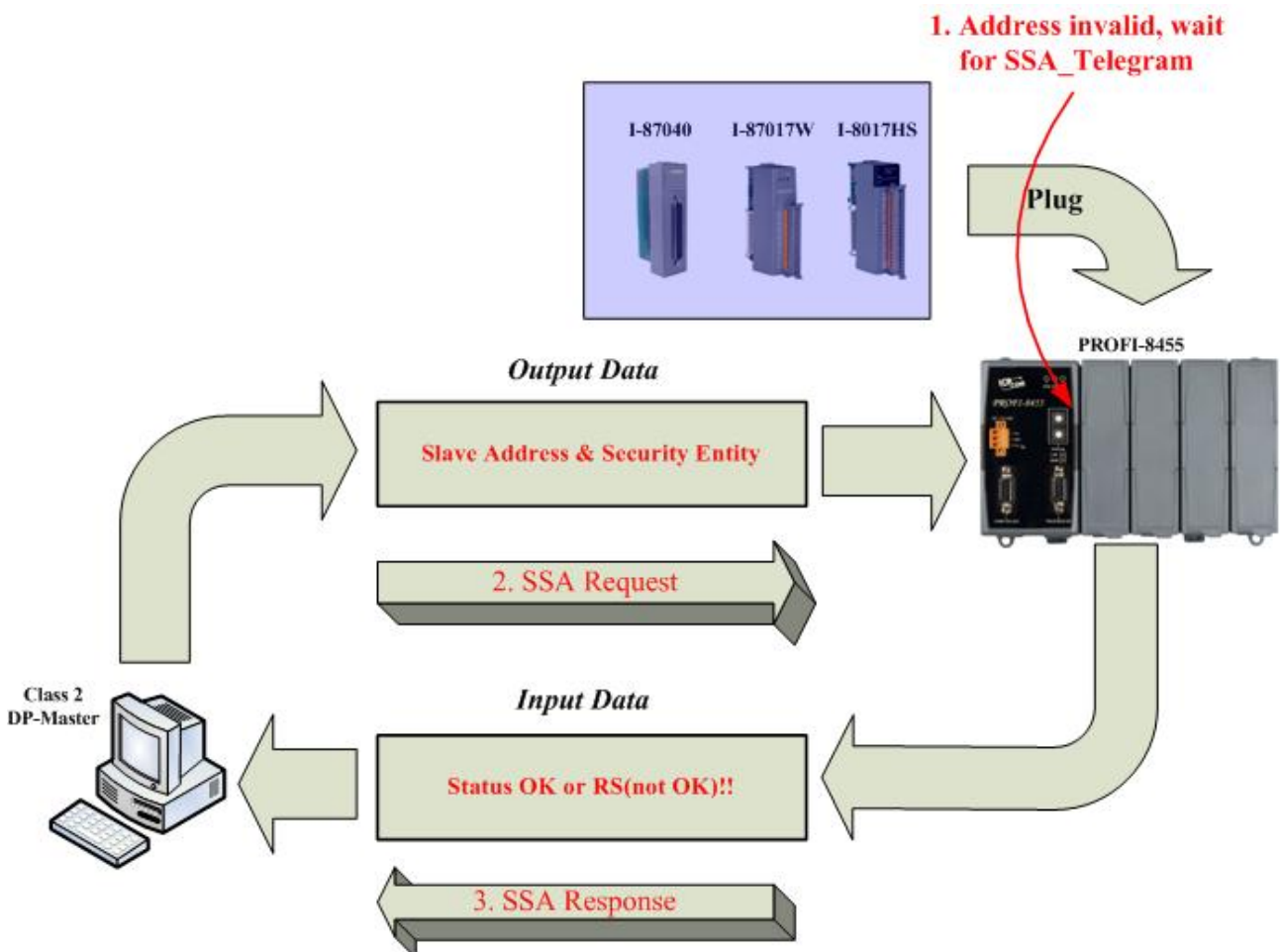

---

### 3.3. Parameterization Data

In order to establish the connection completely, the DP-Slave should obtain enough information from the DP-Master. The DP-Slave uses the parameterization data to initialize the I/O module of DP-Slave. Parameters provided by DP-master divided into two parts in general: one is master-related parameter, and the other is module-related parameter. Master-related parameters provide the common setting between DP-Master and DP-Slave (e.g. Byte-Order, Diagnostic Period, etc). Module-related parameters provide the fundamental setting of the I/O modules in DP-Slave. If the parameters have been set in the DP-Slave successfully, DP-state will proceed to wait configuration, otherwise it will return to wait parameter.

PROFI-8455 also has two kinds of parameter data. One kind of parameters is the system data, and the other is I/O module data. In i-8K modules, there is no I/O module parameter except for i-8017H(S), i-8024, i-8050 and i-8080. In i-87K modules, every module has their own parameters to determine the data format and operation mode. We will describe the I/O modules plugged in PROFI-8455 individually in next section.

#### System parameters

##### 1. Byte-Order

The memory allocation in PROFI-8455 is according to the slot id. Therefore, the I/O module in slot 0 will allocate memory first, slot 1 in next and so on. Byte order is an important factor related to the memory allocation. Big-endian byte order (Motorola format) allocates more significant byte in lower memory address. On the other hand, little-endian Byte order (Intel format) allocates more significant byte in higher memory address.

For example, the integer which value is 0x0400(hex) will allocates 0x40(hex) in the first byte of the memory allocated to the integer and 0x00(hex) in the second byte.

##### 2. Diagnosis Report Period

Slave Diagnosis is one of the function of DP-V0. It reports the unusual event (short-circuit, offline, lower than min. value, larger than max. value and etc.) periodically or immediately. PROFI-8455 will report and retain the last valid value when the I/O modules occur errors. Diagnostic request have no SAP (Service Access Point). The way is using the data exchange telegram or read\_input telegram with a high priority function code. And

---

DP-Master can use the slave\_diag telegram to fetch diagnostic message before the next data exchange request. Then the data exchange continues.

As mentioned above, the average period of data exchange will increase when DP-slave sends slave\_diag request to DP-Master continuously. In other words, the system performance will reduce. In order to solve this problem, PROFI-8455 provides a system parameter “diagnosis report period” to pick an appropriate period. This period is flexible and its range is from 0ms to 65535ms (0ms represent immediate report).

## **Module parameters for I-8K module**

### **i-8017H(S)**

i-8017 is a standard analog input module; it requires the data of “Data Format”, “Data Range” and “Diag Enable” to establish the connection completely. In order to reduce the length of parameter data, PROFI-8455 encapsulates this information into one byte for one channel. So there are 8 bytes data for i-8017H and 16 bytes for i-8017HS.

Data range is about the measurement type (voltage, current) and the measurement range (-10v to 10v or 4mA to 20mA). Data format can be selected either engineer unit format or hexadecimal format. Finally, “Diag Enable” is a flag that determines whether diagnostic message will report or not.

### **i-8024:**

i-8024 is similar to i-8017H(S) , please refer to i-8017 .

### **i-8050:**

i-8050 is a programmable digital input/output module with sixteen programmable I/O. It is different from the other digital modules. Before using i-8050, user must configure it first. PROFI-8455 provides a 2-byte length to configure the i-8050. The first byte controls the direction (Input or Output) of channel 15 to channel 8, and the second byte correspond to channel 7 to channel 0. As mentioned above, digit ‘1’ represents input and ‘0’ represents output.

### **i-8080:**

i-8080 is a counter/frequency module with 30 bytes length parameter. PROFI-8455 divides these parameters into 2 parts; First part is only for

---

frequency mode, which is updated period of auto mode, low-frequency mode, and high frequency respectively. Another part is for both Frequency and Counter mode, which is XOR-Register, Channel Mode, Frequency Band, Filter Enabled, and Low Pass Filter Pulse Width respectively. Note that if frequency band is selected inappropriately, it will induce the incorrect measurement. For example, if a input signal is 80Khz and frequency band is set to low frequency band with 1000ms update period, then it will measure 65.536KHz instead of 80KHz. Therefore selecting an appropriate frequency band is necessary. For the detail, please refer to i-8080 user manual. In additional, PROFI-8455 provides another parameter that controls the trigger type of count clear. User can choose one of them if needed.

Note: i-8080 hardware counter is 16 bit and maximum counter value is 65535. PROFI-8455 uses the software method to expand this bound to  $2^{48}$ , so user must be careful with some limits.

### **Module Parameter for i-87K module:**

Before using the i-87K module with PROFI-8455, it must be initialized the configuration. Unlike the i-8K module, i-87K module uses the serial interface to communicate with MCU. In the following section, we will introduce the module parameters of i-87K briefly.

1. Type Code: every operation mode has an unique type code in the i-87K module. Its range is from 0 to 128. This code dominates the module's behaviors which are voltage input, current input, temperature input, digital I/O and so on. In general, most AI modules support parts of type code. For example, i-87017 supports type code 0x08 to 0x0D for voltage input.
2. Data Format: PROFI-8455 provides four kinds of data format to broaden the applicability. They are engineer unit format, Hexadecimal format, percentage of full scale and Ohm in engineer unit. Most i-87K modules support the first three formats, and the last format is only supported by i-87013 and i-87015.

Besides the essential parameter mentioned above, a number of modules have some self-related parameter.

---

**Analog Module**, e.g. i-87013, i-87015, i-87017, i-87017R, i-87017RC, i-87017ML, i-87018, i-87018R, i-87018Z, i-87019R, i-87022, i-87024 and i-87026, they all have an additional parameter “Diag Enable” to determine whether diagnosis report or not.

Among the analog input modules, most of them share a common type code. It means that every channel operates at the same mode, and this manner will narrow its applicability. ICP DAS provides a number of modules supporting individual channel configuration to solve this problem; They are i-87015 and i-87019R. In contrast to analog input module, analog output modules i-87022 and i-87026 also support individual channel configuration.

In **Counter/Frequency module** i-87082, type-code is fixed to 0x80, and its parameters are divided into several parts, as shown below:

1. **Frequency Gate Time:** Frequency gate time is also called “sampling period”. It controls the signal-passing time. The counter takes effect during this period only, when AC-signal is supplied. After this period has elapsed, PROFI-8455 transforms this count into appropriate count value or frequency value immediately and available in INPUT buffer.
2. **High Level Trigger Voltage:** It is the threshold of the minimum input voltage of logic “1” at the non-isolated input. The default value is 24(2.4 volt).
3. **Gate Mode:** Gate mode is like frequency gate time. The difference between them is that gate mode is for counter mode and frequency gate time is for frequency mode. Gate mode with 0 is low active which means the count-signal take into account if GATE pin is connected a logic “0”. Gate mode with 1 is like Gate mode with 0, but the mode is high active. Gate mode with 2 disables gate control and GATE pin is regardless.
4. **Low Level Trigger Voltage:** It is the threshold of the maximum input voltage of logic “0” at the non-isolated input. The default value is 8(0.8 volt).

- 
5. Input Mode: This parameter is used to define the input as isolated or non-isolated. The Isolated input is used to isolate the electrical interference. The Isolated input uses photo-couple to pass the On/Off signal to i-87082 and the non-isolated input is directly accepted the input signal into the i-87082.
  6. Filter Enabled: Digital filter is provided by i-87082, and it can be enabled by setting this parameter to “Enable”.
  7. Trigger Type of Channel 1 & 0: Trigger type is a parameter that control the action of “Clear”, “Start”, “Stop” command. The default setting is Rising Edge Trigger. i-87082 can accept command only when the state of the function selection is changed from 0(Disable) to 1(Start) or 2(Stop) or 3(Clear). On the other hand, i-87082 accepts command only with the value of the function selection larger than 0 when the setting is High Level Trigger,.
  8. High Level Pulse Width: This parameter is an important factor of digital filter. It dominates the minimum pulse width that i-87082 can accept. If pulse width is shorter than that, it will be filtered. Otherwise, it can pass through. For example, if there is a signal 200 KHz with duty cycle 50% and high level pulse width is set to 3us, then this measurement signal is limited in 166 KHz. The Signal has been filtered, because the signal with 200 KHz has the pulse width of 2.5us and it is smaller than 3us.

Note: Formula of Maximum Frequency is equal to the inverse of pulse width divided by duty cycle.

9. Low Level Pulse Width: This parameter is like High Level Pulse width. Please refer to High Level Pulse Width.
10. Preset Count of Counter N: The preset count is a parameter with four bytes length. It will be load when clear command is issued or module reset. The range of this parameter is between 0 and  $2^{32}$ . Notice that this setting will not be cleared by clear command. It only can be modified by Set\_Prm telegram.

---

11. Maximum Count of Counter N: Maximum count is the threshold of the overflow. If the count value reaches this threshold, the channel will overflow and halt for clear. Otherwise, the counter continues counting. There is the difference between i-87082 and li-8080. The overflow presentation in i-8080 is an integer with 16 bits length just only one bit in i-87082.

Note: When overflow flag is not cleared by users, it will be held this status until clear command is issued. As soon as the channel overflows, the diagnostic message will be reported.

### **Module Parameter for Output modules:**

The output modules consist of Analog Output modules and Digital Output modules. They are different from the Input modules. Output modules have the Safe Value output mechanism. They can output the Safe Value while PROFI-8455 has been changed to stop mode (or offline mode). The safe value can make sure of the correctness of operating. There are three modes in safe value for users: Retain Last Value, Clear Output and Switch to Substitute Value.

Retain Last Value is that PROFI-8455 retain the last valid output value for the corresponding channel.

Clear Output clear the corresponding channel to analog zero volt, analog zero ampere or digit logic "0".

Substitute Value follows Safe mode selection in module parameter, it is setting by user, it must be obey the data range of corresponding data format and type-code.

The following figure shows the state flow of Wait Parameter.



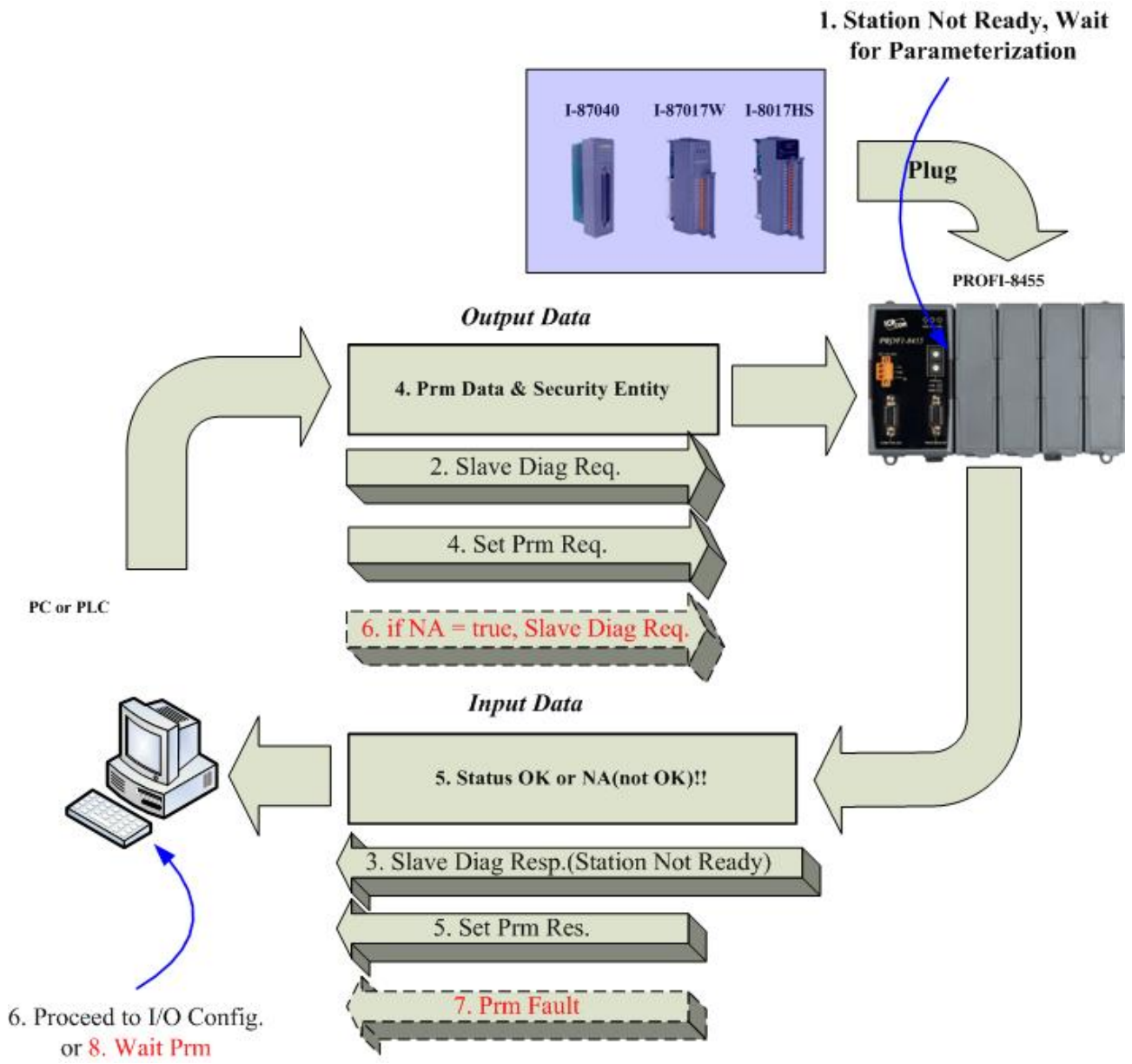

---

### 3.4. Wait Configuration

Configuration data is consisting of module-identifier. The main purpose is to check the configuration data from DP-Master against the stored one in PROFI-8455. If these configuration data is coincident between PROFI-8455 and DP-master, the DP-mode of PROFI-8455 will proceed from wait configuration to data exchange. Otherwise, PROFI-8455 will report “Cfg Fault” and change DP-mode to wait parameter again.

#### Configuration Data

The configuration data specifies the number of input and output bytes of PROFI-8455. PROFI-8455 applies this information to allocate appropriate number of memory space for the module plugged in I/O expansion slot on PROFI-8455. The maximum number of Input and output byte are 128 bytes each. It is not permitted to exceed this quantity. The following table shows the module name and corresponding input byte, output byte and configuration code.

Module name	Input Length	Output Length	Cfg Code
i-8017HS – S <sup>1</sup>	16 Byte(8*2)	0	0x57
i-8017H(S) – D <sup>2</sup>	32 Byte(16*2)	0	0x5F
i-8024	0	8 Byte	0x63
i-8037	0	2 Byte	0x21
i-8040	4 Byte	0	0x13
i-8041	0	4 Byte	0x23
i-8042	2 Byte	2 Byte	0x31
i-8050	2 Byte	2 Byte	0x31
i-8051	2 Byte	0	0x11
i-8052	1 Byte	0	0x10
i-8053	2 Byte	0	0x11
i-8054	1 Byte	1 Byte	0x30
i-8055	1 Byte	1 Byte	0x30
i-8056	0 Byte	2 Byte	0x21
i-8057	0 Byte	2 Byte	0x21
i-8058	1 Byte	0	0x10
i-8060	0	1 Byte	0x20

i-8063	1 Byte	1 Byte	0x30
i-8064	0	1 Byte	0x20
i-8065	0	1 Byte	0x20
i-8066	0	1 Byte	0x20
i-8068	0	1 Byte	0x20
i-8069	0	1 Byte	0x20
i-8077	1 Byte	1 Byte	0x20
i-8080	48Byte(8*6)	1 Byte	0xC0,0x00,0x2F
i-87013	8 Byte(4*2)	0	0x53
i-87015	14 Byte(7*2)	0	0x56
i-87017(R)	16 Byte(8*2)	0	0x57
i-87017RC	16 Byte(8*2)	0	0x57
i-87017ML	16 Byte(8*2)	0	0x57
i-87018(R)	16 Byte(8*2)	0	0x57
i-87018(R) (w/ CJC Read/Offset)	18 Byte(8*2+2 <sup>@1</sup> )	2 Byte(0+2 <sup>@2</sup> )	0x57,0xC0,0x01, 0x40
i-87018Z	20 Byte(10*2)	0	0x59
i-87018Z (w/ CJC Read/Offset)	22 Byte (10*2+2 <sup>@1</sup> )	3 Byte(0+3 <sup>@2</sup> )	0x59,0xC0,0x02, 0x40
i-87019R	16 Byte(8*2)	0	0x57
i-87019R (w/ CJC Read/Offset)	18 Byte(8*2+2 <sup>@1</sup> )	3 Byte(0+3 <sup>@2</sup> )	0x57,0xC0,0x02, 0x40
i-87022	0	4 Byte(2*2)	0x61
i-87024	0	8 Byte(4*2)	0x63
i-87026	0	4 Byte(2*2)	0x61
i-87040(W)	4 Byte	0	0x13
i-87040(W)(w/ Cnt)	68 Byte(4+32*2)	5 Byte(0+4)	0x13,0xC0,0x03, 0x5F
i-87041(W)	0	4 Byte	0x23
i-87046W	2 Byte	0	0x11
i-87046W(w/ Cnt)	34 Byte(2+16*2)	2Byte(0+2)	0x11,0xC0,0x01, 0x4F
i-87051(W)	2 Byte	0	0x11
i-87051(W)(w/ Cnt)	34 Byte(2+16*2)	2 Byte(0+2)	0x11,0xC0,0x01, 0x4F
i-87052(W)	1 Byte	0	0x10
i-87052(W)(w/ Cnt)	17 Byte(1+8*2)	1 Byte(0+1)	0x10,0xC0,0x00, 0x47

i-87053(W)	2 Byte	0	0x11
i-87053(W)(w/ Cnt)	34 Byte(2+16*2)	2 Byte(0+2)	0x11,0xC0,0x01, 0x4F
i-87054(W)	1 Byte	1 Byte	0x30
i-87054(W)(w/ Cnt)	17 Byte(1+8*2)	2 Byte(1+1)	0x30,0xC0,0x00, 0x47
i-87055(W)	1 Byte	1 Byte	0x30
i-87055(W)(w/ Cnt)	17 Byte(1+8*2)	2 Byte(1+1)	0x30,0xC0,0x00, 0x47
i-87057(W)	0	2 Byte	0x21
i-87058(W)	1 Byte	0	0x10
i-87058(W)(w/ Cnt)	17 Byte(1+8*2)	1 Byte(0+1)	0x10,0xC0,0x00, 0x47
i-87063(W)	1 Byte	1 Byte	0x30
i-87063(w/ Cnt)	9 Byte(1+4*2)	2 Byte(1+1)	0x30,0xC0,0x00, 0x43
i-87064(W)	0	1 Byte	0x20
i-87065(W)	0	1 Byte	0x20
i-87066(W)	0	1 Byte	0x20
i-87068(W)	0	1 Byte	0x20
i-87069(W)	0	1 Byte	0x20
i-87082	9 Byte	1 Byte(1 OR 1)	0x53,0x10,0x20

-S<sup>1</sup> means single-end input mode

-D<sup>2</sup> means differential input mode

- Data length of analog input module = channel number \* data length per channel.

-Data length of digital input module = the length of basic input data + channel number \* data length of counter per channel.

-Data length of digital output module = the length of basic output data + optional data length of clear command.

-OR means DO data have combined with Clear command into one byte.

-@<sup>1</sup> means the data length of CJC temperature.

-@<sup>2</sup> means the data length of CJC offset setting command.

The figure is shown below the state flow of Wait Configuration.

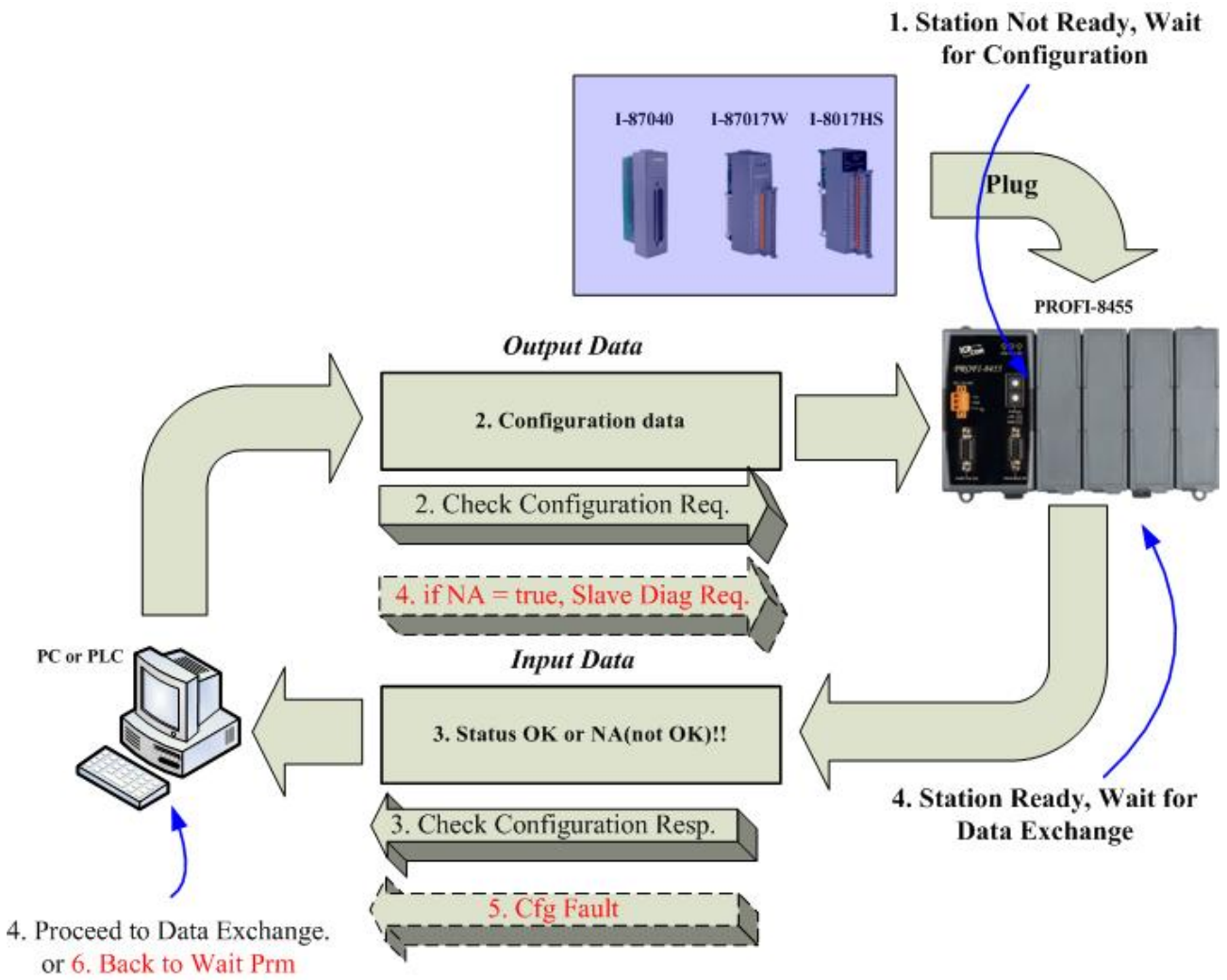

---

### 3.5. Data Exchange

After the parameterization and configuration processes have been accomplished, PROFI-8455 exchanges I/O data with the DP-Master cyclically. In following section, we introduce the Numeric Notation and Byte Order briefly.

#### 3.5.1 Numeric Representation

Among Analog Input modules or Analog Output modules, there are many numeric representations, include Engineer-Unit, Hexadecimal, Percentage of Full Scale and Ohm in Engineer-Unit. We will introduce the numeric representation in i-8K module and i-87K module.

##### **i-8K Series**

Analog Input Module ( i-8017H, i-8017HS)

+/- 10 V :

The range for Engineer-Unit: -10000~10000(mV)

The range for 2's complement hexadecimal: 0000~1FFF (0v ~ 10v),  
2000~3FFF (-10v~1.22mV)

Conversion from Engineer-Unit to 2's complement hexadecimal:

$$HexValue = \frac{EngineerValue}{10000} \times 8192 - 1 \quad \text{if } 0 \leq EngineerValue \leq 10000$$

$$HexValue = \frac{EngineerValue}{10000} \times 8192 + 16384 \quad \text{if } -10000 \leq EngineerValue < 0$$

Measurement Value	Decimal	Hexadecimal
+10v(Engineer mode)	10000	0x2710
0v(Engineer mode)	0	0x0000
-10v(Engineer mode)	-10000	0xD8F0
+10v(Hex mode)	8191	0x1FFF
+5v(Hex mode)	4095	0x1000
0v(Hex mode)	0	0x0000
-5v(Hex Mode)	12288	0x3000
-10v(Hex mode)	8192	0x2000

---

+/- 5 V :

The range for Engineer-Unit: -5000~5000(mV)

The range for 2's complement hexadecimal: 0000~1FFF (0v ~ 5v),  
2000~3FFF (-5v~0.61mV)

Conversion from Engineer-Unit to 2's complement hexadecimal:

$$\text{HexValue} = \frac{\text{EngineerValue}}{5000} \times 8192 - 1 \quad \text{if } 0 \leq \text{EngineerValue} \leq 5000$$

$$\text{HexValue} = \frac{\text{EngineerValue}}{5000} \times 8192 + 16384 \quad \text{if } -5000 \leq \text{EngineerValue} < 0$$

Measurement Value	Decimal	Hexadecimal
+5v(Engineer mode)	5000	0x1388
0v(Engineer mode)	0	0x0000
-5v(Engineer mode)	-5000	0xEC78
+5v(Hex mode)	8191	0x1FFF
+2.5v(Hex mode)	4095	0x1000
0v(Hex mode)	0	0x0000
-2.5v(Hex mode)	12288	0x3000
-5v(Hex Mode)	8192	0x2000

+/- 2.5 V :

The range for Engineer-Unit: -2500~2500(mV)

The range for 2's complement hexadecimal: 0000~1FFF (0v ~ 2.5v),  
2000~3FFF (-2.5v~0.3mV)

Conversion from Engineer-Unit to 2's complement hexadecimal:

$$\text{HexValue} = \frac{\text{EngineerValue}}{2500} \times 8192 - 1 \quad \text{if } 0 \leq \text{EngineerValue} \leq 2500$$

$$\text{HexValue} = \frac{\text{EngineerValue}}{2500} \times 8192 + 16384 \quad \text{if } -2500 \leq \text{EngineerValue} < 0$$

Measurement Value	Decimal	Hexadecimal
+2.5v(Engineer mode)	2500	0x09C4
0v(Engineer mode)	0	0x0000
-2.5v(Engineer mode)	-2500	0xF63C
+2.5v(Hex mode)	8191	0x1FFF
+1.25v(Hex mode)	4095	0x1000
0v(Hex mode)	0	0x0000
-1.25v(Hex mode)	12288	0x3000
-2.5v(Hex Mode)	8192	0x2000

---

+/- 1.25 V :

The range for Engineer-Unit: -1250~1250(mV)

The range for 2's complement hexadecimal: 0000~1FFF (0v ~ 1.25v),  
2000~3FFF (-1.25v~0.15mV)

Conversion from Engineer-Unit to 2's complement hexadecimal:

$$\text{HexValue} = \frac{\text{EngineerValue}}{1250} \times 8192 - 1 \quad \text{if } 0 \leq \text{EngineerValue} \leq 1250$$

$$\text{HexValue} = \frac{\text{EngineerValue}}{1250} \times 8192 + 16384 \quad \text{if } -1250 \leq \text{EngineerValue} < 0$$

Measurement Value	Decimal	Hexadecimal
+1.25v(Engineer mode)	1250	0x04E2
0v(Engineer mode)	0	0x0000
-1.25v(Engineer mode)	-1250	0xFB1E
+1.25v(Hex mode)	8191	0x1FFF
+0.675v(Hex mode)	4095	0x1000
0v(Hex mode)	0	0x0000
-0.675v(Hex mode)	12288	0x3000
-1.25v(Hex Mode)	8192	0x2000

+/- 20 mA :

The range for Engineer-Unit: -20000~20000(mV)

The range for 2's complement hexadecimal: 0000~1FFF (0mA ~  
20mA), 2000~3FFF (-20mA ~ -2.44uA)

Conversion from Engineer-Unit to 2's complement hexadecimal:

$$\text{HexValue} = \frac{\text{EngineerValue}}{20000} \times 8192 - 1 \quad \text{if } 0 \leq \text{EngineerValue} \leq 20000$$

$$\text{HexValue} = \frac{\text{EngineerValue}}{20000} \times 8192 + 16384 \quad \text{if } -20000 \leq \text{EngineerValue} < 0$$

Measurement Value	Decimal	Hexadecimal
20mA(Engineer mode)	20000	0x4E20
10mA(Engineer mode)	10000	0x2710
0v(Engineer mode)	0	0x0000
20mA(Hex mode)	8191	0x1FFF
10mA(Hex mode)	4095	0x1000
0v(Hex mode)	0	0x0000



---

Analog output module ( I-8024) :

+/- 10 V :

The range for Engineer-Unit: -10000~10000(mV)

The range for 2's complement hexadecimal: 0000~7FFF (0v ~ 10v),  
8000~FFFF (-10v~0.3mV)

Conversion from Engineer-Unit to two's complement hexadecimal:

$$HexValue = \frac{EngineerValue}{10000} \times 32768 - 1 \quad \text{if } 0 \leq EngineerValue \leq 10000$$

$$HexValue = \frac{EngineerValue}{10000} \times 32768 + 65536 \quad \text{if } -10000 \leq EngineerValue < 0$$

Measurement Value	Decimal	Hexadecimal
10v(Engineer mode)	10000	0x2710
0v(Engineer mode)	0	0x0000
-10v(Engineer mode)	-10000	0xD8F0
10v(Hex mode)	32767	0x7FFF
0v(Hex mode)	0	0x1000
-10v(Hex mode)	-32768	0x8000

+ 20mA :

The range for Engineer-Unit: -20000~20000(mV)

The range for 2's complement hexadecimal: 0000~7FFF (0v ~ +20mA)

Conversion from Engineer-Unit to 2's complement hexadecimal:

$$HexValue = \frac{EngineerValue}{20000} \times 32768 - 1$$

Measurement Value	Decimal	Hexadecimal
20mA(Engineer mode)	20000	0x4E20
0mA(Engineer mode)	0	0x0000
20mA(Hex mode)	32767	0x7FFF
0mA(Hex mode)	0	0x0000

## i-87K Module

i-87K modules are serial communication-based I/O modules, they provide various data formats. For example, Engineer-Unit, Percentage of Full Scale, 2's Complement Hexadecimal and Ohm format are supported in these modules. The relationship between the type of measurement and the unit of measurement is represented in the following table.

Type	Conditions	Unit
Voltage/Current	$-10V \leq \text{Voltage} \leq 10V$ $20mA \geq \text{Current} \geq -20mA$	milli-Volt(mV) micro-Ampere( $\mu A$ )
Voltage	$\text{Voltage} \geq 10V$ or $\text{Voltage} \leq -10V$	Volt(V)
Temperature	RTD/Pt/Ni/Cu-RTD/Thermocouple	0.1 Degree Celsius
Resistor	RTD/Pt/Ni/Cu-RTD/Thermocouple	0.1 Ohm(0.1 $\Omega$ )

### i-87013 and i-87015 Analog Input Module

Type-Code	Input Range	Data Format	Max.	Min
20	Pt-100 (a = 0.00385) -100°C to 100°C	Engineer Unit	+1000	-1000
		% of FSR	+10000	-10000
		2's complement HEX	7FFF	8000
		Ohm	+1385	+0602
21	Pt-100 (a = 0.00385) 0°C to 100°C	Engineer Unit	+1000	+0000
		% of FSR	+10000	+00000
		2's complement HEX	7FFF	0000
		Ohm	+1385	+1000
22	Pt-100 (a = 0.00385) 0°C to 200°C	Engineer Unit	+2000	+0000
		% of FSR	+10000	+00000
		2's complement HEX	7FFF	0000
		Ohm	+1758	+1000
23	Pt-100 (a = 0.00385) 0°C to 600°C	Engineer Unit	+6000	+0000
		% of FSR	+10000	+00000
		2's complement HEX	7FFF	0000
		Ohm	+3135	+1000
24	Pt-100 (a = 0.003916) -100°C to 100°C	Engineer Unit	+1000	-1000
		% of FSR	+10000	-10000
		2's complement HEX	7FFF	8000
		Ohm	+1391	+0595

25	Pt-100 (a = 0.003916) 0°C to 100°C	Engineer Unit	+1000	+0000
		% of FSR	+10000	+00000
		2's complement HEX	7FFF	0000
		Ohm	+1391	+1000
26	Pt-100 (a = 0.003916) 0°C to 200°C	Engineer Unit	+2000	+0000
		% of FSR	+10000	+00000
		2's complement HEX	7FFF	0000
		Ohm	+1771	+1000
27	Pt-100 (a = 0.003916) 0°C to 600°C	Engineer Unit	+6000	+0000
		% of FSR	+10000	+00000
		2's complement HEX	7FFF	0000
		Ohm	+3172	+1000
28	Nickel 120 -80°C to 100 °C	Engineer Unit	+1000	-0800
		% of FSR	+10000	-08000
		2's complement HEX	7FFF	999A
		Ohm	+2006	+1206
29	Nickel 120 0°C to 100°C	Engineer Unit	+1000	+0000
		% of FSR	+10000	+00000
		2's complement HEX	7FFF	0000
		Ohm	+2006	+1206
2A	Pt-1000(a = 0.00385) -200°C to 600°C	Engineer Unit	+6000	-2000
		% of FSR	+10000	-03333
		2's complement HEX	7FFF	D556
		Ohm	+31371	+01852
2B <sup>*1</sup>	Cu 100 (a = 0.00421) -20°C to 150°C	Engineer Unit	+1500	-0200
		% of FSR	+10000	-01333
		2's complement HEX	7FFF	EEEE
		Ohm	+1631	+0915
2C <sup>*1</sup>	Cu 100 a = 0.00421 0°C to 200°C	Engineer Unit	+2000	0000
		% of FSR	+10000	-00000
		2's complement HEX	7FFF	0000
		Ohm	+1677	+0903
2D <sup>*1</sup>	Cu 1000 a = 0.00421 -20°C to 150°C	Engineer Unit	+1500	-0200
		% of FSR	+10000	-01333
		2's complement HEX	7FFF	EEEE
		Ohm	+16317	+09156
2E <sup>*2</sup>	Pt 100 a = 0.00385 -200°C to +200°C	Engineer Unit	+2000	-2000
		% of FSR	+10000	-10000

		2's complement HEX	7FFF	8000
		Ohm	+1758	+0184
2F <sup>*2</sup>	Pt 100 a = 0.003916 -200°C to +200°C	Engineer Unit	+2000	-2000
		% of FSR	+10000	-10000
		2's complement HEX	7FFF	8000
		Ohm	+1771	+0171
80 <sup>*2</sup>	Pt 100 a = 0.00385 -200°C to +600°C	Engineer Unit	+6000	-2000
		% of FSR	+10000	-03333
		2's complement HEX	7FFF	D556
		Ohm	+3135	+0184
81 <sup>*2</sup>	Pt 100 a = 0.003916 -200°C to +600°C	Engineer Unit	+6000	-2000
		% of FSR	+10000	-03333
		2's complement HEX	7FFF	D556
		Ohm	+3172	+0171

\* 1: Type 2B, 2C and 2D are only available with i-87015.

\* 2: Type 2E, 2F, 80 and 81 are only available with the i-87015 firmware version A1.10 and later, i-87013 firmware version B1.3 and later.

#### **i-87017/i-87017R Analog Input Module**

Type-Code	Input Range	Data Format	Max.	Min
08	-10V to +10V	Engineer Unit	+10000	-10000
		% of FSR	+10000	-10000
		2's Complement HEX	7FFF	8000
09	-5V to +5V	Engineer Unit	+50000	-50000
		% of FSR	+10000	-10000
		2's Complement HEX	7FFF	8000
0A	-1V to +1V	Engineer Unit	+10000	-10000
		% of FSR	+10000	-10000
		2's Complement HEX	7FFF	8000
0B	-500mV to +500mV	Engineer Unit	+500	-500
		% of FSR	+10000	-10000
		2's Complement HEX	7FFF	8000
0C	-150mV to +150mV	Engineer Unit	+150	-150
		% of FSR	+10000	-10000
		2's Complement HEX	7FFF	8000
0D	-20mA to +20mA	Engineer Unit	+20000	-20000

		% of FSR	+10000	-10000
		2's Complement HEX	7FFF	8000

### **i-87017RC** Analog Input Module

Type-Code	Input Range	Data Format	Max.	Min
07	-4mA to +20mA	Engineer Unit	+04000	+20000
		% of FSR	+10000	-10000
		2's Complement HEX	7FFF	8000
0D	-20mA to +20mA	Engineer Unit	+20000	-20000
		% of FSR	+10000	-10000
		2's Complement HEX	7FFF	8000
1A	+0A to +20mA	Engineer Unit	+00000	+20000
		% of FSR	+10000	-10000
		2's Complement HEX	7FFF	8000

### **i-87017ML** Analog Input Module

Type-Code	Input Range	Data Format	Max.	Min
1B	-150V to +150V	Engineer Unit	+150	-150
		% of FSR	+10000	-10000
		2's Complement HEX	7FFF	8000
1C	-50V to +50V	Engineer Unit	+50	-50
		% of FSR	+10000	-10000
		2's Complement HEX	7FFF	8000

### **i-87018/i-87018R** Analog Input Module

Type-Code	Input Range	Data Format	Max.	Min
00	-15mV to +15mV	Engineer Unit	+15	-15
		% of FSR	+10000	-10000
		2's Complement HEX	7FFF	8000
01	-50mV to +50mV	Engineer Unit	+50	-50
		% of FSR	+10000	-10000
		2's Complement HEX	7FFF	8000
02	-100mV to +100mV	Engineer Unit	+100	-100
		% of FSR	+10000	-10000
		2's Complement HEX	7FFF	8000
03	-500mV to +500mV	Engineer Unit	+500	-500

		% of FSR	+10000	-10000
		2's Complement HEX	7FFF	8000
04	-1V to +1V	Engineer Unit	+10000	-10000
		% of FSR	+10000	-10000
		2's Complement HEX	7FFF	8000
05	-25V to +25V	Engineer Unit	+25000	-25000
		% of FSR	+10000	-10000
		2's Complement HEX	7FFF	8000
06	-20mA to +20mA	Engineer Unit	+20000	-20000
		% of FSR	+10000	-10000
		2's Complement HEX	7FFF	8000
0E	J Type	Engineer Unit	+7600	-2100
		% of FSR	+10000	-02763
		2's Complement HEX	7FFF	DCA2
0F	K Type	Engineer Unit	+13720	-02700
		% of FSR	+10000	-01968
		2's Complement HEX	7FFF	E6D0
10	T Type	Engineer Unit	+4000	-2700
		% of FSR	+10000	-06750
		2's Complement HEX	7FFF	A99A
11	E Type	Engineer Unit	+10000	-02700
		% of FSR	+10000	-02700
		2's Complement HEX	7FFF	DD71
12	R Type	Engineer Unit	+17680	+00000
		% of FSR	+10000	+00000
		2's Complement HEX	7FFF	0000
13	S Type	Engineer Unit	+17680	+00000
		% of FSR	+10000	+00000
		2's Complement HEX	7FFF	0000
14	B Type	Engineer Unit	+18200	+00000
		% of FSR	+10000	+00000
		2's Complement HEX	7FFF	0000
15	N Type	Engineer Unit	+13000	-02700
		% of FSR	+10000	-02077
		2's Complement HEX	7FFF	E56B

16	C Type	Engineer Unit	+23200	+00000
		% of FSR	+10000	+00000
		2's Complement HEX	7FFF	0000
17	L Type	Engineer Unit	+8000	-2000
		% of FSR	+10000	-02500
		2's Complement HEX	7FFF	E000
18	M Type	Engineer Unit	+1000	-2000
		% of FSR	+05000	-10000
		2's Complement HEX	4000	8000
19	L Type DIN43710	Engineer Unit	+9000	-2000
		% of FSR	+10000	-02222
		2's Complement HEX	7FFF	E38F

### **i-87019R** Analog Input Module

Type-Code	Input Range	Data Format	Max.	Min
00	-15mV to +15mV	Engineer Unit	+15	-15
		% of FSR	+10000	-10000
		2's Complement HEX	7FFF	8000
01	-50mV to +50mV	Engineer Unit	+50	-50
		% of FSR	+10000	-10000
		2's Complement HEX	7FFF	8000
02	-100mV to +100mV	Engineer Unit	+100	-100
		% of FSR	+10000	-10000
		2's Complement HEX	7FFF	8000
03	-500mV to +500mV	Engineer Unit	+500	-500
		% of FSR	+10000	-10000
		2's Complement HEX	7FFF	8000
04	-1V to +1V	Engineer Unit	+10000	-10000
		% of FSR	+10000	-10000
		2's Complement HEX	7FFF	8000
05	-2.5V to +2.5V	Engineer Unit	+25000	-25000
		% of FSR	+10000	-10000
		2's Complement HEX	7FFF	8000
06	-20mA to +20mA	Engineer Unit	+20000	-20000
		% of FSR	+10000	-10000

		2's Complement HEX	7FFF	8000
08	-10V to +10V	Engineer Unit	+10000	-10000
		% of FSR	+10000	-10000
		2's Complement HEX	7FFF	8000
09	-5V to +5V	Engineer Unit	+50000	-50000
		% of FSR	+10000	-10000
		2's Complement HEX	7FFF	8000
0A	-1V to +1V	Engineer Unit	+10000	-10000
		% of FSR	+10000	-10000
		2's Complement HEX	7FFF	8000
0B	-500mV to +500mV	Engineer Unit	+500	-500
		% of FSR	+10000	-10000
		2's Complement HEX	7FFF	8000
0C	-150mV to +150mV	Engineer Unit	+150	-150
		% of FSR	+10000	-10000
		2's Complement HEX	7FFF	8000
0D	-20mA to +20mA	Engineer Unit	+20000	-20000
		% of FSR	+10000	-10000
		2's Complement HEX	7FFF	8000
0E	J Type	Engineer Unit	+7600	-2100
		% of FSR	+10000	-02763
		2's Complement HEX	7FFF	DCA2
0F	K Type	Engineer Unit	+13720	-02700
		% of FSR	+10000	-01968
		2's Complement HEX	7FFF	E6D0
10	T Type	Engineer Unit	+4000	-2700
		% of FSR	+10000	-06750
		2's Complement HEX	7FFF	A99A
11	E Type	Engineer Unit	+10000	-02700
		% of FSR	+10000	-02700
		2's Complement HEX	7FFF	DD71
12	R Type	Engineer Unit	+17680	+00000
		% of FSR	+10000	+00000
		2's Complement HEX	7FFF	0000
13	S Type	Engineer Unit	+17680	+00000



		% of FSR	+10000	+00000
		2's Complement HEX	7FFF	0000
14	B Type	Engineer Unit	+18200	+00000
		% of FSR	+10000	+00000
		2's Complement HEX	7FFF	0000
15	N Type	Engineer Unit	+13000	-02700
		% of FSR	+10000	-02077
		2's Complement HEX	7FFF	E56B
16	C Type	Engineer Unit	+23200	+00000
		% of FSR	+10000	+00000
		2's Complement HEX	7FFF	0000
17	L Type	Engineer Unit	+8000	-2000
		% of FSR	+10000	-02500
		2's Complement HEX	7FFF	E000
18	M Type	Engineer Unit	+1000	-2000
		% of FSR	+05000	-10000
		2's Complement HEX	4000	8000
19	L Type DIN43710	Engineer Unit	+9000	-2000
		% of FSR	+10000	-02222
		2's Complement HEX	7FFF	E38F

### **i-87022** Analog Output Module

Type-Code	Input Range	Data Format	Max.	Min
0	0mA to 20mA	Engineer Unit	20000	00000
		% of FSR	+10000	+00000
		Hexadecimal	FFF	000
1	4 mA to 20mA	Engineer Unit	20000	04000
		% of FSR	+10000	+00000
		Hexadecimal	FFF	000
2	0V to 10V	Engineer Unit	10000	00000
		% of FSR	+10000	+00000
		Hexadecimal	FFF	000

---

**i-87026** Analog Output Module

Type-Code	Input Range	Data Format	Max.	Min
0	0 mA to 20mA	Engineer Unit	20000	00000
		% of FSR	+10000	+00000
		Hexadecimal	FFFF	0000
1	4 mA to 20mA	Engineer Unit	20000	04000
		% of FSR	+10000	+00000
		Hexadecimal	FFFF	0000
2	0V to 10V	Engineer Unit	10000	00000
		% of FSR	+10000	+00000
		Hexadecimal	FFFF	0000

**i-87024** Analog Output(Only support Engineer Unit)

Type-Code	Input Range	Data Format	Max.	Min
30	0 mA to 20mA	Engineer Unit	+20000	+00000
31	4 mA to 20mA	Engineer Unit	+20000	+04000
32	0V to 10V	Engineer Unit	+10000	+00000
33	-10V to 10V	Engineer Unit	+10000	-10000
34	0V to 5V	Engineer Unit	+05000	+00000
35	-5V to 5V	Engineer Unit	+05000	-05000

### 3.5.2 Byte Order and Data Address

#### i-8K Series & i-87K Series - General Digital Input / Output

The general digital input or output module arrange its data from LSB to MSB in order (i-8040 or i-87040).



#### i-87K Series - Digital Input w/ Counter

The Digital input modules in i-87K series not only provide a basic input function but also have a function of counter which maximum count can be up to 65535. You can choose that in GSD file of PROFI-8455 with the module “i-870XX w/ Counter Func.”. The figure shows below is data arrangement of i-87040 w/ Counter.

#### Data Arrangement of Digital Input w/ Counter: Input Part (Slave->Master)

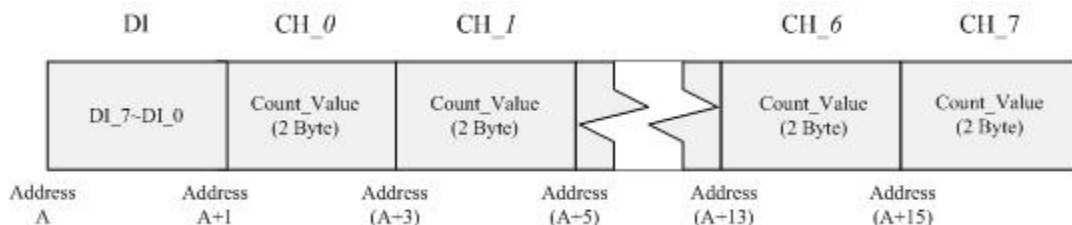

#### Data Arrangement of Digital Input w/ Counter: Output Part (Master->Slave)



Note: DO\_7~DO\_0 is optional, and absence at pure digital input module.

## i-8K Series & i-87K Series – General Analog Input ( w/o CJC Read/Offset ) and Analog Output

Analog module (without CJC function) has the I/O data of 2 byte per channel. For example, the following figure shows data arrangement of i-87024(i-8024).

Note: The order of input or output data is ranked by channel's identifier, so the channel with lower id value has priority over the channel with higher id.

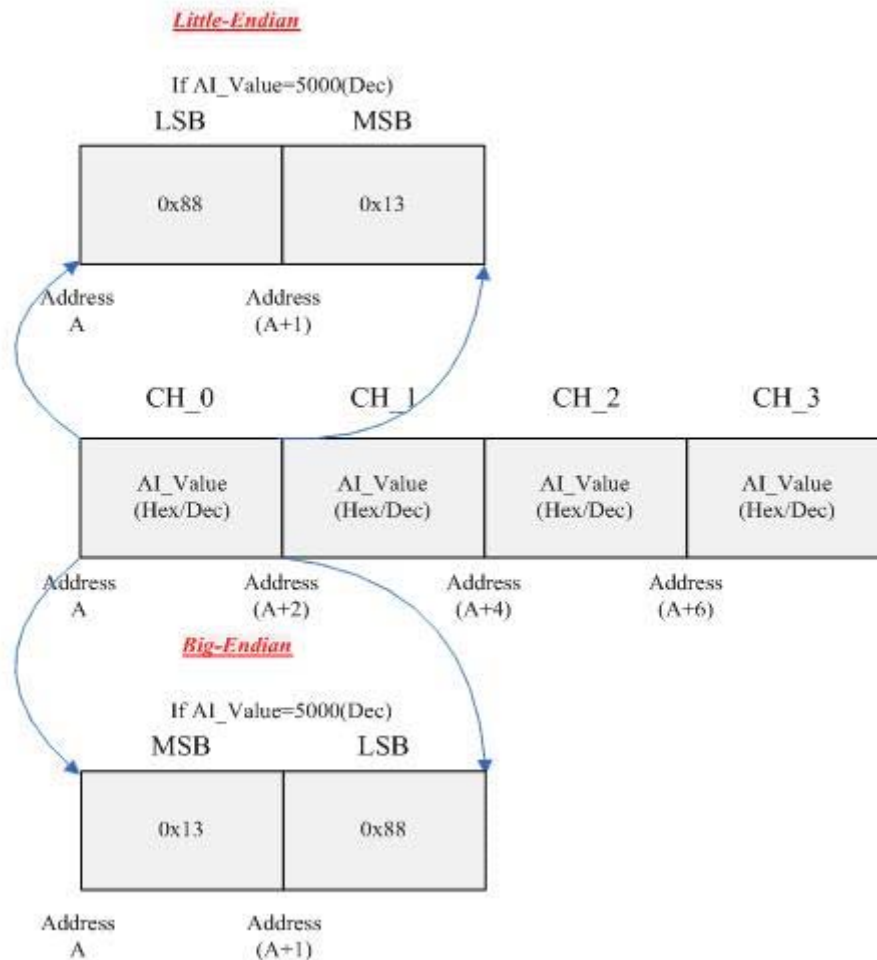

## i-8K Series & i-87K Series – General Analog Input (w/ CJC Read/Offset )

The temperature signal is a kind of analog signals. i-87K modules(i-87013, i-87015, i-87018 and i-87019) provide several solutions to measure the different temperature sensors. Regardless of RTD and thermistor, it is important to note that thermocouples have the following property. The thermocouples measure the temperature difference between hot junction point and cold junction point. But the ordinary thermocouples have no cold-junction point so it can not measure the accuracy temperature using only hot junction

point. In order to solve this problem, i-87K modules which use thermocouple to measure temperature support the Cold Junction Compensation by an internal temperature sensor. Although CJC's problem has been dealt, there is a problem still remained. The problem is that CJC temperature sensor has some varieties compare to practical temperature. Therefore, PROFI-8455 provides an output byte to calibration this difference. The following figure is data arrangement of i-87024 w/ CJC Read/Offset.

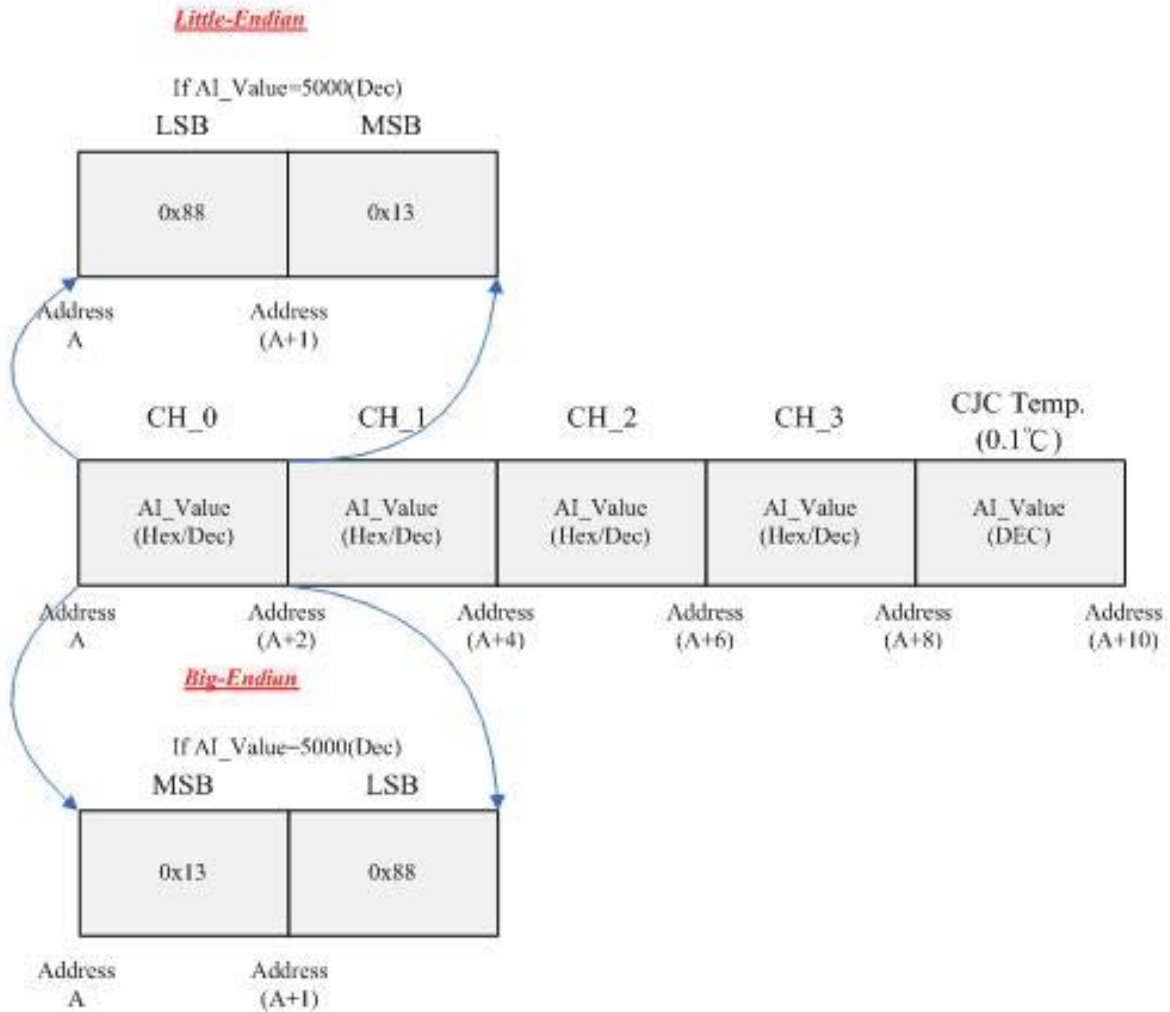

The bytes of CJC offset have a detail description as follows. There are two kinds of data length, 2 bytes and 3 bytes. The data length with 2 byte is used in CJC without individual channel configure and the data length with 3 byte is used in CJC with individual channel configure.

### Bit Arrangement of CJC-Offset using Big-Endian

Bit.	Byte0.3~0	Byte1.7	Byte1.6	Byte1.5	Byte 1.4~Byte2.0
Func.	Chn.Sel.	Ena/Disa	Reserved	Sign	Offset-Value(0.01°C)

### Bit Arrangement of CJC-Offset using Little-Endian

Bit.	Byte2.3~0	Byte1.7	Byte1.6	Byte1.5	Byte 1.4~Byte0.0
Func.	Chn.Sel.	Ena/Disa	Reserved	Sign	Offset-Value

Func.	Meaning	Description
Chn.Sel.(8bits) *	Channel Selection(0~8)	CJC Calibration Channel
Ena/Disa(1bit)	Enable/Disable	CJC Calibration Enable
Reserved(1bit)	Reserved	
Sign(1bit)	Sign (0 -> Pos, 1-> Neg)	Plus or minus offset value to calibration temperature
Offset-Value (13bit)	Offset value	Offset value compare to practice temperature

\*: This field is only available in i-87019R. "Chn.Sel." from 0 to 7 is corresponding to channel 0 to channel 7 and Chn.Sel. 8 is a broadcast channel id that available to all channel.

Note: The maximum value of Offset-Value for i-87019R is 4096 and its unit is 0.01°C; The value for i-87108Z is 127 and its unit is 0.1°C

Note: While Enable/Disable is set ("1"), the calibration works.

Note: The length of output data in i-87018(R/W) is 2 bytes, and 3 bytes for i-87019R and i-87018Z.

### i-8K Series & i-87K Series – Counter/Frequency

i-8080 and i-87082 are counter/frequency module, the differences between them describe in the following table.

Module Name	i-8080	i-87082
Count Range	0~2 <sup>48</sup> (Count+Overflow)	0~2 <sup>32</sup> (Count)
Frequency Range	0~450KHz	0~100KHz
Overflow	0~2 <sup>16</sup>	0~1
Channel Number	8(Up & Freq) or 4(others)	2

The following figure shows the data arrangement of input data. It includes the normal count (4 Bytes) and overflow count (2bytes).

## Data arrangement of input part in i-8080 module

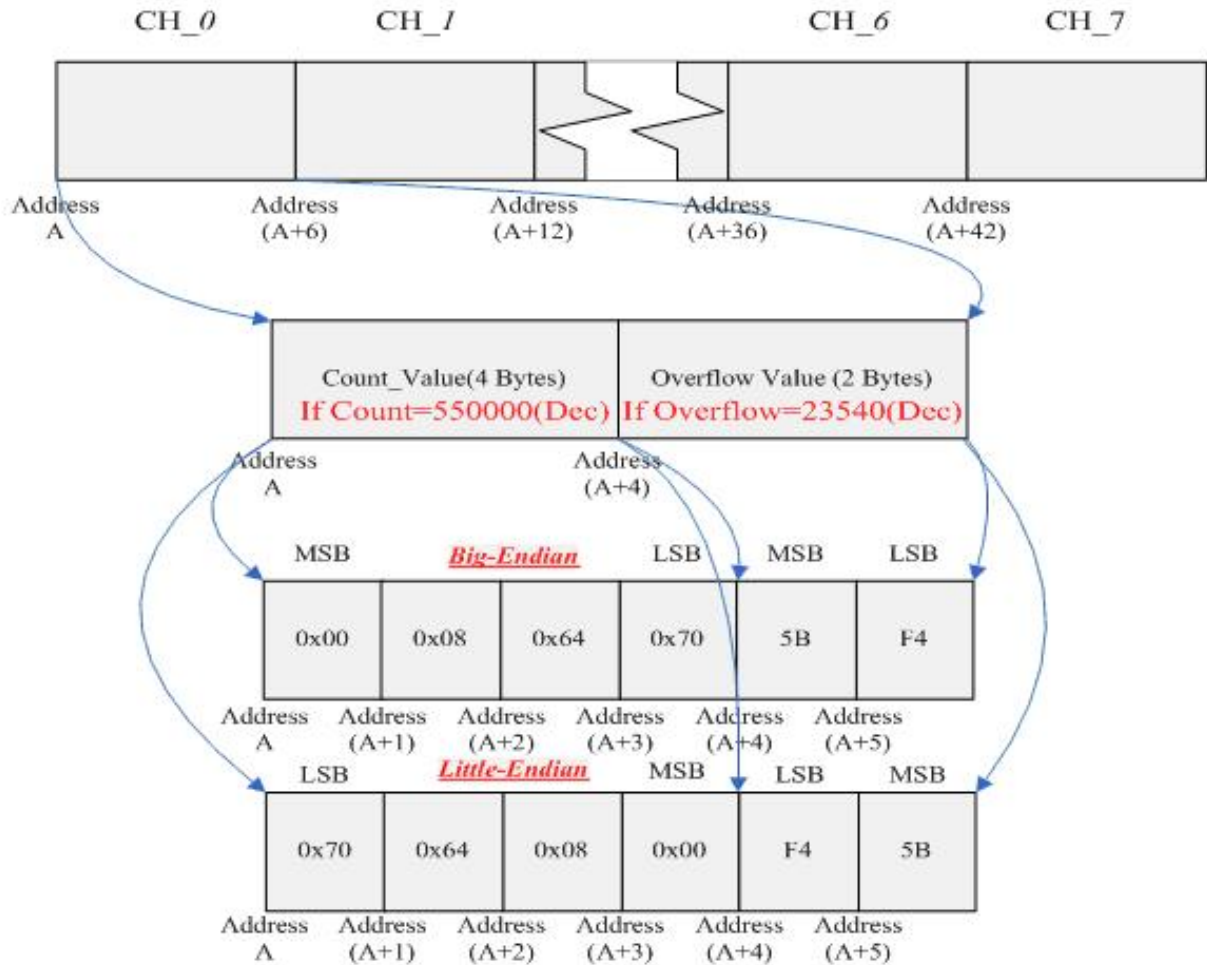

There are nine input bytes in i-87082. The last byte indicates the status of the counter, and the others are the count value of each channel. The bit arrangement of the last input byte is shown below

### i-87082 – bit arrangement of the last input byte (Overflow)

Bit.	Bit7	Bit6	Bit5	Bit4	Bit3	Bit2	Bit1	Bit0
Func.	Reserved					CH1.Overflow	CH0.Overflow	

The following figure shows the data arrangement of the input bytes in i-87082 module.

## i-87082 - Data arrangement of the input bytes (Cnt/Freq)

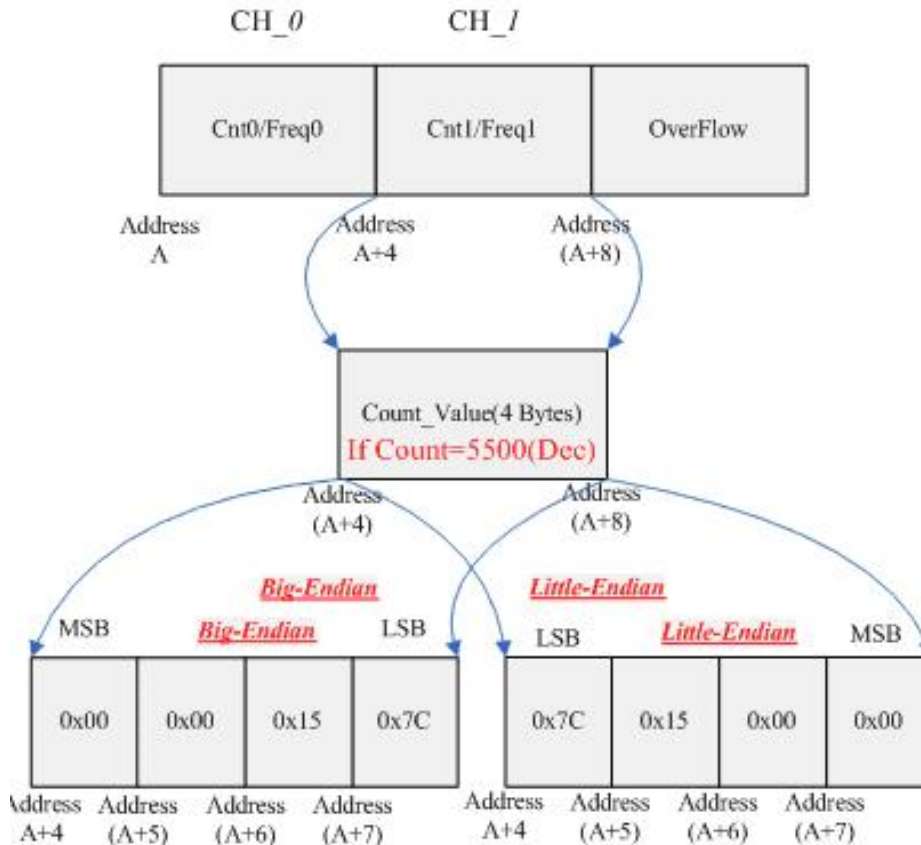

There is an additional function in both of i-8080 and i-87082. That is “Counter Clear” command. The clear command of i-8080 is the same as i-87082. It just set the corresponding bit to “1”(Level-trigger) or set it from “0” to “1” (Edge-trigger) then the count value of corresponding channel will clear soon, as show below.

### Bit Arrangement of Output Data in i-8080(1 Byte)

Bit.	7	6	5	4	3	2	1	0
Func.	Clr7	Clr6	Clr5	Clr4	Clr3	Clr2	Clr1	Clr0

Func.	Meaning	Description
ClrN	Clear Count of Channel N	Clear both overflow and count value

i-87082 provide more functionality than i-8080. They are “Start Count” and ”Stop Count”. These functionalities increase the applicability of i-87082 module. For more detail description, please refer to the following table.

### i-87082 output data (1 Byte)

Bit	7	6	5	4	3	2	1	0
Func.	E-DO.1	E-DO.0	DO.1	DO.0	C1.S1	C1.S0	C0.S1	C0.S0



Func.	Meaning	Descriptions
E-DO.1	Enable DO.1	Enable=1, DO.1 is output. Enable=0, No output.
E-DO.0	Enable DO.0	Enable=1, DO.0 is output. Enable=0, No output.
DO.1	Digital Output CH1	Digital Output value of Channel 1.
DO.0	Digital Output CH0	Digital Output value of Channel 0.
C1.S1	Channel 1 Func.Sel. 1	Channel 1 Function Selection.
C1.S0	Channel 1 Func.Sel. 0	See table below.
C0.S1	Channel 0 Func.Sel. 1	Channel 0 Function Selection.
C0.S0	Channel 0 Func.Sel. 0	See table below.

Func.S1	Func.S0	Function
0	0	No Action(Disable)
0	1	Stop counting
1	0	Start counting
1	1	Clear count

### Statistic Table of i-8K & i-87K

The following table shows the memory allocation of standard I/O and Counter / Frequency module, and we divide this table into four parts: The first table describes each function's meaning. The second table shows the input allocation of standard I/O, the third table shows the output allocation of standard I/O and the last part shows the Input/Output memory allocation of the Counter/Frequency module. We have simplified the following tables. The remainders of the table must be deduced by users.

### Function Description Table

Function Name	Meaning
$D_{a\sim b}$	Digital I/O Value(bit a~b)
$A.N_{a\sim b}$	Analog Value of Channel N(bit a~b)
$C.N_{a\sim b}$	Count Value of Channel N(bit a~b)
$CJC_{a\sim b}$	CJC Temperature(bit a~b)
$Clr_{a\sim b}$	Clear Command(bit a~b)
$OvN_{a\sim b}$	Overflow Indicator(bit a~b)

### Standard I/O – input memory allocation

Meas.Type	DI		DI w/ Count		AI		AI w/ CJC.read	
	Big	Little	Big	Little	Big	Little	Big	Little
BYTE.0	D <sub>0~7</sub>	D <sub>0~7</sub>	D <sub>0~7</sub>	D <sub>0~7</sub>	A.0 <sub>8~15</sub>	A.0 <sub>0~7</sub>	A.0 <sub>8~15</sub>	A.0 <sub>0~7</sub>
BYTE.1	D <sub>8~15</sub>	D <sub>8~15</sub>	D <sub>8~15</sub>	D <sub>8~15</sub>	A.0 <sub>0~7</sub>	A.0 <sub>8~15</sub>	A.0 <sub>0~7</sub>	A.0 <sub>8~15</sub>
BYTE.2	D <sub>16~23</sub>	D <sub>16~23</sub>	D <sub>16~23</sub>	D <sub>16~23</sub>	A.1 <sub>8~15</sub>	A.1 <sub>0~7</sub>	A.1 <sub>8~15</sub>	A.1 <sub>0~7</sub>
BYTE.3	D <sub>24~31</sub>	D <sub>24~31</sub>	D <sub>24~31</sub>	D <sub>24~31</sub>	A.1 <sub>0~7</sub>	A.1 <sub>8~15</sub>	A.1 <sub>0~7</sub>	A.1 <sub>8~15</sub>
BYTE.4			C.0 <sub>8~15</sub>	C.0 <sub>0~7</sub>	A.2 <sub>8~15</sub>	A.2 <sub>0~7</sub>	A.2 <sub>8~15</sub>	A.2 <sub>0~7</sub>
BYTE.5			C.0 <sub>0~7</sub>	C.0 <sub>8~15</sub>	A.2 <sub>0~7</sub>	A.2 <sub>8~15</sub>	A.2 <sub>0~7</sub>	A.2 <sub>8~15</sub>
BYTE.6			C.1 <sub>8~15</sub>	C.1 <sub>0~7</sub>	A.3 <sub>8~15</sub>	A.3 <sub>0~7</sub>	A.3 <sub>8~15</sub>	A.3 <sub>0~7</sub>
BYTE.7			C.1 <sub>0~7</sub>	C.1 <sub>8~15</sub>	A.3 <sub>0~7</sub>	A.3 <sub>8~15</sub>	A.3 <sub>0~7</sub>	A.3 <sub>8~15</sub>
BYTE.8			C.2 <sub>8~15</sub>	C.2 <sub>0~7</sub>	A.4 <sub>8~15</sub>	A.4 <sub>0~7</sub>	A.4 <sub>8~15</sub>	A.4 <sub>0~7</sub>
BYTE.9			C.2 <sub>0~7</sub>	C.2 <sub>8~15</sub>	A.4 <sub>0~7</sub>	A.4 <sub>8~15</sub>	A.4 <sub>0~7</sub>	A.4 <sub>8~15</sub>
BYTE.10			C.3 <sub>8~15</sub>	C.3 <sub>0~7</sub>	A.5 <sub>8~15</sub>	A.5 <sub>0~7</sub>	A.5 <sub>8~15</sub>	A.5 <sub>0~7</sub>
BYTE.11			C.3 <sub>0~7</sub>	C.3 <sub>8~15</sub>	A.5 <sub>0~7</sub>	A.5 <sub>8~15</sub>	A.5 <sub>0~7</sub>	A.5 <sub>8~15</sub>
BYTE.12			C.4 <sub>8~15</sub>	C.4 <sub>0~7</sub>	A.6 <sub>8~15</sub>	A.6 <sub>0~7</sub>	A.6 <sub>8~15</sub>	A.6 <sub>0~7</sub>
BYTE.13			C.4 <sub>0~7</sub>	C.4 <sub>8~15</sub>	A.6 <sub>0~7</sub>	A.6 <sub>8~15</sub>	A.6 <sub>0~7</sub>	A.6 <sub>8~15</sub>
BYTE.14			C.5 <sub>8~15</sub>	C.5 <sub>0~7</sub>	A.7 <sub>8~15</sub>	A.7 <sub>0~7</sub>	A.7 <sub>8~15</sub>	A.7 <sub>0~7</sub>
BYTE.15			C.5 <sub>0~7</sub>	C.5 <sub>8~15</sub>	A.7 <sub>0~7</sub>	A.7 <sub>8~15</sub>	A.7 <sub>0~7</sub>	A.7 <sub>8~15</sub>
BYTE.16			C.6 <sub>8~15</sub>	C.6 <sub>0~7</sub>			CJC <sub>8~15</sub>	CJC <sub>0~7</sub>
BYTE.17			C.6 <sub>0~7</sub>	C.6 <sub>8~15</sub>			CJC <sub>0~7</sub>	CJC <sub>8~15</sub>

### Standard I/O – output memory allocation

Meas.Type	DO		DI w/ Count		AO		AI w/ CJC.offset	
	Big	Little	Big	Little	Big	Little	Big	Little
BYTE.0	D <sub>0~7</sub>	D <sub>0~7</sub>	clr <sub>24~31</sub>	clr <sub>0~7</sub>	A.0 <sub>8~15</sub>	A.0 <sub>0~7</sub>	ChnSel	offset <sub>7~0</sub>
BYTE.1	D <sub>8~15</sub>	D <sub>8~15</sub>	clr <sub>16~23</sub>	clr <sub>8~15</sub>	A.0 <sub>0~7</sub>	A.0 <sub>8~15</sub>	Ena& offset <sub>8~15</sub>	Ena& offset <sub>8~15</sub>
BYTE.2	D <sub>16~23</sub>	D <sub>16~23</sub>	clr <sub>8~15</sub>	clr <sub>16~23</sub>	A.1 <sub>8~15</sub>	A.1 <sub>0~7</sub>	offset <sub>7~0</sub>	ChnSel
BYTE.3	D <sub>24~31</sub>	D <sub>24~31</sub>	clr <sub>0~7</sub>	clr <sub>24~31</sub>	A.1 <sub>0~7</sub>	A.1 <sub>8~15</sub>		
BYTE.4					A.2 <sub>8~15</sub>	A.2 <sub>0~7</sub>		
BYTE.5					A.2 <sub>0~7</sub>	A.2 <sub>8~15</sub>		
BYTE.6					A.3 <sub>8~15</sub>	A.3 <sub>0~7</sub>		
BYTE.7					A.3 <sub>0~7</sub>	A.3 <sub>8~15</sub>		
BYTE.8					A.4 <sub>8~15</sub>	A.4 <sub>0~7</sub>		
BYTE.9					A.4 <sub>0~7</sub>	A.4 <sub>8~15</sub>		
BYTE.10					A.5 <sub>8~15</sub>	A.5 <sub>0~7</sub>		
BYTE.11					A.5 <sub>0~7</sub>	A.5 <sub>8~15</sub>		

### Counter/Frequency memory allocation

Meas.Type	i-8080.Inp.		i-8080.Outp.		i-87082.Inp		i-87082.Outp	
	Big	Little	Big	Little	Big	Little	Big	Little
BYTE.0	C0 <sub>24~31</sub>	C0 <sub>0~7</sub>	Clr <sub>0~7</sub>	Clr <sub>0~7</sub>	C0 <sub>24~31</sub>	C0 <sub>0~7</sub>	E-DO.1 /E-DO.2 /DO.1 /DO.0 /C1.S1 /C1.S0 /C0.S1 /C0.S0	E-DO.1 /E-DO.2 /DO.1 /DO.0 /C1.S1 /C1.S0 /C0.S1 /C0.S0
BYTE.1	C0 <sub>16~23</sub>	C0 <sub>8~15</sub>			C0 <sub>16~23</sub>	C0 <sub>8~15</sub>		
BYTE.2	C0 <sub>8~15</sub>	C0 <sub>16~23</sub>			C0 <sub>8~15</sub>	C0 <sub>16~23</sub>		
BYTE.3	C0 <sub>0~7</sub>	C0 <sub>24~31</sub>			C0 <sub>0~7</sub>	C0 <sub>24~31</sub>		
BYTE.4	Ov0 <sub>8~15</sub>	Ov0 <sub>0~7</sub>			C1 <sub>24~31</sub>	C1 <sub>0~7</sub>		
BYTE.5	Ov0 <sub>0~7</sub>	Ov0 <sub>8~15</sub>			C1 <sub>16~23</sub>	C1 <sub>8~15</sub>		
BYTE.6	C1 <sub>24~31</sub>	C1 <sub>0~7</sub>			C1 <sub>8~15</sub>	C1 <sub>16~23</sub>		
BYTE.7	C1 <sub>16~23</sub>	C1 <sub>8~15</sub>			C1 <sub>0~7</sub>	C1 <sub>24~31</sub>		
BYTE.8	C1 <sub>8~15</sub>	C1 <sub>16~23</sub>			Ov0 <sub>0~1</sub>	Ov0 <sub>0~1</sub>		
BYTE.9	C1 <sub>0~7</sub>	C1 <sub>24~31</sub>						
BYTE.10	Ov1 <sub>8~15</sub>	Ov1 <sub>0~7</sub>						
BYTE.11	Ov1 <sub>0~7</sub>	Ov1 <sub>8~15</sub>						
BYTE.12	C2 <sub>24~31</sub>	C2 <sub>0~7</sub>						
BYTE.13	C2 <sub>16~23</sub>	C2 <sub>8~15</sub>						
BYTE.14	C2 <sub>8~15</sub>	C2 <sub>16~23</sub>						
BYTE.15	C2 <sub>0~7</sub>	C2 <sub>24~31</sub>						
BYTE.16	Ov2 <sub>8~15</sub>	Ov2 <sub>0~7</sub>						
BYTE.17	Ov2 <sub>0~7</sub>	Ov2 <sub>8~15</sub>						

The following figures shown below describe the state flow of data exchange. The first figure shows the state flow of data exchange. There are four modules (i-87018Z, i-87024, i-87017W and i-87082) plugged in PROFI-8455.

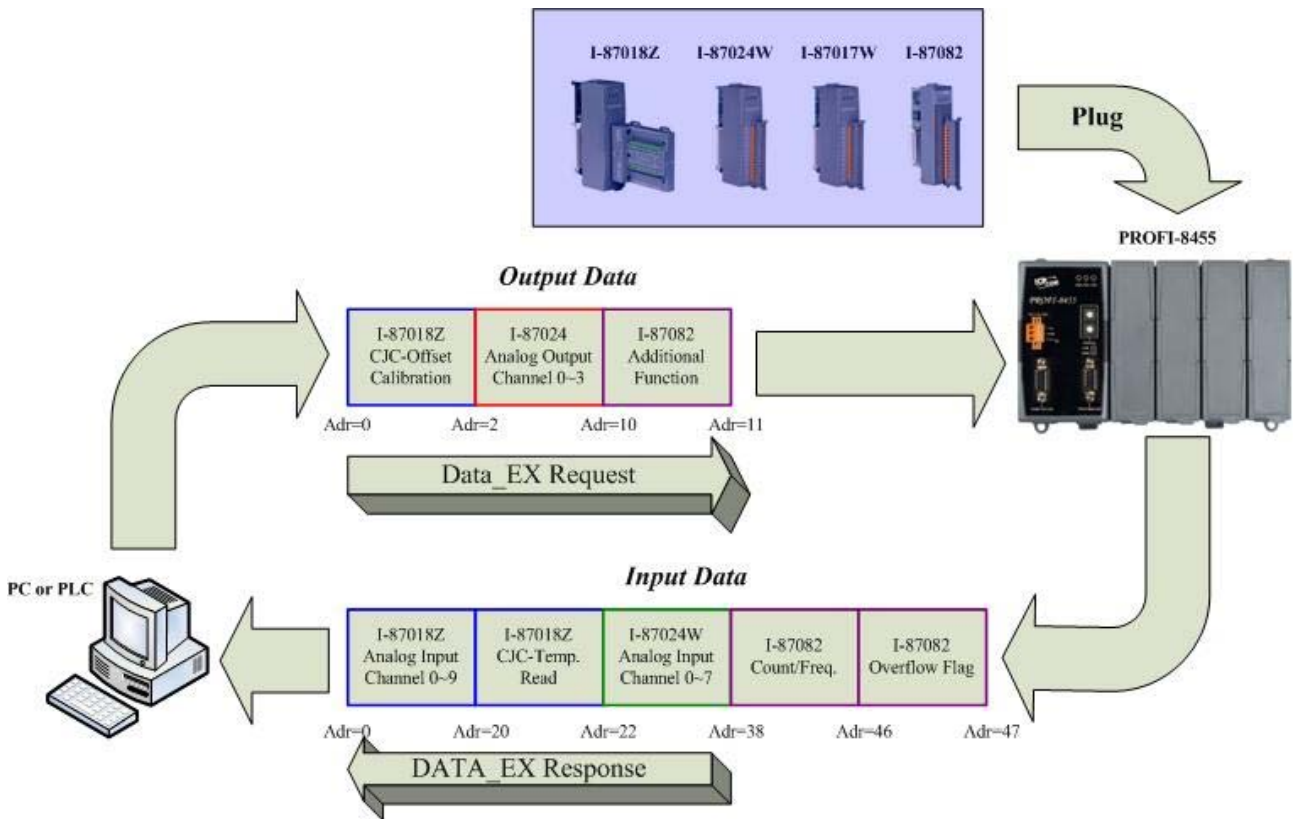

The second figure shows another state flow of data exchange. There is no output module that installation in PROFI-8455 and only input module install.

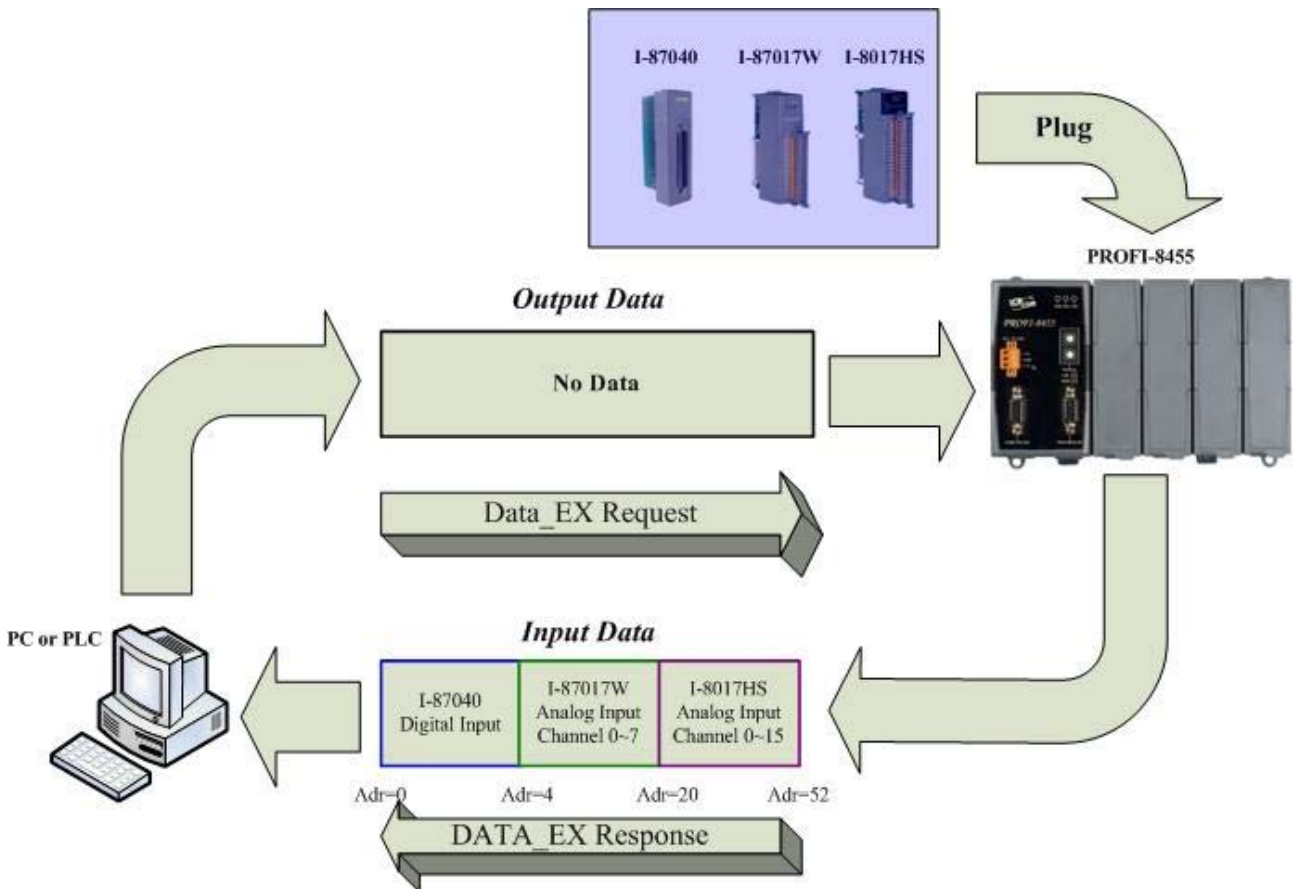

---

### 3.6. Diagnostic Message Report

The diagnostic messages report to DP-Master when the DP-Slave has errors or the unusual event is happened. Usually, It report diagnosis due to following standard channel-related event. Error code "2","3","5","6","7" and "8" are supported by PROFI-8455.

Error Code	Error Type
0	Reserved
1	Short Circuit
2	Under-voltage
3	Over-voltage
4	overload
5	Over-temperature
6	Line/wire Break(Sensor Only)
7	Upper Limit Value Exceeded(Current)
8	Lower Limit Value Exceeded(Current, Sensor)
9	Error
10~15	Reserved
16~31	Manufacture Specific/Device-Related

PROFI-8455 provides diagnosis report for Analog I/O and Counter/Frequency module. In Analog I/O module, the reason of diagnosis reports is that the input/output/count exceeds the default maximum value/minimum value or temperature sensor line break. In Counter/Frequency modules (I-87082 only), it usually due to the count exceeds the setting of "Maximum Count of Counter N" that set by Set\_Prm telegram.

You need to know that the error or unusual event occurring continuously will induce to long data exchange period. In other words, the times of data exchange in the specific time interval will decrease relatively. And diagnosis report will become the burden in the application consequently. Therefore, it is important to choose an appropriate period of diagnosis report to instead of immediate diagnosis report.

In PROFI-8455, the number of channel-related diagnostic message is limit to 39. The diagnostic messages large than 128 bytes (39 channel -related diagnoses) will be ignore. And the time interval of diagnosis report has maximum number of 65535 and minimum number of 0.

The channel-related diagnosis has been described above. There is another kind of diagnosis provided by PROFI-8455; it is called device-related diagnosis. The device-related diagnosis in PROFI-8455 is “Offline-Detection”. When the module is unplugged or breakdown, PROFI-8455 will report the error with device-related diagnosis. The error-id and corresponding meaning is shown in following table.

Error ID	Meaning
1	Slot 0- Module Offline
2	Slot 1- Module Offline
4	Slot 2- Module Offline
8	Slot 3- Module Offline

Several offline modules can be detected at the same time. PROFI-8455 combines these Error-IDs into one byte and return to DP-Master once. For example, we can know that all the modules in PROFI-8455 are disconnect (offline) when DP-Master gets a device-related diagnosis with error code “15”. There are two examples that describe different error or warning event as follows. The first example is about that the I-87082 module unplugged out of PROFI-8455 and the diagnostic message reports. The following figure can shows the report process.

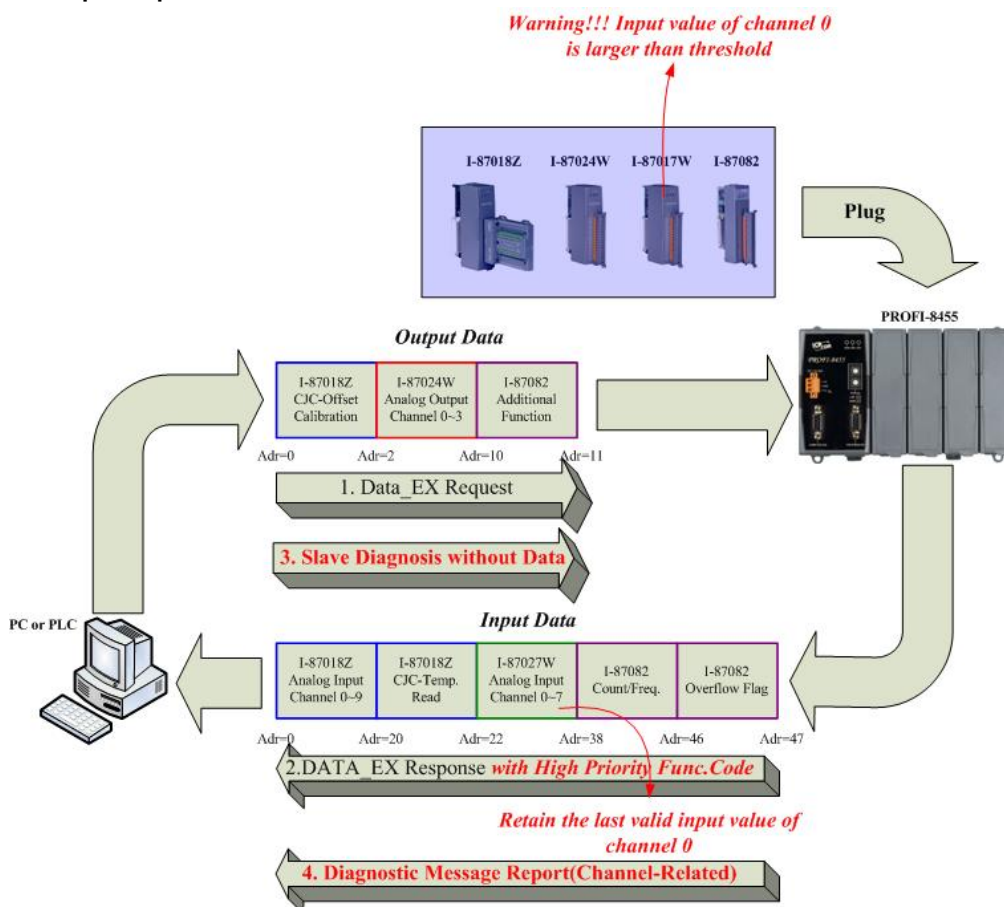

The second example is about the input value of channel 0 of I-8017W is larger than threshold value, and the diagnostic message reports. The following figure can shows the report process.

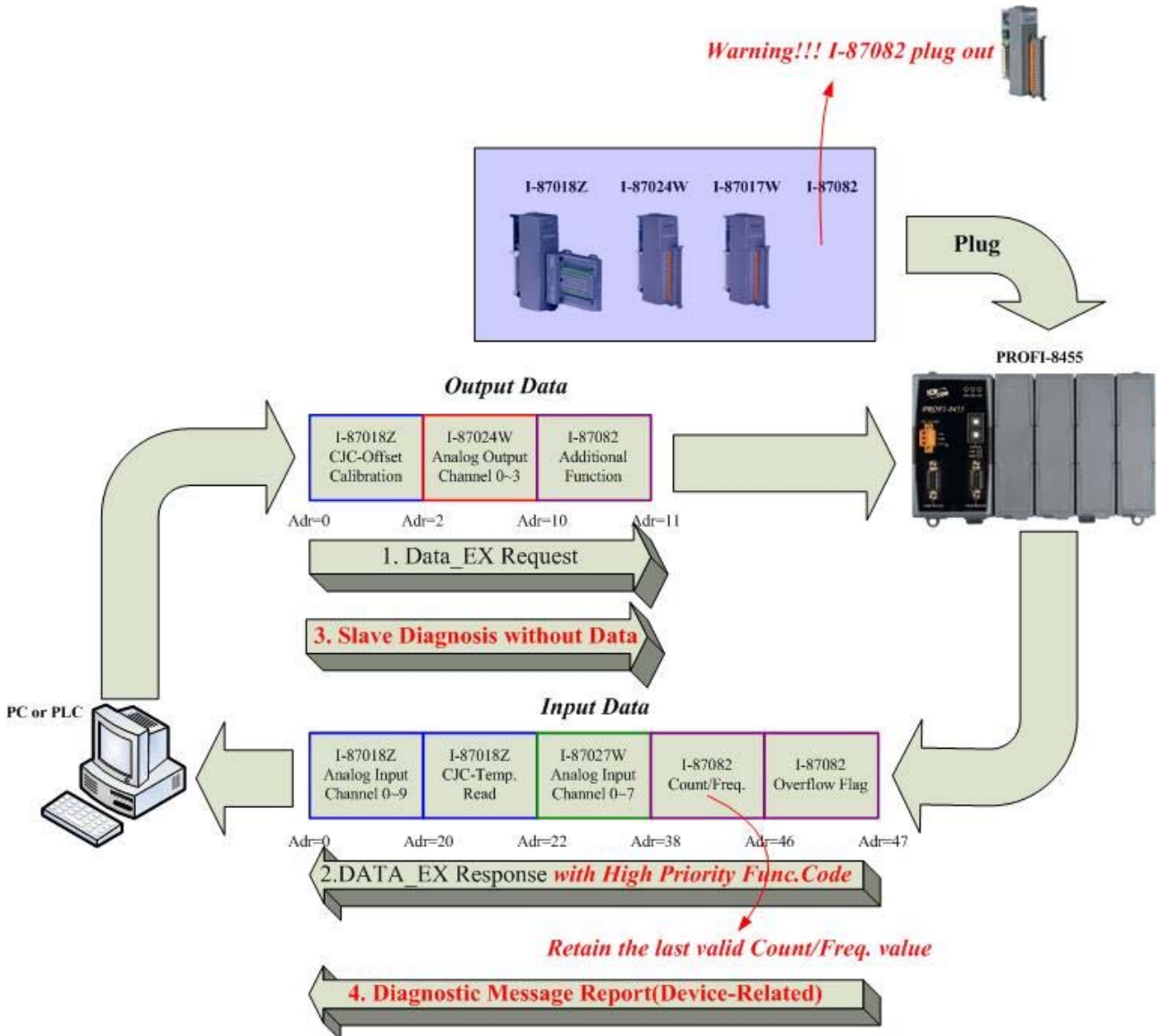

### 3.7. Establish connection with PROFI-8455

Before establish the connection between DP-Master and PROFI-8455, user should obey the following step first.

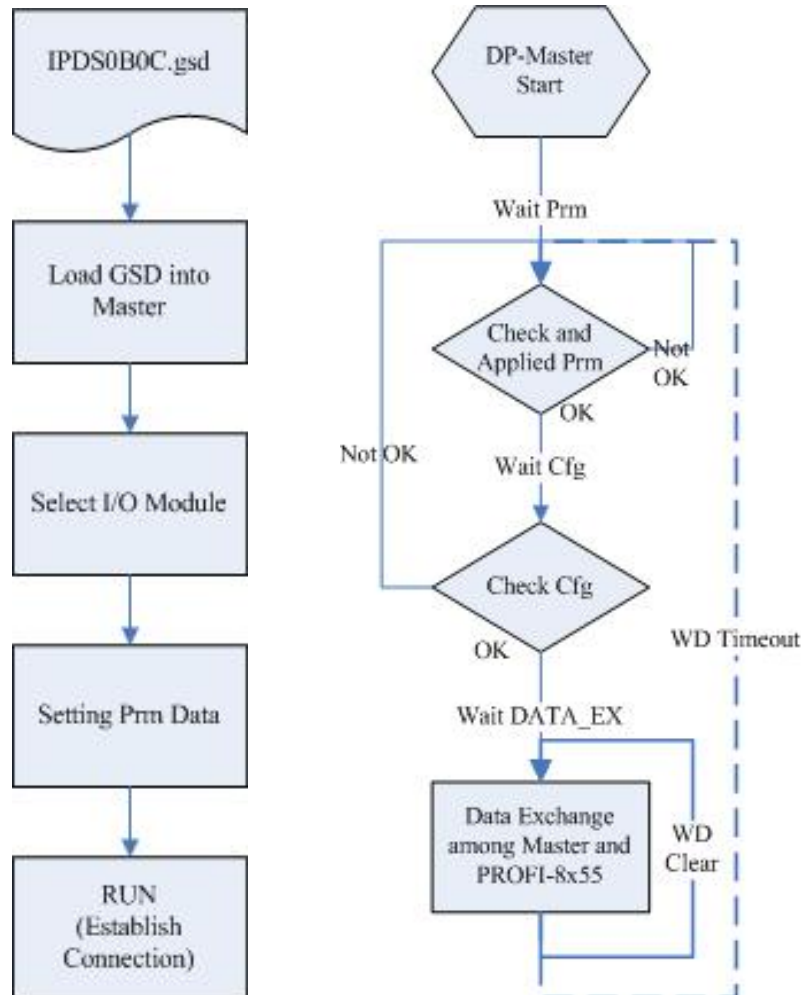

First, users must load the electronic device description file(GSD file) of the PROFI-8455 into the DP-Master, then set the parameters of the modules plugged in PROFI-8455 respectively. Finally change your DP-master from Offline state to Operate state. While DP-Master changes to operate mode, PROFI-8455 will initial the modules. Then PROFI-8455 allocates the memory space and waits for Set\_Prm telegram. The next step is waiting for Chk\_Cfg telegram in order. If there is no error occurs, PROFI-8455 proceeds into data exchange state. Users can observe the status indicator LED to know the state of PROFI-8455. At the meantime, if there is any error occurs, PROFI-8455 will return to wait parameterization.



---

### 3.8. Telegram cycle of data exchange

If you want to know the round-trip time of a data exchange telegram, you must know how a byte enveloped into a serial stream. In series communication, the byte transmission includes start bit, stop bit, data field and optional parity. According to the PROFIBUS specification, there is no parity bit in transmission. Therefore, one data byte will be encoded to 11 bits. Consequently, the telegram cycle time of data exchange will calculate as follow.

$$T = (\text{Output data Bit Time (header include)} + \text{Station Reaction Bit Time} + \text{Input Data Bit Time (header include)} + \text{Bus Idle Bit Time} + \text{Sync-Bit Time}) * \text{Transmission Time per Bit.}$$

$$\text{Output Data Bit Time (header include)} = (9 + \text{length of output data in Byte}) * 11$$

Station Reaction Time = Any Value that large than Min.Tsdr and smaller than Max.Tsdr

There is look up table between Baud Rate and Max.Tsdr. (This information is in GSD file)

Baud Rate(in bit per second)	Max.Tsdr (in Tbit)
9600	60
19,200	60
454,500	60
937,500	60
187,500	60
500,000	100
1,500,000	150
3,000,000	250
6,000,000	450
12,000,000	800

$$\text{Input Data Bit Time (header include)} = (9 + \text{length of input data in Byte}) * 11$$

$$\text{Bus Idle Time} = \max (T_{\text{SYN}} + T_{\text{SM}} , \min T_{\text{SDR}} , T_{\text{SDI}})$$

---

For the detail, please refer to PROFIBUS Specification.

Sync. Bit Time = 33 (constant)

Transmission Time per Bit = the inverse of Baud Rate.

For example:

The data transmission time with 15 bytes output data and 30 bytes input data in 12Mbps is calculated as follows.

Parameter :  $T_{\text{SYN}}=33$  Tbits

$T_{\text{ID1}}=75$  Tbits (1.5M BR)

$T_{\text{SDR}}=30$  Tbits (1.5M BR)

Min\_Slave\_Interval = 1

The time is as follows.

$$T = ( (9+15) * 11 + 30 + (9+30) * 11 + 33 + 75 ) / 12 * 10^6 = 69.25\mu\text{S}$$

---

## 4. PROFI-8455 Guideline (Based on SyCon)

In this chapter, we make a demo with PROFI-8455 and the DP-Master of SyCon company. The demo is shown how to apply the PROFI-8455 in a realistic system.

### 4.1. Preprocessing

1. New a project:

Click <File->New> to establish a PROFIBUS project.

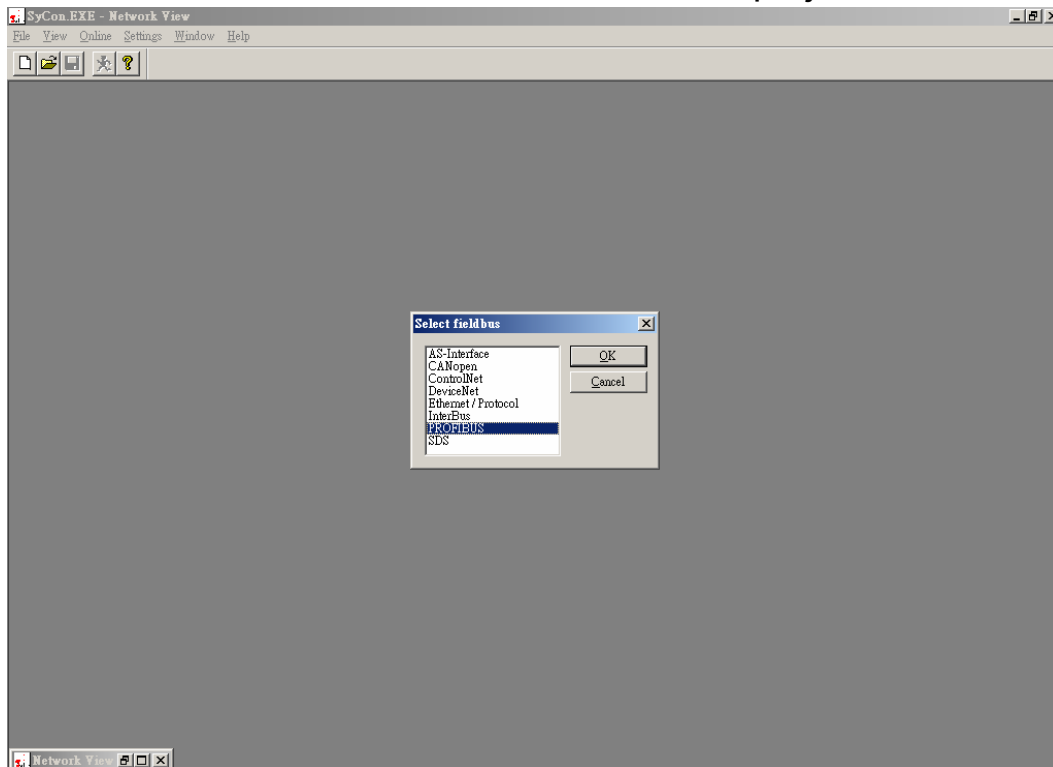

2. Import GSD file:

Click <File->CopyGSD> to copy IPDS0B0C.gsd file into your SyCon.

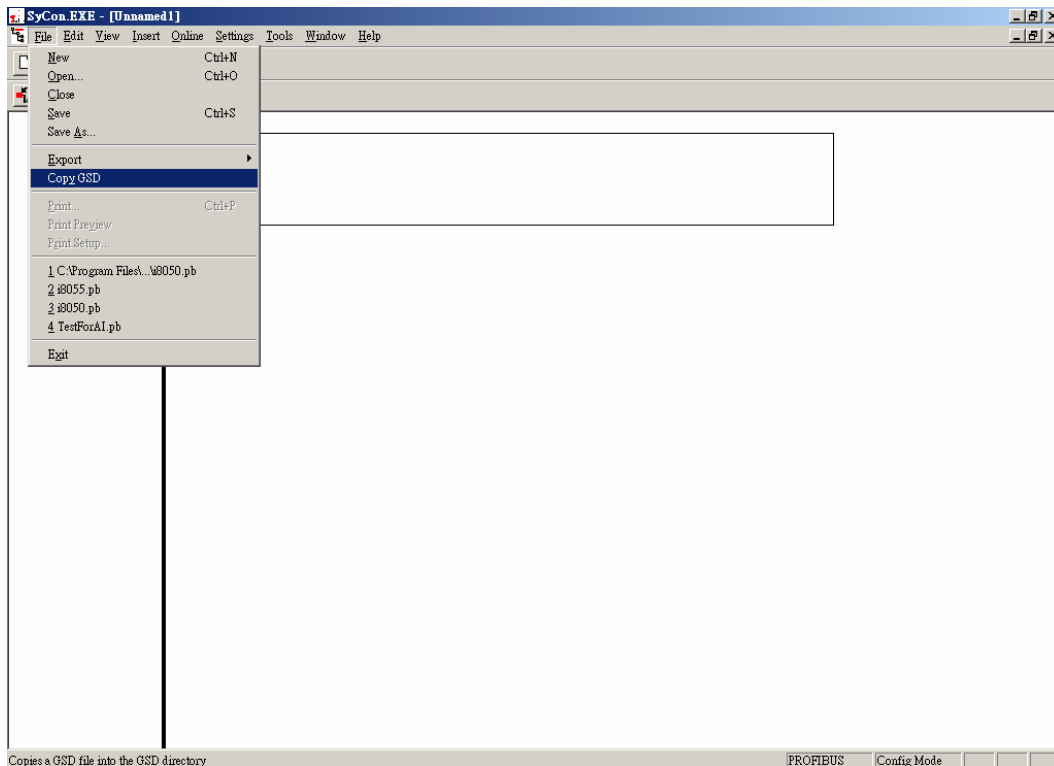

3. Add DP-Master to PROFIBUS network:  
 Adding corresponding PROFIBUS DP Master into PROFIBUS network,  
 and modify the station address yourself.

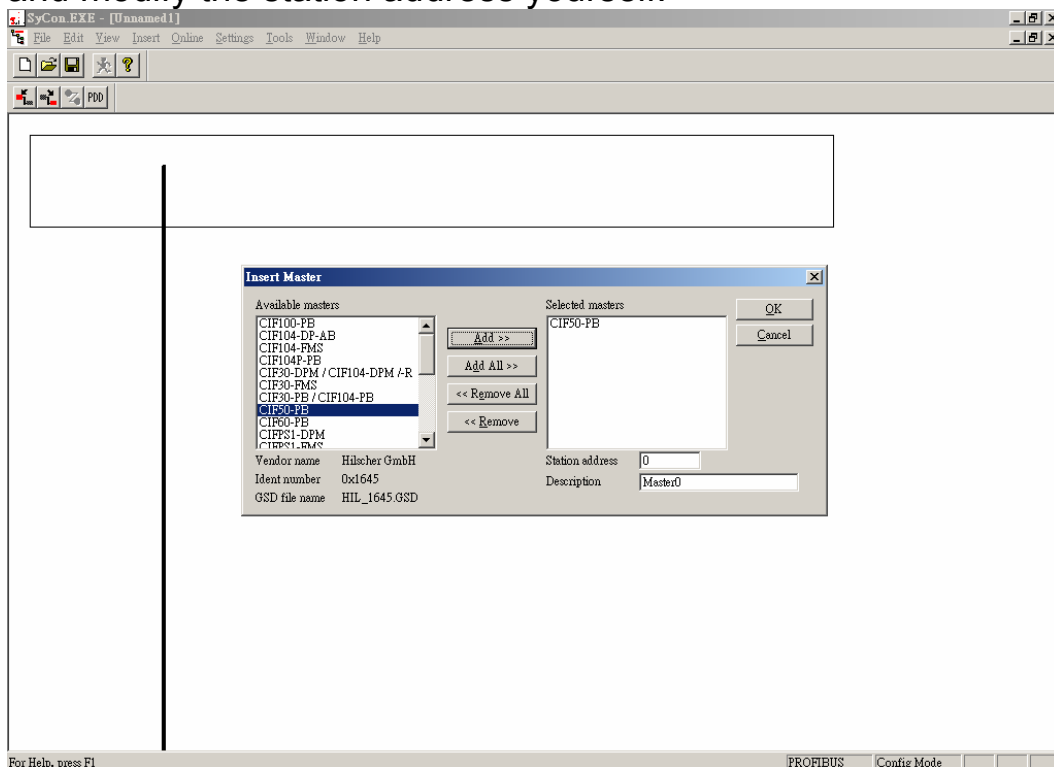

4. Add DP-Slave to PROFIBUS network:  
 After copying the GSD file into SyCon, you can add “PROFI-8455” to  
 PROFIBUS network, and modify the station address yourself.

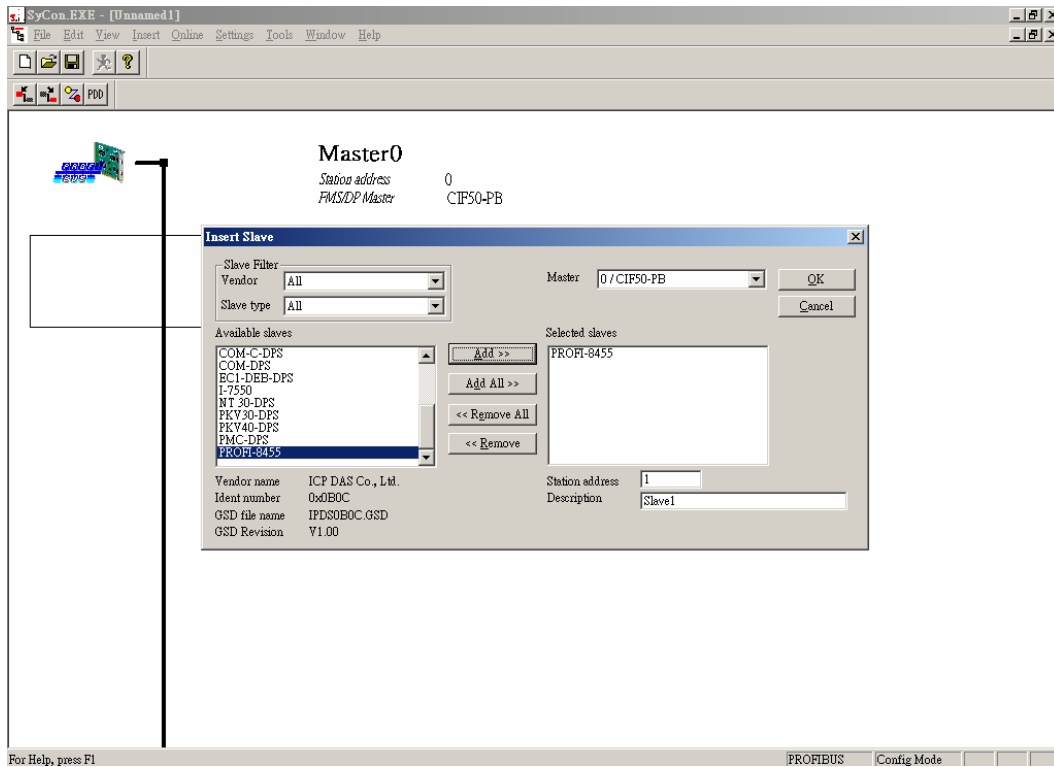

## 5. Modify the configuration of PROFI-8455:

### 1. Add module(s):

Add the module(s) you want to use. In this example, we choose i-8017H and i-8024.

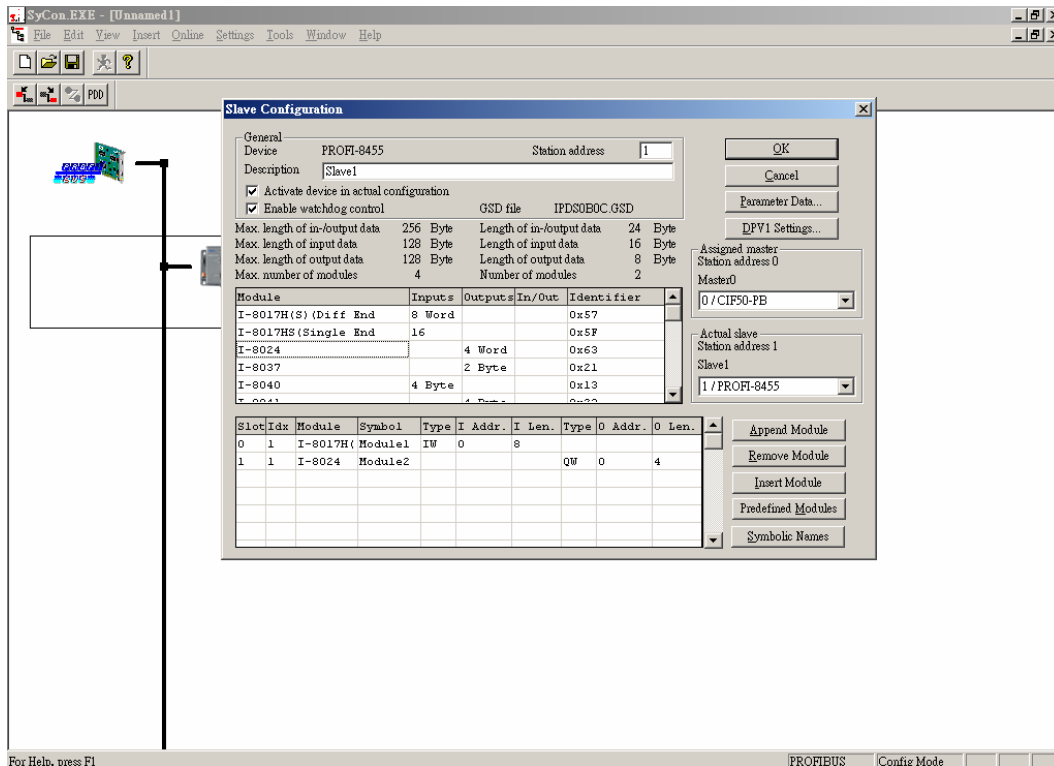

### 2. Modify parameter data :

Click <Parameter Data> button in right-up corner of the windows, and modify the “Common” and “Module” parameter by your preference. In this example, we use default setting.

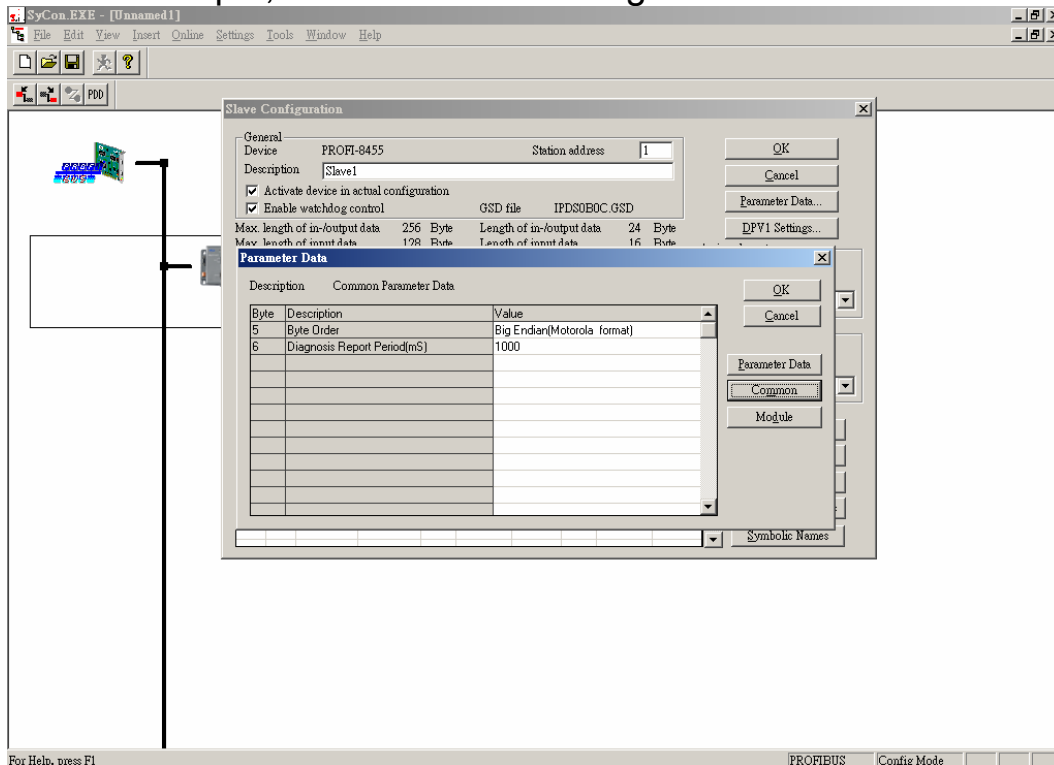

6. Download the network configuration to DP-Master :  
Click <Online->Download> to download the network setting into CIF 50-PB card.

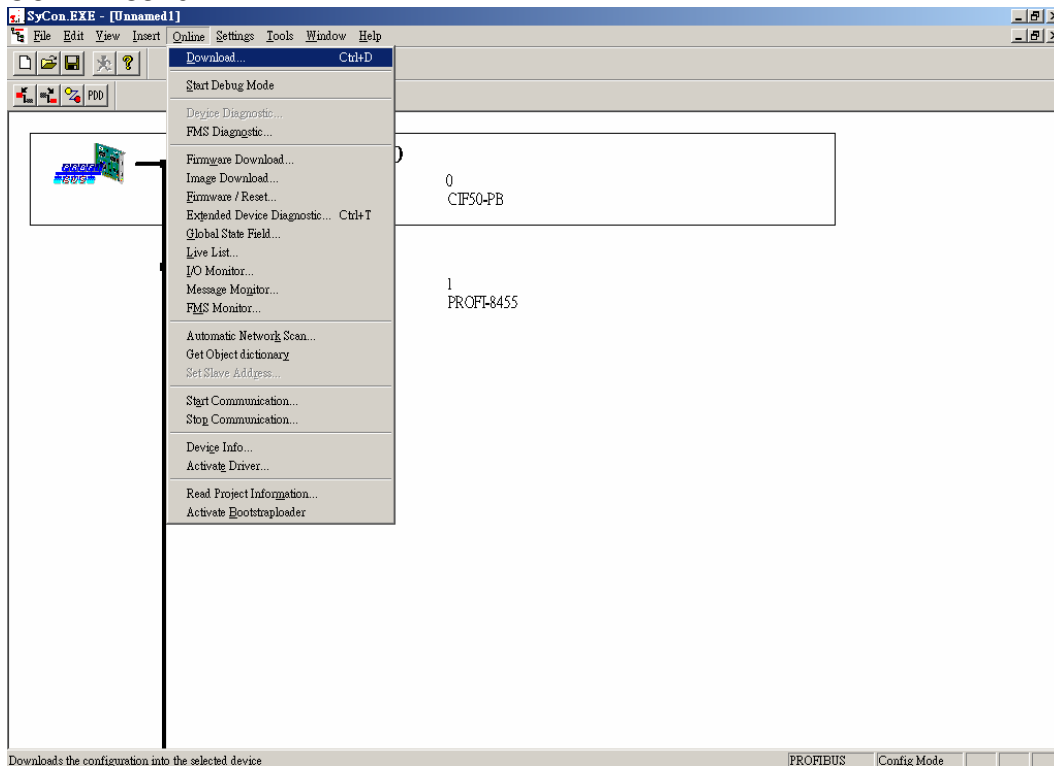

7. Install Module(s):

In this example, we plug i-8017H and i-8024 into expansion slot in PROFI-8455 in order.



---

8. Adjust the rotary switches:

In previous step, we modify the address of DP-Slave to "1", so we must adjust the rotary switches to 01 in PROFI-8455 panel.



9. Power supplied :

Plug the power terminator with 24VDC to PROFI-8455.





## 4.2. I/O View/Modify

### 1. Click View->Logical Network View

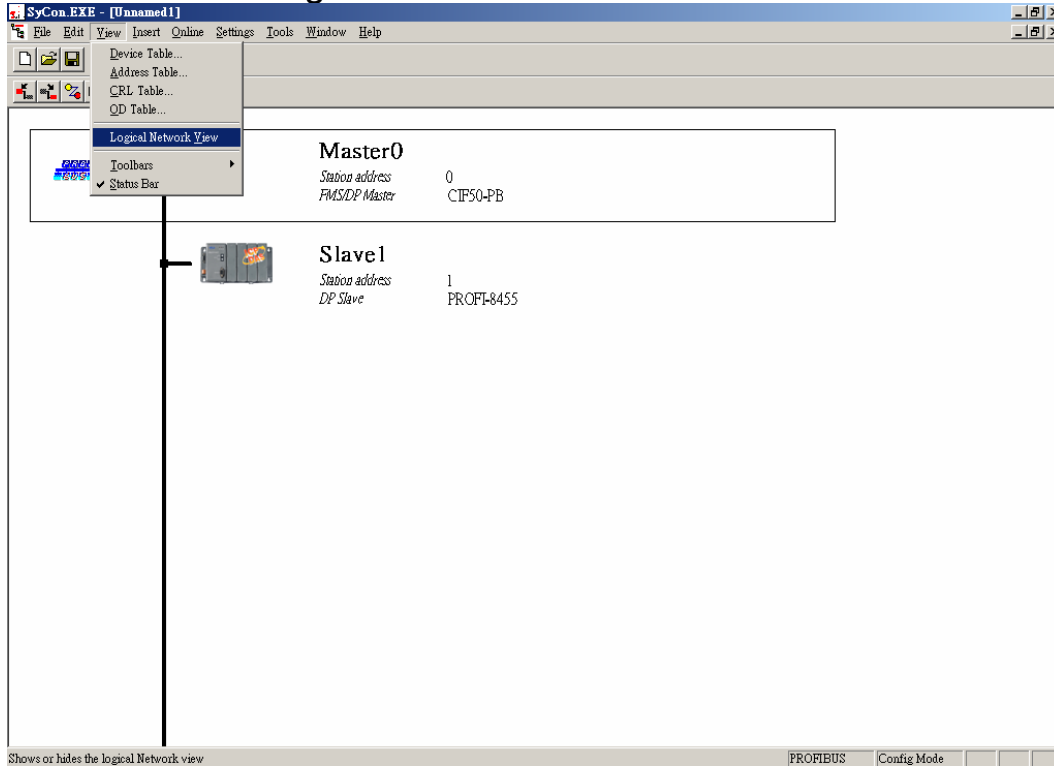

### 2. Monitoring I/O data of Module(1):

Add the input signal of Module 1 (i-8017H) into I/O Watch.

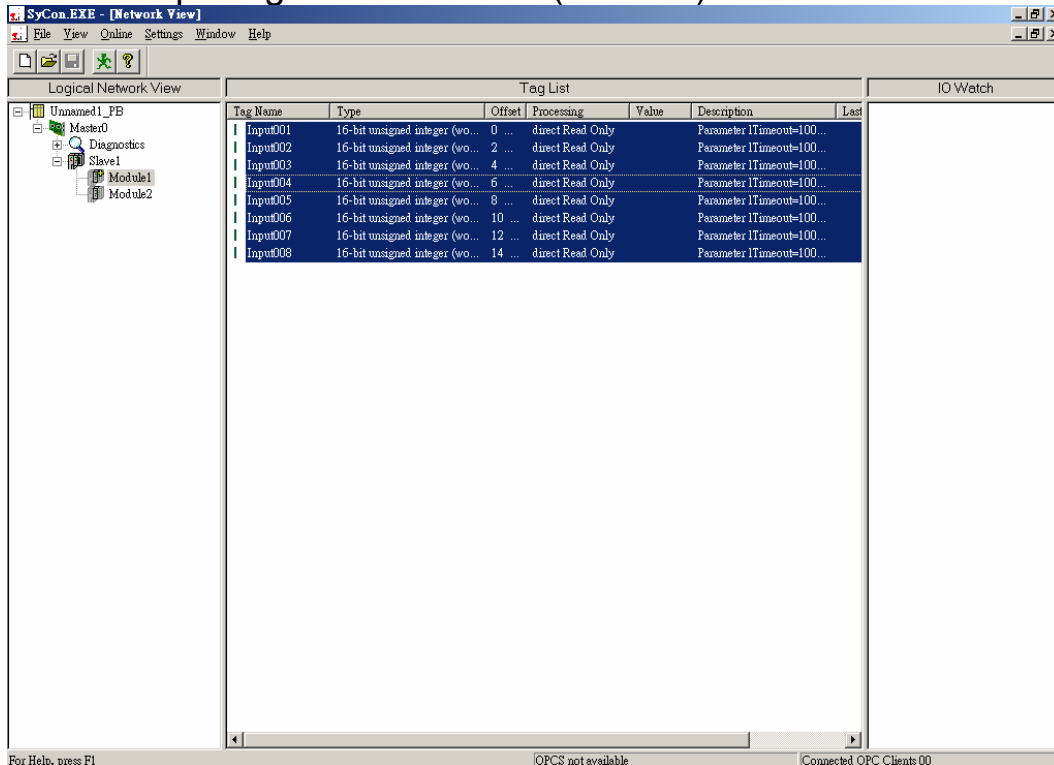

### 3. Monitoring I/O data of Module(2): Add the output signal of Module 2 (i-8024) into I/O Watch.

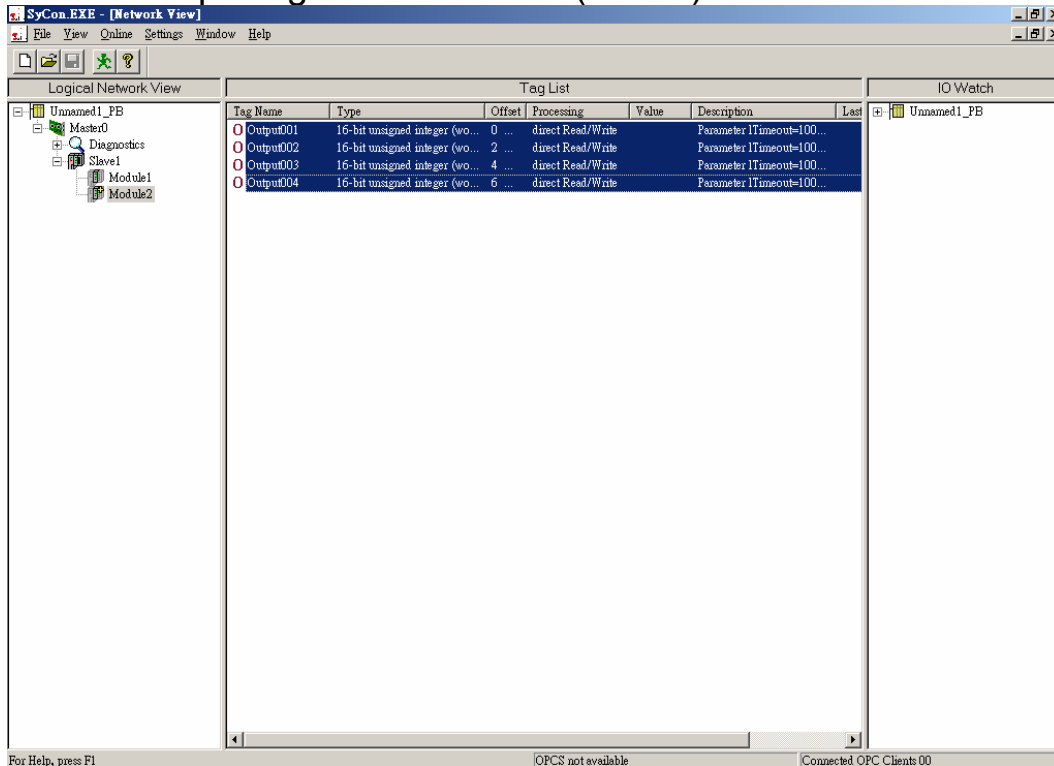

### 4. Start Monitoring:

Click the right button of mouse at <Slave1>, choose Start to enable monitor.

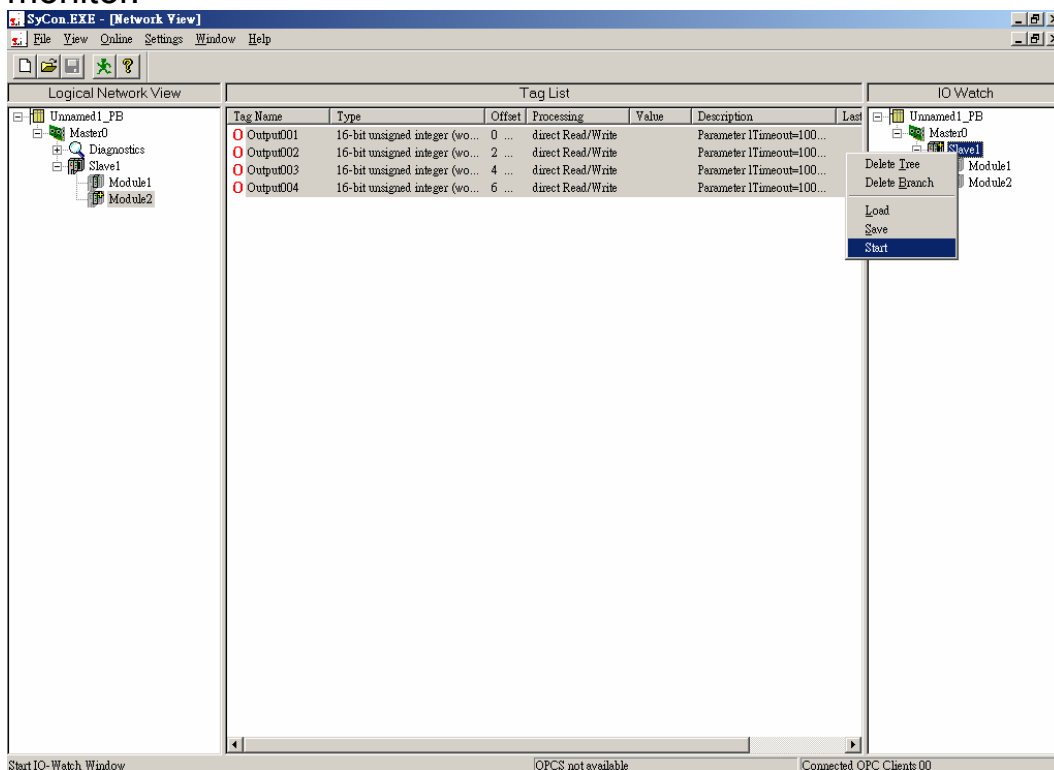

I/O Watch window shows a list of present state of I/O, SymName with Input00x is read-only, and SymName with Output00x is write-only.

SyCon.EXE - [Network View]

File View Online Settings Window Help

IO Watch [Settings not saved yet]

Device	SymName	IEC-Address	Data-Type	Representation	Value
Slave1.Module1	I Input001	0	Word	Hex	00 00
Slave1.Module1	I Input002	2	Word	Hex	00 00
Slave1.Module1	I Input003	4	Word	Hex	00 00
Slave1.Module1	I Input004	6	Word	Hex	00 00
Slave1.Module1	I Input005	8	Word	Hex	00 00
Slave1.Module1	I Input006	10	Word	Hex	00 00
Slave1.Module1	I Input007	12	Word	Hex	00 00
Slave1.Module1	I Input008	14	Word	Hex	01 00
Slave1.Module2	O Output001	0	Word	Hex	00 00
Slave1.Module2	O Output002	2	Word	Hex	00 00
Slave1.Module2	O Output003	4	Word	Hex	00 00
Slave1.Module2	O Output004	6	Word	Hex	00 00

C:\Program Files\Hilscher\SyConProject\Unnamed1.PB

IO Watch

Node	Description	Last
Parameter ITimeout=100...		
Parameter ITimeout=100...		
Parameter ITimeout=100...		
Parameter ITimeout=100...		
Parameter ITimeout=100...		
Parameter ITimeout=100...		
Parameter ITimeout=100...		
Parameter ITimeout=100...		
Parameter ITimeout=100...		
Parameter ITimeout=100...		

IO Watch Tree:

- Unnamed1\_PB
  - Master0
    - Slave1
      - Module1
      - Module2

For Help, press F1

OPCS not available

Connected OPC Clients 00

---

## 5. GSD File

A GSD is a readable ASCII text file and contains both general and device-specific specifications for communication. Each of the entries describes a feature that is supported by a device. A GSD replaces the previously conventional manuals and supports automatic checks for input errors and data consistency, even during the configuration phase.

PROFI-8455 GSD file is located at ICPDAS Product CD and the following web site

<http://www.icpdas.com/products/Industrial/profibus/profi-8455.htm>