

# USB-87P1/2/4/8

## User Manual

Version 1.0

March , 2008

Original Writer: Martin Hsu

Last Writer: Janice Hong



---

ICP DAS, Co., LTD [www.icpdas.com](http://www.icpdas.com)

# Table of Contents

<b>Chapter 1</b>	<b>Introduction</b> .....	<b>4</b>
1.1	Specifications .....	7
<b>Chapter 2</b>	<b>Hardware Configuration</b> .....	<b>8</b>
2.1	Install USB Driver .....	8
2.2	View of the USB-87PN .....	10
2.2.1	Preparation .....	10
2.2.2	Wire the 87Pn to power and PC .....	11
2.2.3	USB-87Pn's CPU module: .....	11
2.2.4	USB-87Pn series CPU Module Description.....	12
2.2.5	Plug in the I/O modules: .....	12
2.2.6	Wiring the I/O modules: .....	13
2.2.7	Installing USB-87Pn extension unit .....	15
<b>Chapter 3</b>	<b>Software Configuration</b> .....	<b>16</b>
3.1	Setup USB-87Pn with DCON Utility .....	16
3.1.1	87Pn Auto Config. Enable:.....	18
3.1.2	87Pn Auto Config. Disable:.....	20
3.2	Save & Load 87Pn Configure file .....	20
3.2.1	Save the Configure file: .....	21
3.2.2	Load the Configure file.....	22
3.3	Load & Write the configure file .....	24
3.4	Operating in off-line mode: .....	25
<b>Chapter 4</b>	<b>Software Development Kits (SDK)</b> .....	<b>30</b>
4.1	DCON DLL .....	30
4.1.1	DLL Use Steps .....	30
4.1.2	VB Example (Reading an analog input value) .....	32
4.2	DCON ActiveX.....	34
4.2.1	Procedure for using the ActiveX .....	34
4.2.2	VB Example (Reading an analog input value) .....	35
4.3	DCON LabVIEW.....	37
4.3.1	Procedure for using DCON_LabVIEW.....	37
4.3.2	LabVIEW Example (Reading multi-channel analog Input value) .....	39
4.3.3	LabVIEW Demo Program (Reading multi-channel analog input value).....	40
4.4	DCON Indusoft .....	41
4.4.1	Procedure for using the Indusoft bundled driver.....	41
4.4.2	Indusoft Example (Reading an analog input value) .....	42
4.5	NAP OPC Server.....	45
4.5.1	Procedure for using the OPC server.....	45
4.5.2	OPC Server Example (Reading an analog input value) .....	46
<b>Appendix A : Dimension</b>	.....	<b>47</b>
<b>Appendix B : Compare USB-87Pn with i-87Kn</b>	.....	<b>52</b>
<b>Appendix C : Solution for 87K I/O module on the slot</b>	.....	<b>53</b>
<b>Appendix D : Description For ini Files</b>	.....	<b>57</b>
<b>Appendix E : Frame Ground</b>	.....	<b>58</b>

# FIGURE

Fig.2 : View of 87Pn .....	10
Fig.3 : Wire the 87Pn to power and PC .....	11
Fig.4 : 87Pn's CPU Module .....	11
Fig.5 : USB-87P1/2/4/8 CPU module description .....	12
Fig. 6 : Plug in the I/O module .....	12
Fig. 7 : Description of LED indicator .....	13
Fig. 8 : i-87019R - Internal I/O structure .....	13
Fig. 9 : i-87019R - Pin assignments & Wire Connection.....	14
Fig.10 : I/O module terminal connection.....	14
Fig.11 : Installing USB-87Pn extension unit .....	15
Fig. 12 : Run Dcon Utility and search 87Pn.....	16
Fig.13 : Auto Config. Enable, setup the 87Pn .....	18
Fig.14 : Follow 3 steps, write the settings to 87Pn.....	18
Fig.15 : Complete the 87Pn configuration then serch again.....	19
Fig.16 : After configuring, you can find out the entire module .....	19
Fig. 17 : When 87Pn Auto Config.: Disable, all the module can external communication .....	20
Fig. 18 : Save the configuration file .....	21
Fig. 19 : Load the configuration file .....	22
Fig. 20 : Load & Write the configuration file.....	24
Fig. 21 : Configure and save file in off-line mode .....	25
Fig. 22 : Load & write Configuration file through other PC .....	26
Fig. 23 : Off-line operation.....	26
Fig. 24 : Off-line operation – Configure & Save file .....	27
Fig. 25 : Load configure file in another PC .....	28
Fig. 26 : Write the settings to USB-87Pn.....	29
Fig. 27 : i-87K high/low profile series I/O modules .....	52
Fig. 28 : The search result between 87Pn and modules .....	53
Fig. 29 : DCON Utility shows the status of 87Pn expansion slot .....	53
Fig. 30 : Frame Ground .....	58
Fig. 31 : Connect to the Earth Ground.....	58

# Chapter 1 Introduction

USB-87Pn series is a intelligent I/O expansion unit, it features USB communication interface, hot swap, and most of all, this I/O unit can expand its functions by putting in any kind of i-87K series (High profile) modules. It used for industrial monitoring and controlling applications. There are more than 30 I/O modules supported with the unit, including analog input/output, digital input/output, and counter/frequency I/O modules.

USB-87Pn is designed to be used in harsh and noisy environment, so the hardware is manufactured with wide power input range (10~30VDC) and operating temperature (-25°C ~ +75°C). It simplifies installation and maintenance of I/O modules with hot swap and auto configuration, fault and error detection, dual watchdog, programmable power on and safe values.

Various software development kits (SDK) and demos are provided, such as DLL, ActiveX, Labview driver, Indusoft driver, Linux driver, OPC server, etc. The i-87K series I/O modules plugged in the USB-87Pn can be easily integrated into variant software system.

## Features

### ▶ Hot Swap

The USB-87Pn doesn't need to shut down its power to replace or plug i-87K I/O modules. Therefore, the whole system can keep operating without any interruption.

### ▶ Auto-Configuration

Configurations of i-87K I/O modules can be pre configured and stored in the nonvolatile memory of the USB-87Pn. When the USB-87Pn is power on or an i-87K I/O module is plug in, the USB-87Pn automatically check and restore these configurations to each i-87K I/O modules on it.

### ▶ Easy Duplicate System

Using the DCON Utility, you can easily make a backup of the i-87K module configurations and write to another USB-87Pn. This design can easily and quickly duplicate many USB-87Pn.

### ▶ Easy Maintenance and Diagnostic

The basic configurations (Auto Config, ON/OFF) are set by the DIP switch. The operator can use only one screwdriver to set the USB-87Pn. And there are several LED status indicators to show whether i-87K modules are configured and work properly.

If one i-87K module is damage, the user just need to get the same model number and

good i-87K module to replace the damaged one. And then check the LED indicators to know whether the replacement is performed correctly. The switch and LED design makes it easy for maintenance. There is no PC and Notebook needed.

## ► Communication

### ■ RS-485 industrial multi-drop network

The USB-87Pn uses the industrial EIA RS-485 communication to transmit and receive data over long distance (1.2 Km).

### ■ DCON protocol

i-87K series I/O modules plugged in a USB-87Pn provide a simple command/response protocol (Called DCON protocol) for communication. All command/response are in easy used ASCII format.

## ► Rugged Industrial Environment

### ■ Dual watchdog design

The i-87K series I/O modules provides module watchdog and host watchdog. The module watchdog is a hardware watchdog; the host watchdog is a software watchdog. The module watchdog is designed to automatically reset the microprocessor when the module hangs. The host watchdog monitors the host controller (PC or PLC). The output of module can go to the safe value state when the host fails.

### ■ Programmable power on and safe value

The analog and digital output of modules can be programmed power on and safe value.

### ■ Wide range power input (10~30 VDC)

Wide range operating temperature (-25 °C ~ +75 °C)

## ► Fully Software Support

The free charge software utility and development kits include

### ■ DCON Utility: for configuration

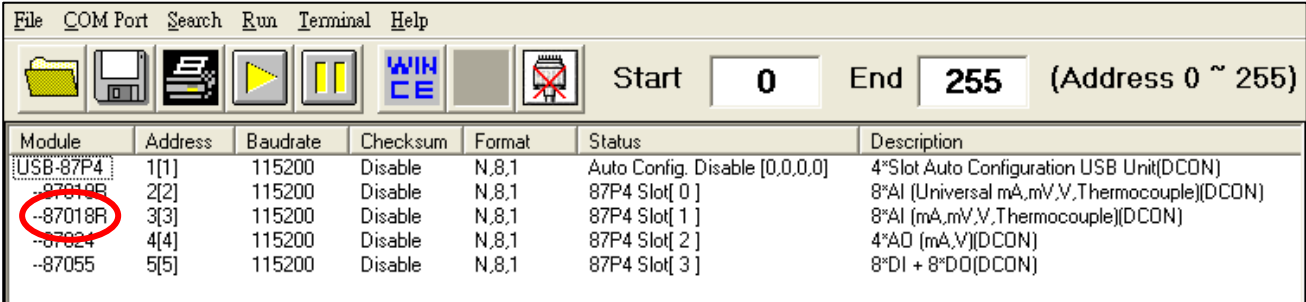

The screenshot shows the DCON Utility software interface. At the top, there is a menu bar with 'File', 'COM Port', 'Search', 'Run', 'Terminal', and 'Help'. Below the menu bar is a toolbar with icons for file operations, a 'WIN CE' logo, and a 'Start' button. To the right of the 'Start' button are input fields for '0' and '255', with the text '(Address 0 ~ 255)'. Below the toolbar is a table with the following columns: Module, Address, Baudrate, Checksum, Format, Status, and Description.

Module	Address	Baudrate	Checksum	Format	Status	Description
USB-87P4	1[1]	115200	Disable	N,8,1	Auto Config. Disable [0,0,0,0]	4*Slot Auto Configuration USB Unit(DCON)
-87018R	2[2]	115200	Disable	N,8,1	87P4 Slot[ 0 ]	8*AI (Universal mA,mV,V,Thermocouple)(DCON)
-87018R	3[3]	115200	Disable	N,8,1	87P4 Slot[ 1 ]	8*AI (mA,mV,V,Thermocouple)(DCON)
-87024	4[4]	115200	Disable	N,8,1	87P4 Slot[ 2 ]	4*AO (mA,V)(DCON)
-87055	5[5]	115200	Disable	N,8,1	87P4 Slot[ 3 ]	8*DI + 8*DO(DCON)

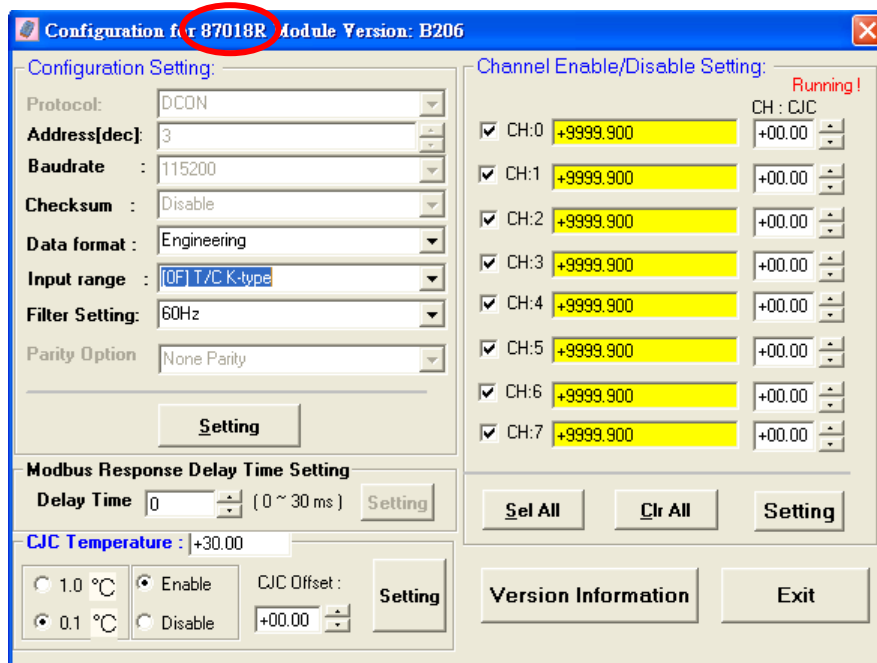

### ■ OPC Servers:

OPC is an industrial standard interface based on OLE technology. With the OPC server, I/O modules can be easily integrated to any software that has OPC client capability.

### ■ EZ Data Logger

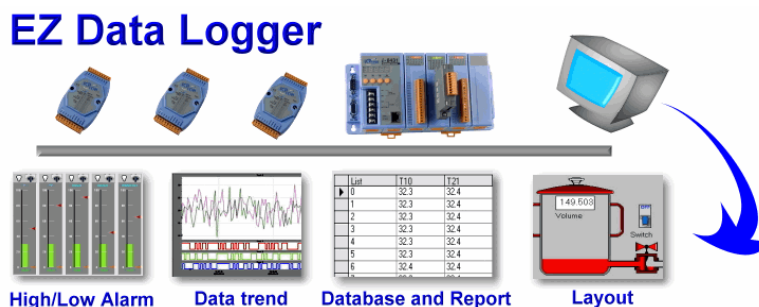

EZ Data Logger is small data logger software. It can be applied to small remote I/O system. With its user-friendly interface, users can quickly and easily build a data logger software without any programming skill.

### ■ Support Variant Software Develop Toolkits

The free charge for DLL, ActiveX, Labview driver, Indusoft driver, DasyLab driver, Linux driver.

# 1.1 Specifications

■ Communication Interface (USB)		
Baud rate	115200 bps maximum	
Isolation	3000 VDC	
■ Switch		
DIP Switch	Auto config. enable / disable	
■ LED Indicators		
Power	Yes	
System Ready	Yes	
Auto-Configuration	Yes	
Slot Status	Yes	
■ I/O Expansion Slots		
Hot Swap	Yes	
Auto-Configuration	Yes	
Support Module Type : High profile i-87K module only		
<i>Dimensions (W x H x D)</i>		
USB-87P1 (slot x 1)	63.86 x 120.58 x 97.5 mm	
USB-87P2 (slot x 2)	124.60 x 120.58 x 97.5 mm	
USB-87P4 (slot x 4)	230.30 x 120.58 x 97.5 mm	
USB-87P8 (slot x 8)	254.30 x 120.58 x 97.5 mm	
■ Power		
Input Range	10~30 VDC	
Reverse polarity protection	Yes	
Isolation	3000 VDC	
Frame Ground	Yes	
Module	<i>Consumption</i>	<i>Power Board Driving</i>
USB-87P1	1 W	5 W
USB-87P2	1 W	8 W
USB-87P4	2 W	15 W
USB-87P8	2.4 W	30 W
■ Environment		
Operating Temperature	-25°C to +75°C	
Storage Temperature	-30°C to +85°C	
Humidity	5 ~ 95%, non-condensing	

# Chapter 2 Hardware Configuration

## 2.1 Install USB Driver

Before you setup the USB-87Pn, you must install USB driver.

Step1: Double click “USB-87Pn DriverInstaller.exe” to enter the installation screen

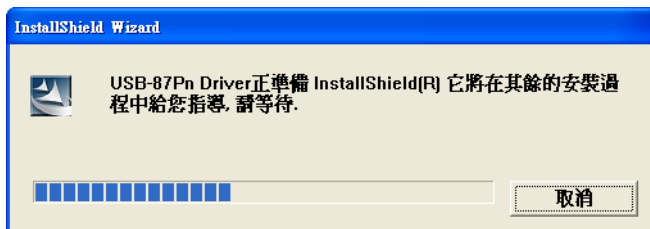

Step2: Click “下一步(N)>” to next step



Step3: Reading the license. If you accepted all of the license items, please click “是(Y)” to next step.

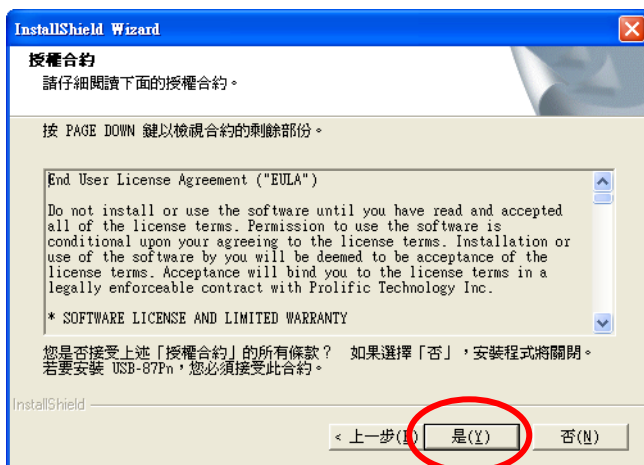

Step4: In “軟體安裝 (Software Installation)” screen, please click “繼續安裝(c)” to continue the Installation.



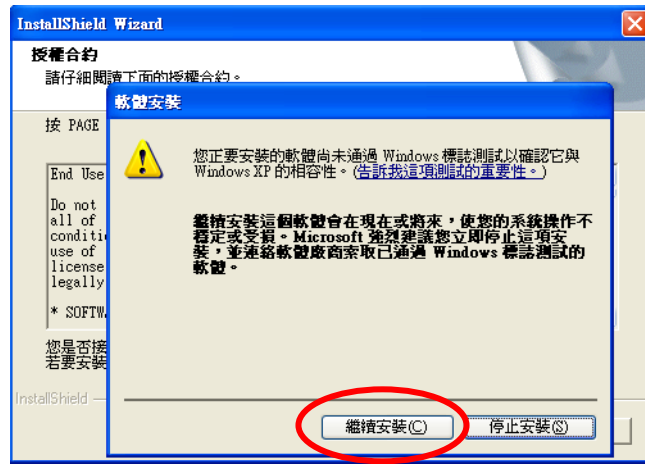

Step5: In this screen, you already finished the installation, please click “完成” to exit the program.



## 2.2 View of the USB-87PN

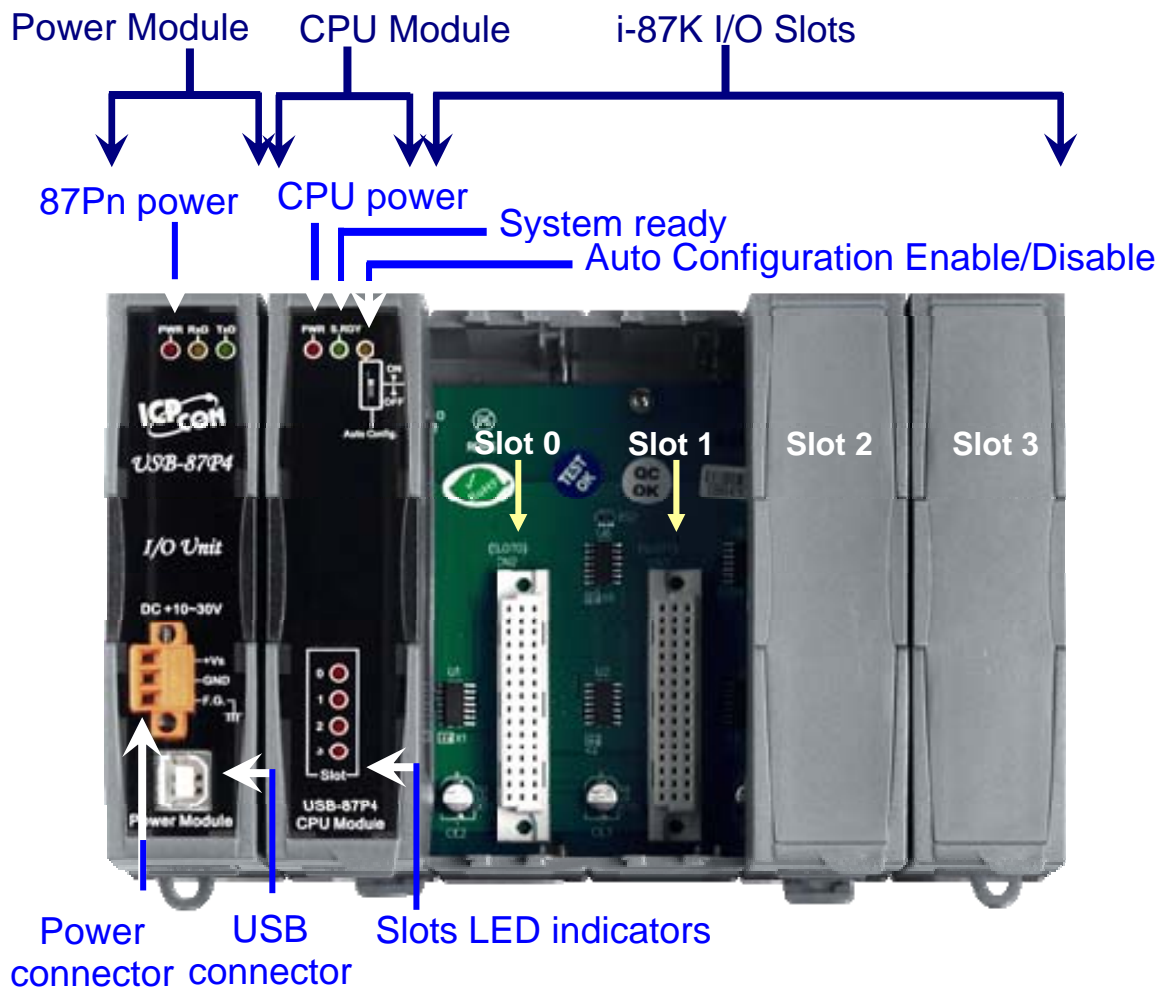

Fig.1 : View of 87Pn

### 2.2.1 Preparation

- ▶ Power Supply: +10V ~ +30V /DC (Ex: DP-665)  
[http://www.icpdas.com/products/Accessories/power\\_supply/power\\_list.htm](http://www.icpdas.com/products/Accessories/power_supply/power_list.htm)
- ▶ CA-USB18: USB connector cable (1.8M Cable)  
[http://www.icpdas.com/products/Accessories/cable/cable\\_selection.htm](http://www.icpdas.com/products/Accessories/cable/cable_selection.htm)
- ▶ Install the DCON Utility to PC (Version 4.5.2 or above version)  
CD: \Napdos\Driver\DCON\_Utility or  
[ftp://ftp.icpdas.com/pub/cd/8000cd/napdos/driver/dcon\\_utility/](ftp://ftp.icpdas.com/pub/cd/8000cd/napdos/driver/dcon_utility/)  
( Please removed the old version before installation)

## 2.2.2 Wire the 87Pn to power and PC

### USB-87P4

1. +Vs ⇔ Power Supply : +Vs (+10~30V)
2. GND ⇔ Power Supply : GND
3. CA-USB18 ⇔ PC's USB port

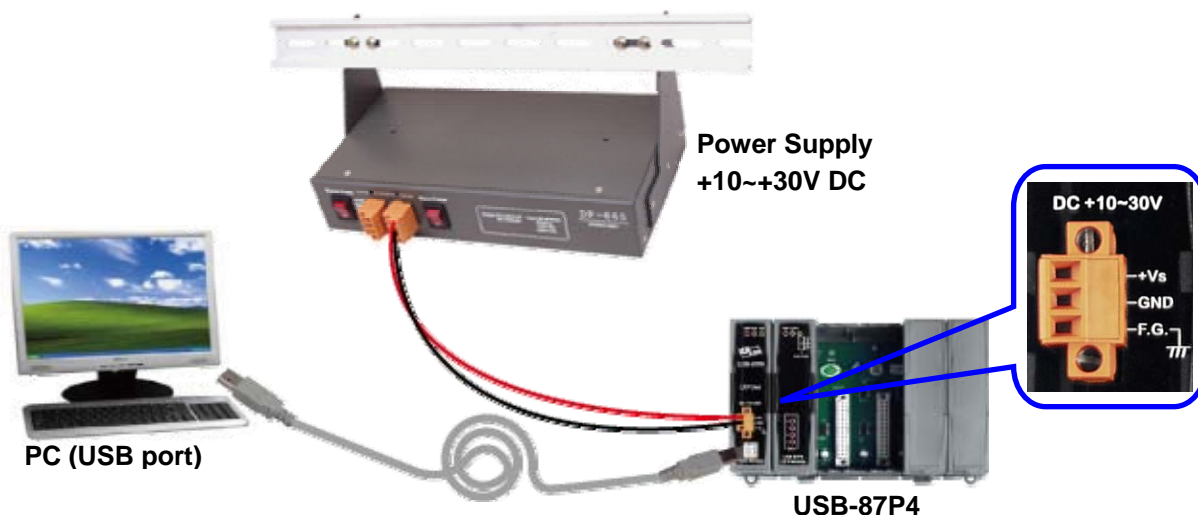

Fig.2 : Wire the 87Pn to power and PC

## 2.2.3 USB-87Pn's CPU module:

The factory default value is Auto Config. ON.

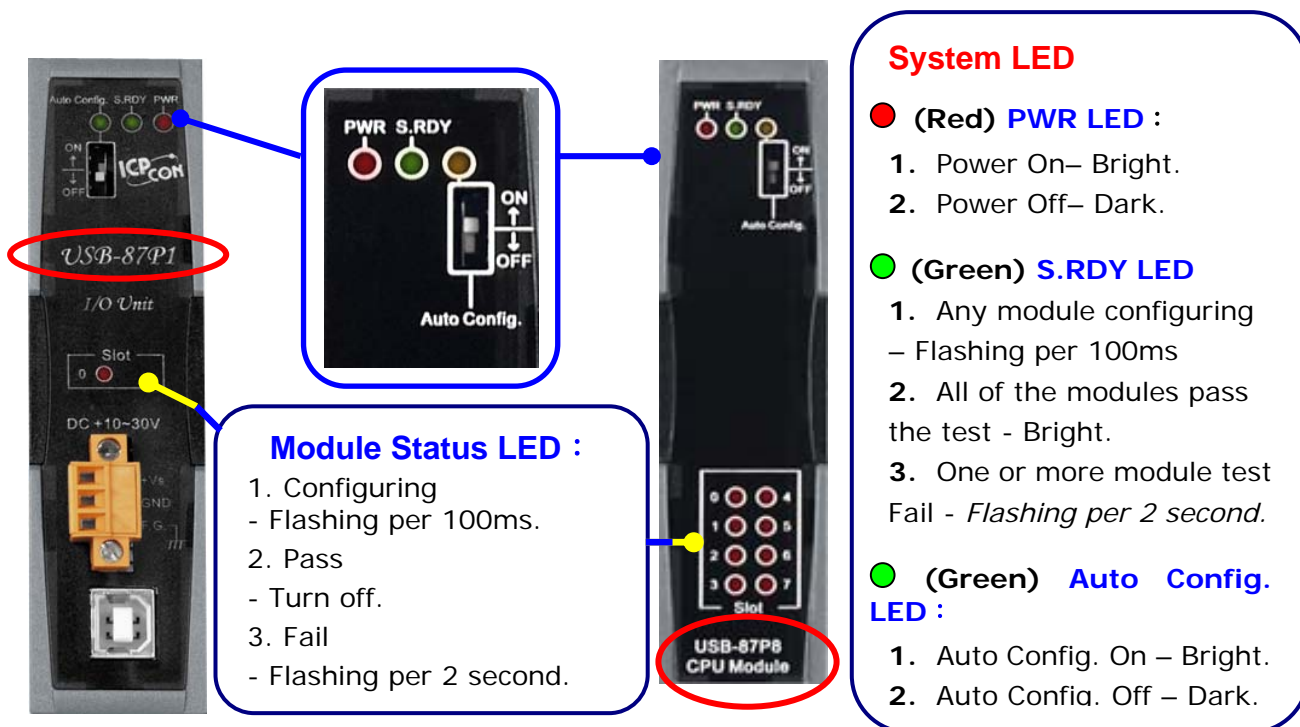

Fig.3 : 87Pn's CPU Module

## 2.2.4 USB-87Pn series CPU Module Description

**Check** the left side of the Power Board for the CPU module LED and Dip Switch description.

Default Setting					
Address	Baud Rate	Parity	Data Length	Stop bit	Checksum
01	115,200	None	8	1	Disable

USB-87P series CPU Board Description					
LED	Description	ON	OFF	Flashing (100ms)	Flashing (2sec)
S.RDY	System Ready	Ready	/	Configuring	Failure
Auto Config	Auto Configuration	Enable	Disable	/	/
Slot	Slot Status	/	Normal	Configuring	Failure



Fig.4 : USB-87P1/2/4/8 CPU module description

## 2.2.5 Plug in the I/O modules:

At present, ICPDAS divides most of the same i-87K I/O module into the Low Profile and High Profile two kinds of version, **if you want to use the module on 87Pn expansion slot, you must choose the High Profile** to assure “Auto Config.” and “Hot Swap” function is normal operation.

The related product information about i-87K I/O module is in the CD. You can refer i-87K High Profile series I/O modules in following path:

[CD:\Napdos\DCON\IO\\_Module\87k\\_modules.htm](CD:\Napdos\DCON\IO_Module\87k_modules.htm) or to following web-site

[ftp://ftp.icpdas.com/pub/cd/8000cd/napdos/dcon/io\\_module/87k\\_modules.htm](ftp://ftp.icpdas.com/pub/cd/8000cd/napdos/dcon/io_module/87k_modules.htm)

Example: Plug in i-87019R to Slot 0

p.s. i-87019R is an AI (Analog Input) High Profile module

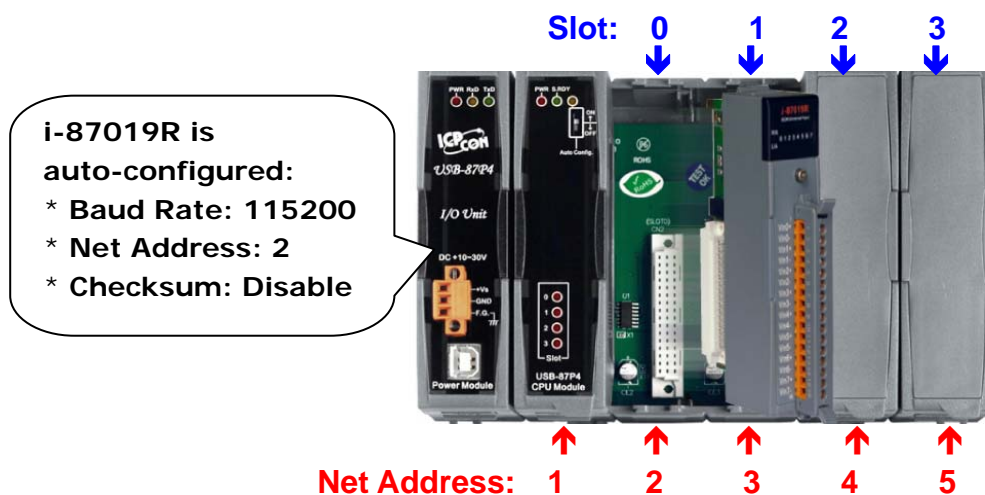

Fig. 5 : Plug in the I/O module

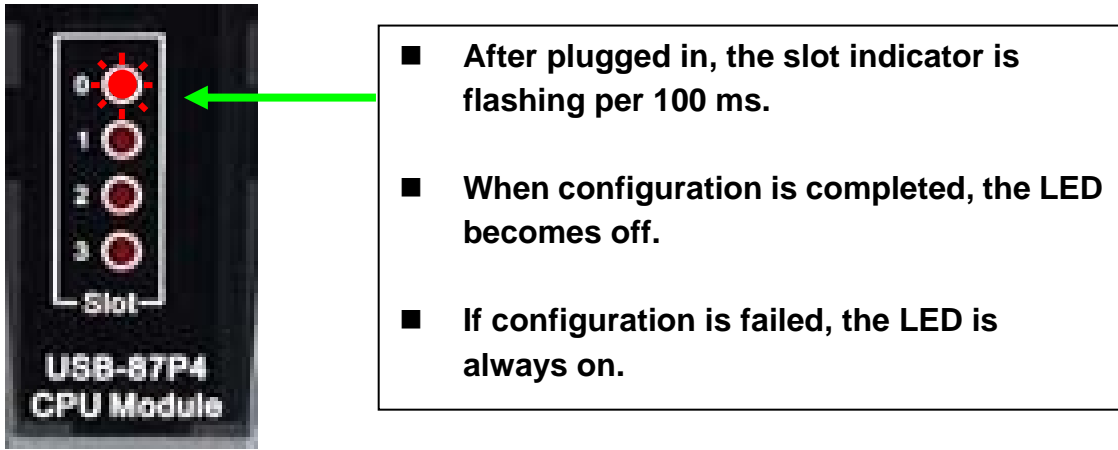

Fig. 6 : Description of LED indicator

### 2.2.6 Wiring the I/O modules:

Before wiring the i-87K I/O modules, please check the pin assignment and wiring according to each hardware user manual.

For each i-87K I/O module's hardware user manual please refer to [CD:\Napdos\DCON\IO\\_Module\87k\\_modules.htm](CD:\Napdos\DCON\IO_Module\87k_modules.htm)

According to the internal circuitry diagram and wire connection diagram, please connect the power cable or communication cable to each channel on terminal block of I/O module.

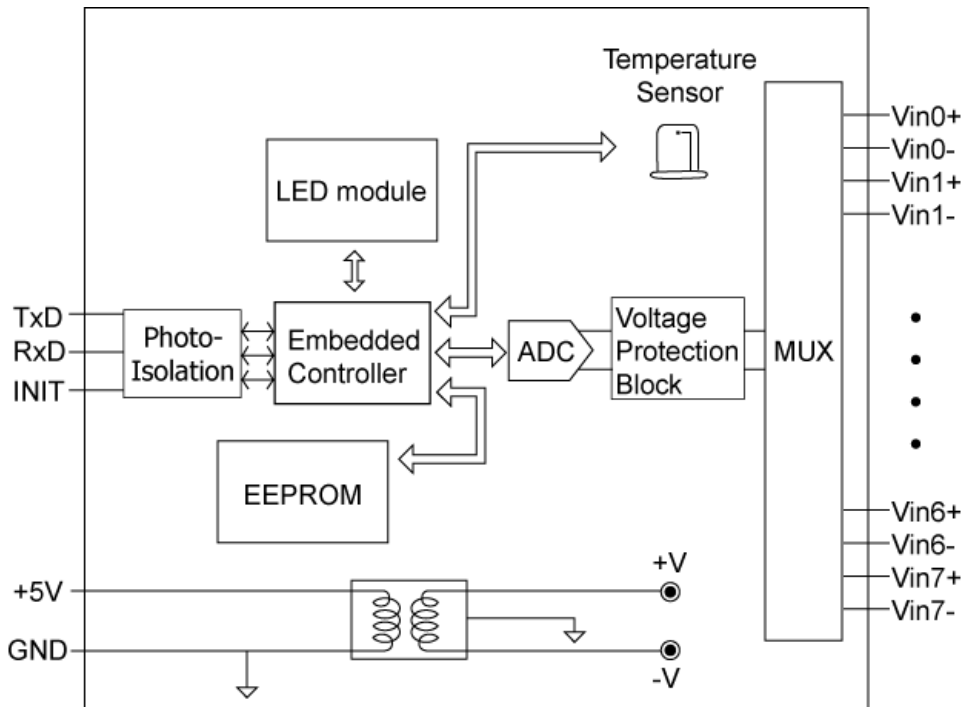

Fig. 7 : i-87019R - Internal I/O structure

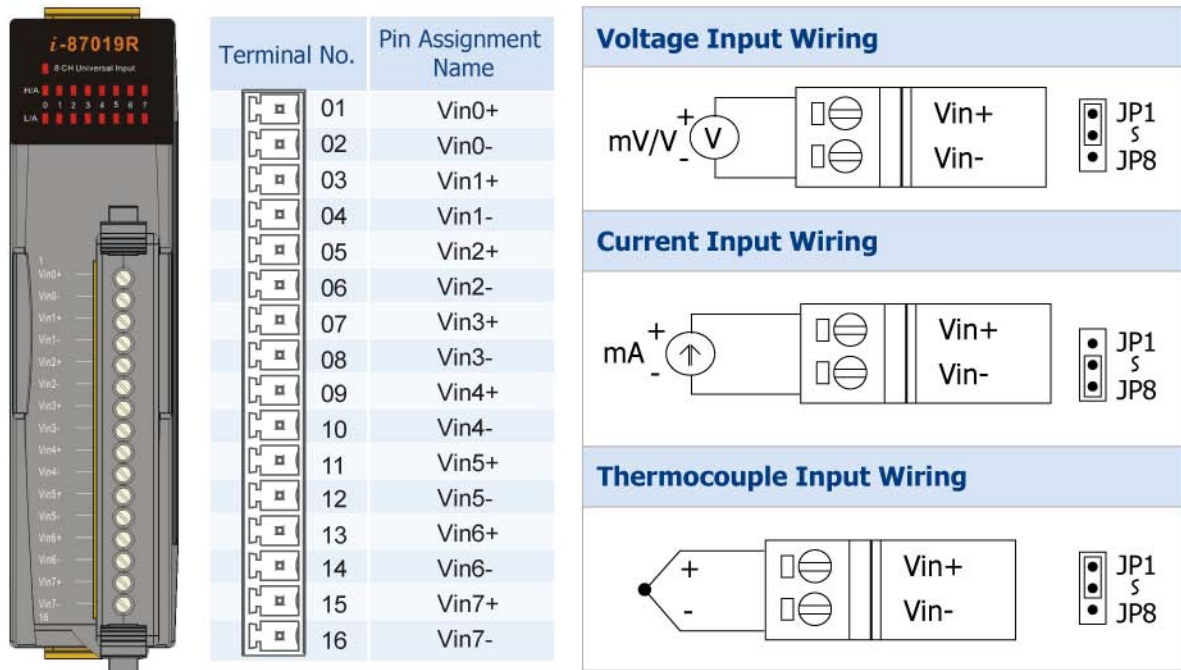

Fig. 8 : i-87019R - Pin assignments & Wire Connection

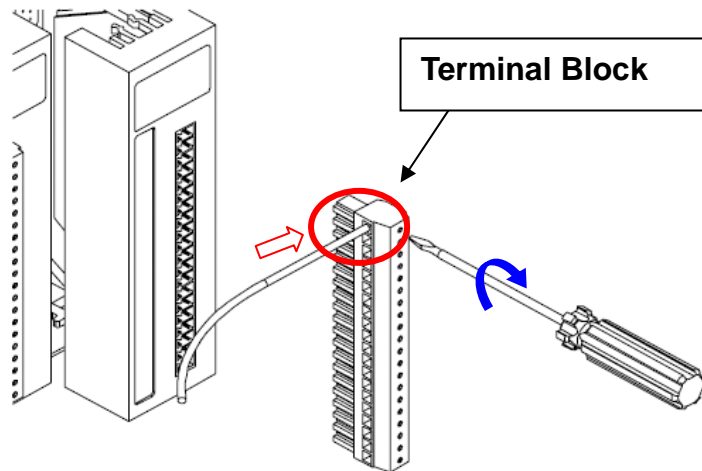
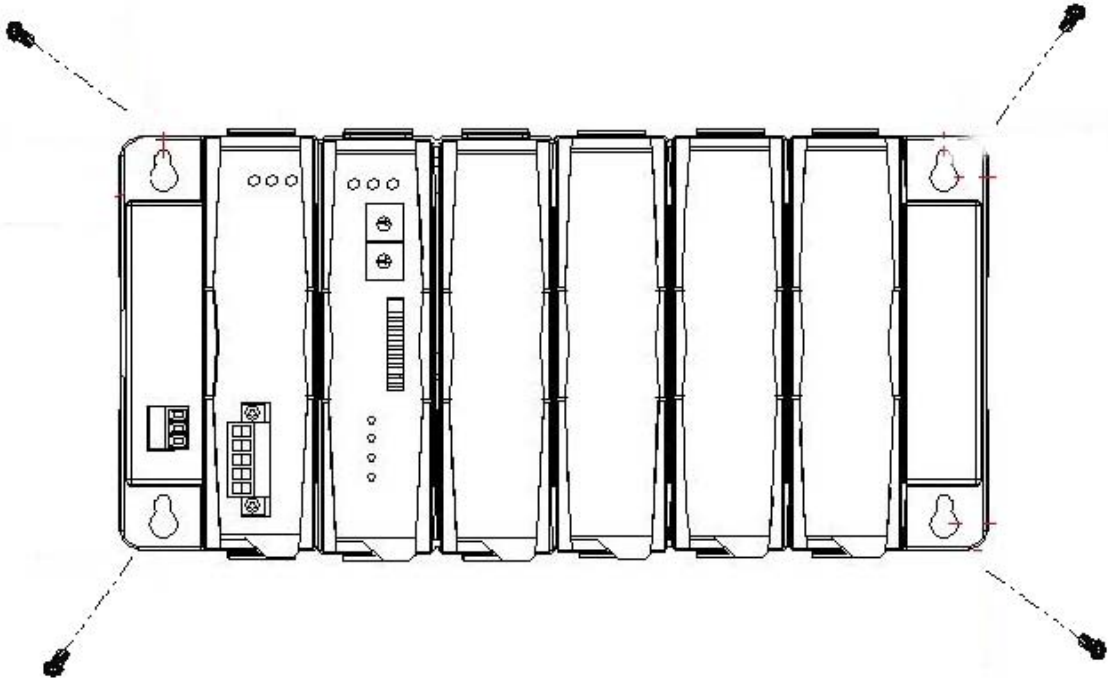

Fig.9 : I/O module terminal connection

## 2.2.7 Installing USB-87Pn extension unit

Method 1: using the screw to fixed.



Method 2: using the DIN rail clips to fixed.

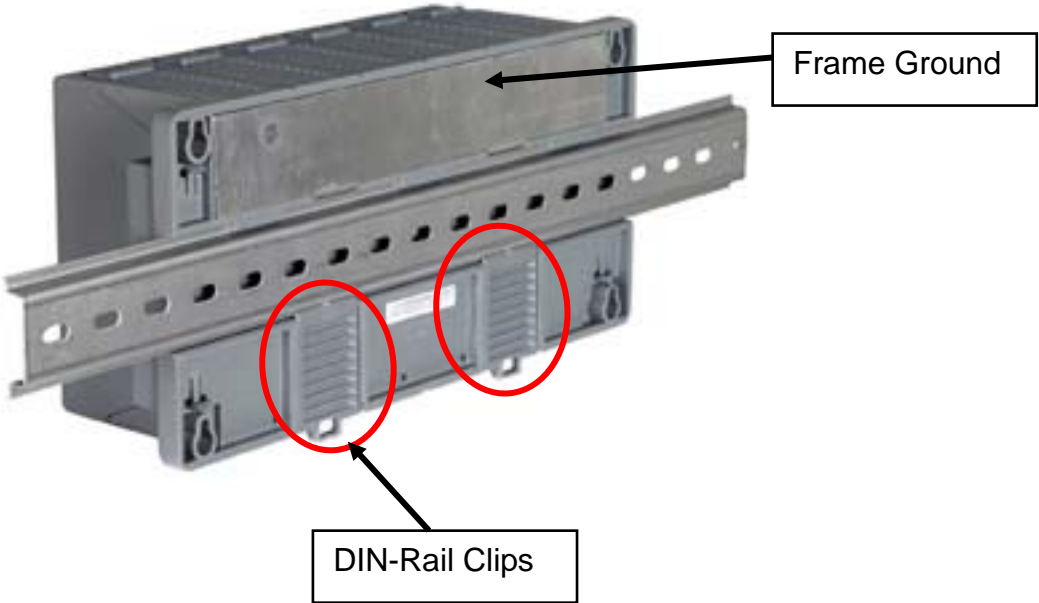

Fig.10 : Installing USB-87Pn extension unit

# Chapter 3 Software Configuration

In this chapter, we will use DCON Utility to complete software configuration of the USB-87Pn, please confirm the hardware equipment has connected and 87Pn CPU module has setup completes. (Please refer to [Chapter 2](#))

- 3.1 [Setup USB-87Pn with DCON Utility](#)
- 3.2 [Save & Load 87Pn configure file](#)
- 3.3 [Load & Write configure file](#)
- 3.4 [Operating in off-line mode](#)

## 3.1 Setup USB-87Pn with DCON Utility

At first, please run DCON Utility then click “COM Port” to select COM port and baud rate. You can check your PC’s “Device Manager” to know which COM is connecting. Click “OK” to confirm and escape the screen.

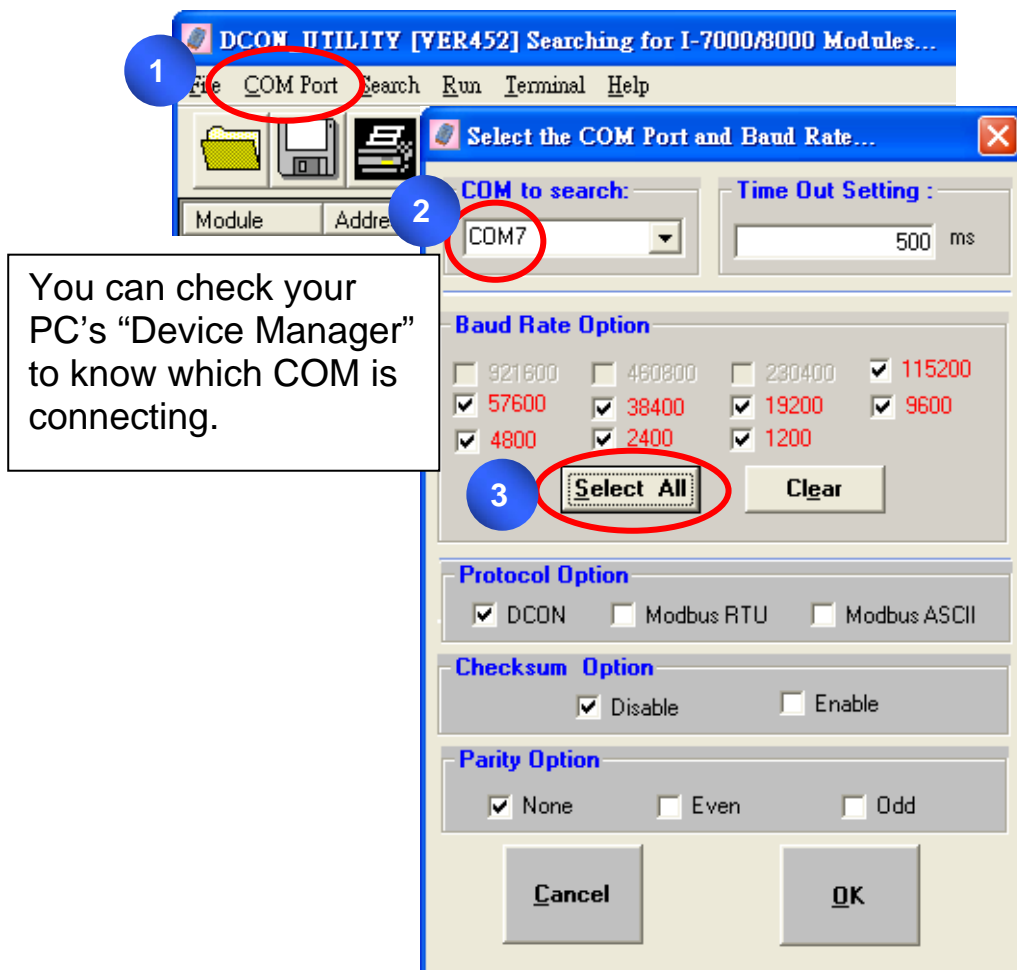
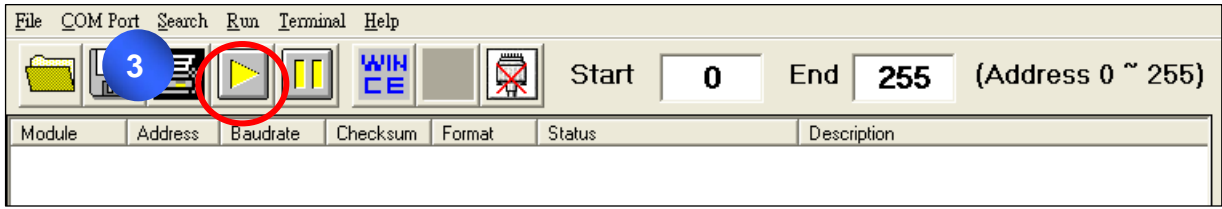

Fig. 11 : Run Dcon Utility and search 87Pn





Please click “start search” button to search.

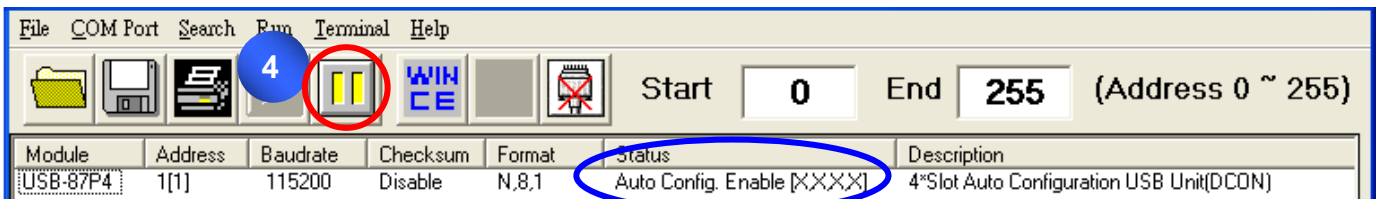

At the first time you can search for “USB-87Pn” only, because the slots of USB-87Pn haven’t completed the configuration. The “[X,X,X,X]” of “Status” means the configuration of that slot is not completed or corrected.

Please click “stop search” to stop the search.



When found USB-87Pn, click  to stop search. “[X,X,X,X]” of “Status” means the configuration of that slot is not completed or corrected.

Click “USB-87Pn” and open the “Configure Module” screen to step.

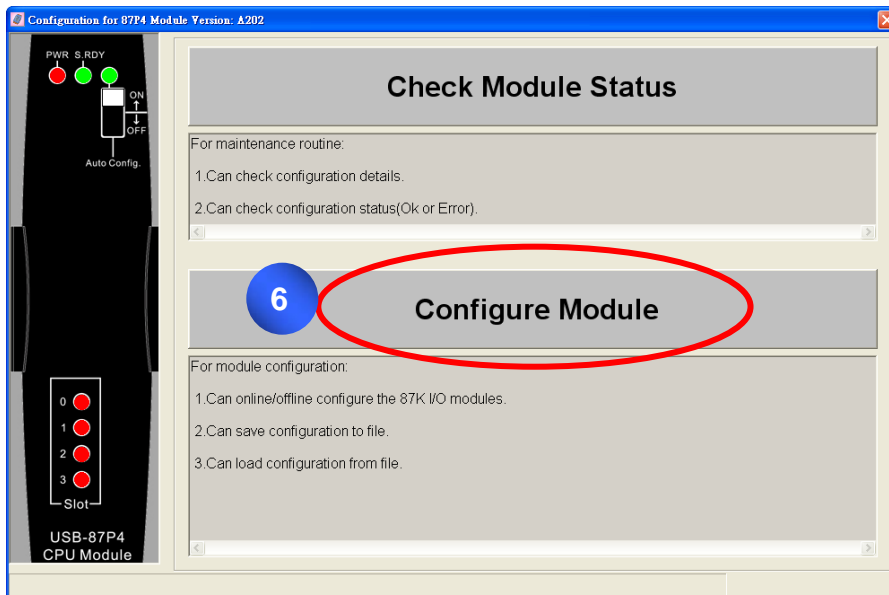
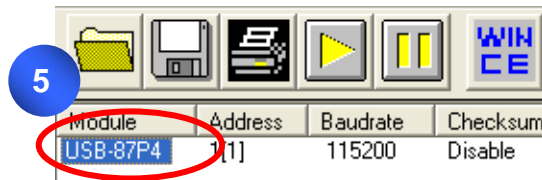

### 3.1.1 87Pn Auto Config. Enable:

"Auto Config. ON" expressed that the 87Pn's Auto-Configuration function is "enable", "off" means "disable".

#### Working Distinction:

If i-87K I/O modules didn't pass the 87Pn correct setup, and install into expansion slot under "Auto Config. Enable" mode, it will regard as incorrect module. For guarantee system's normal operation, the 87Pn will forbid this module external communication. You can't search and configure I/O modules directly by DCON Utility.

The "Auto Config. Enable [X,X,X,X]" in Status column, means the module configuration of that slot is not completed or corrected. Click "USB-87P4" and select "Configure Module" to enter configure screen and know the detail settings about module.

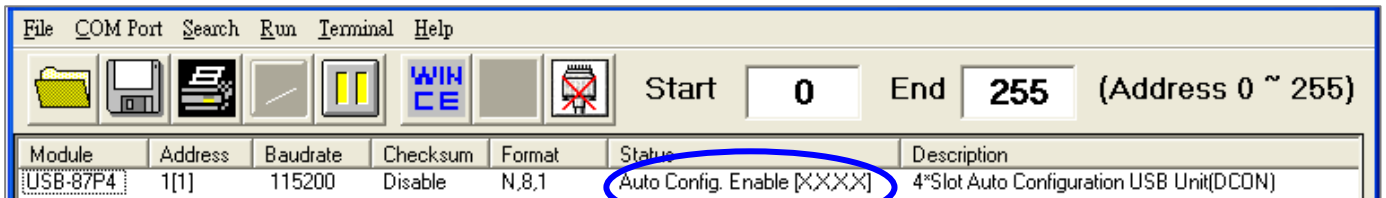

Fig.12 : Auto Config. Enable, setup the 87Pn

In 87Pn configure screen, you can see the scanned module name in "Scanned I/O on Slot" column. Click "Set As Scanned" button to assign module name and click "configure" to setup the I/O module according to the user demand. Finally click "write to 87Pn" for the settings to take effect.

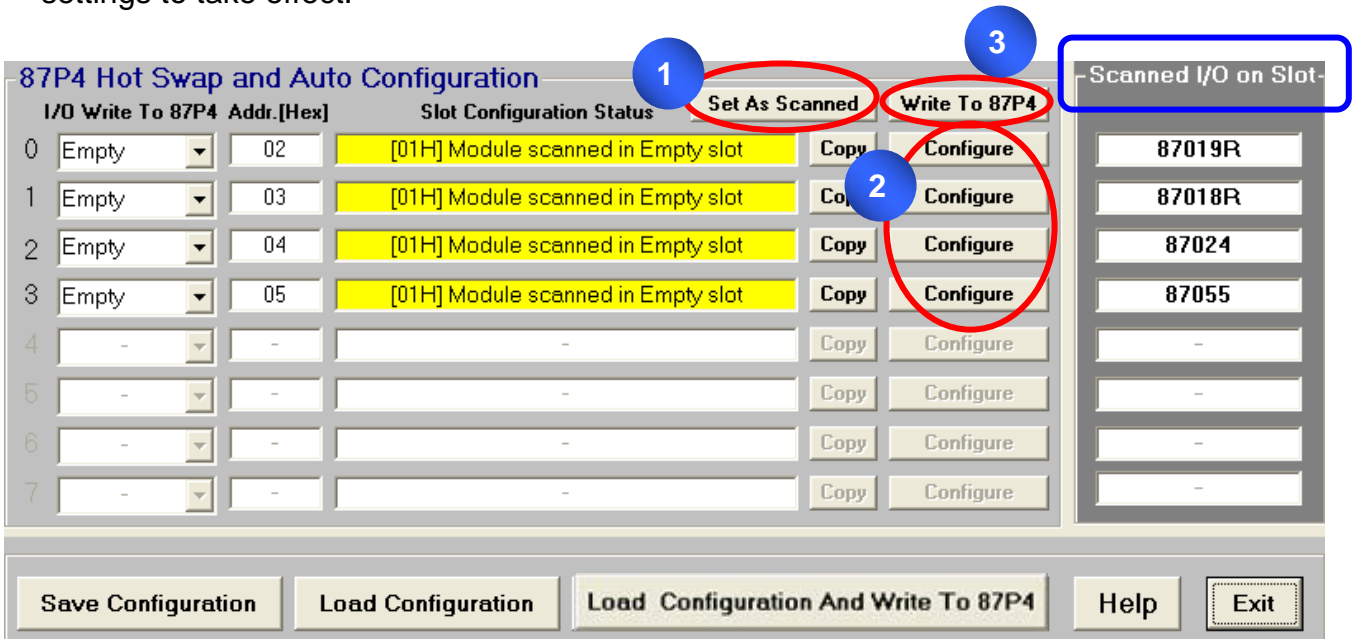

Fig.13 : Follow 3 steps, write the settings to 87Pn

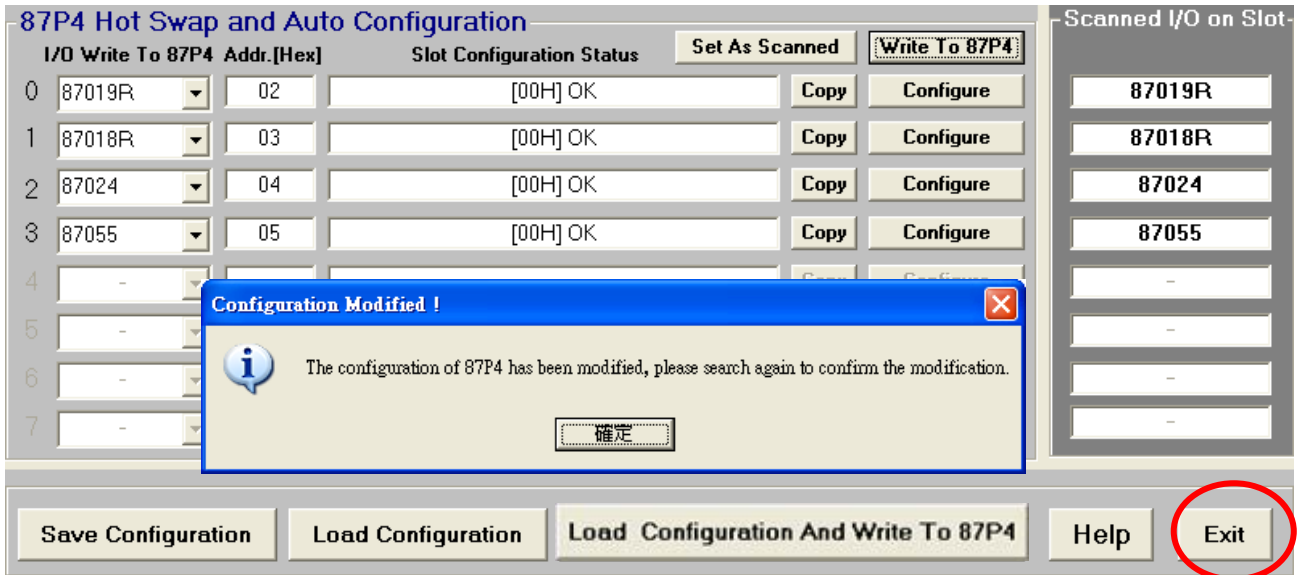

Fig.14 : Complete the 87Pn configuration then search again

As above, all the settings for each modules has configured correctly by "DCON Utility", and then search the module again, you can see each plugged I/O module name will be listed under the screen.

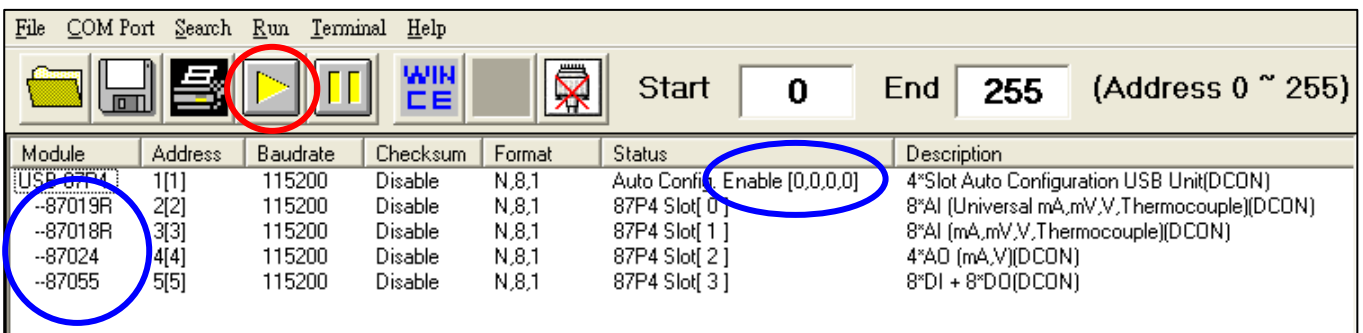
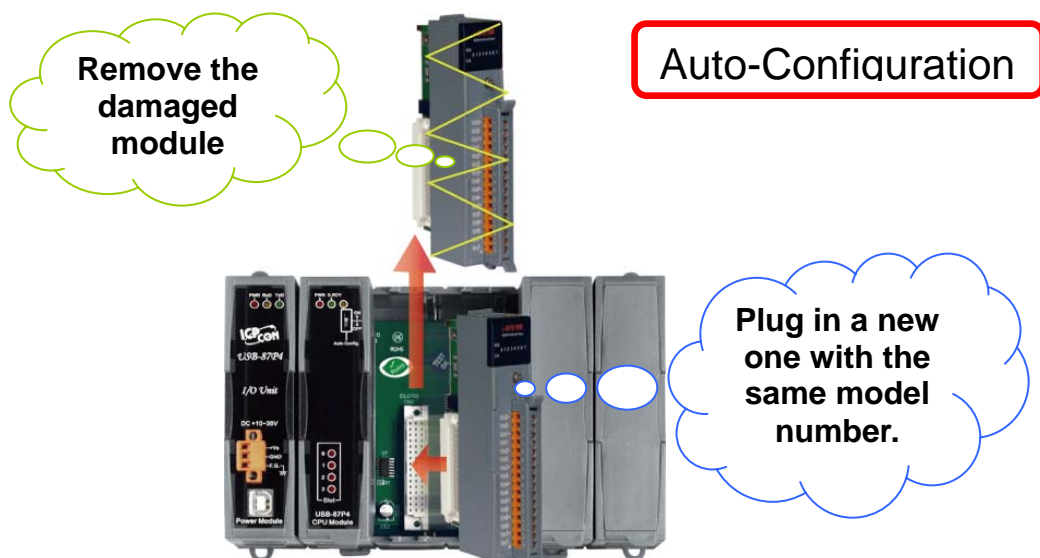

Fig.15 : After configuring, you can find out the entire module

The "Auto Config. Enable [0,0,0,0]" of "Status", means "The I/O configuration of each slot is correct. If module is damaged, you don't need to shutdown the power, just remove the damaged one and install the same model number of new module. 87Pn will write the previous settings to the module automatically.



## 3.1.2 87Pn Auto Config. Disable:

### Working Distinction:

In 87Pn Auto Config. Disable mode; allow the i-87K I/O modules to external communications even you haven't completed the configuration. Therefore, when you perform searching by DCON Utility, you could find 87Pn CPU module as well as 87K I/O modules on the expansion slot. But you can't click "USB-87P4" to setup the modules in this mode.

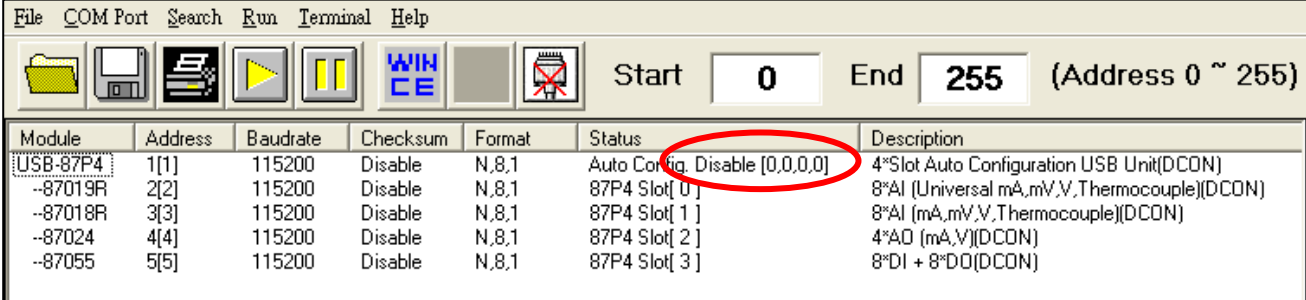

Module	Address	Baudrate	Checksum	Format	Status	Description
USB-87P4	1[1]	115200	Disable	N,8,1	Auto Config. Disable [0,0,0,0]	4*Slot Auto Configuration USB Unit(DCON)
--87019R	2[2]	115200	Disable	N,8,1	87P4 Slot[ 0 ]	8*AI (Universal mA,mV,V,Thermocouple)(DCON)
--87018R	3[3]	115200	Disable	N,8,1	87P4 Slot[ 1 ]	8*AI (mA,mV,V,Thermocouple)(DCON)
--87024	4[4]	115200	Disable	N,8,1	87P4 Slot[ 2 ]	4*AO (mA,V)(DCON)
--87055	5[5]	115200	Disable	N,8,1	87P4 Slot[ 3 ]	8*DI + 8*DO(DCON)

Fig. 16 : When 87Pn Auto Config.: Disable, all the module can external communication

In 87Pn "Auto- Config. Disable" mode, doesn't support Auto-Configuration. When the module damaged and replaces another module with the same model number directly. It may be doesn't work well, because of their settings (e.g. Type code) is different. The user must use DCON Utility to re-configure the settings, and replies the normal operation.

**Note** : In DCON Utility search screen, the message in status column of 87Pn

**The meaning of " Auto Config. Enable [0,X,0,0] " as following description :**

**0** : Means the module configuration on this slot is successful or have no module.

**X** : Means the module configuration on this slot is uncorrected.

If the status column of 87Pn shows "Auto Config. Enable [0,0,0,0]", means the "Auto Config." of Dip Switch is switching to the "On", and the I/O configuration of each slot is correct or has no module.

If the status column of 87Pn shows "Auto Config. Disable [0,0,0,0]", means the "Auto Config." of Dip Switch is switching to the "Off", and the I/O configuration of each slot can initialization success or have no module.

## 3.2 Save & Load 87Pn Configure file

When you completed the module configuration, you can press "Save Configuration" to save all the settings of related modules. it can be use for system recover and system backup. In addition, you can press "Load Configuration" to load the prior configuration file. The related format and detail about configure file, please refer to **Appendix D**.

### 3.2.1 Save the Configure file:

When all modules has configured properly, you could save the settings as a file to avoid the settings is carelessly changed or need to duplicate the same content of configure. You can refer [3.1.1](#) to configure the modules.

The operation steps is very easy, you check or modify the settings of each I/O module by click "Configure" button, then click "Save Configuration" button and input the description or notes for this configuration file. Finally, input the file name of this project to complete. Please refer to the description as following diagram.

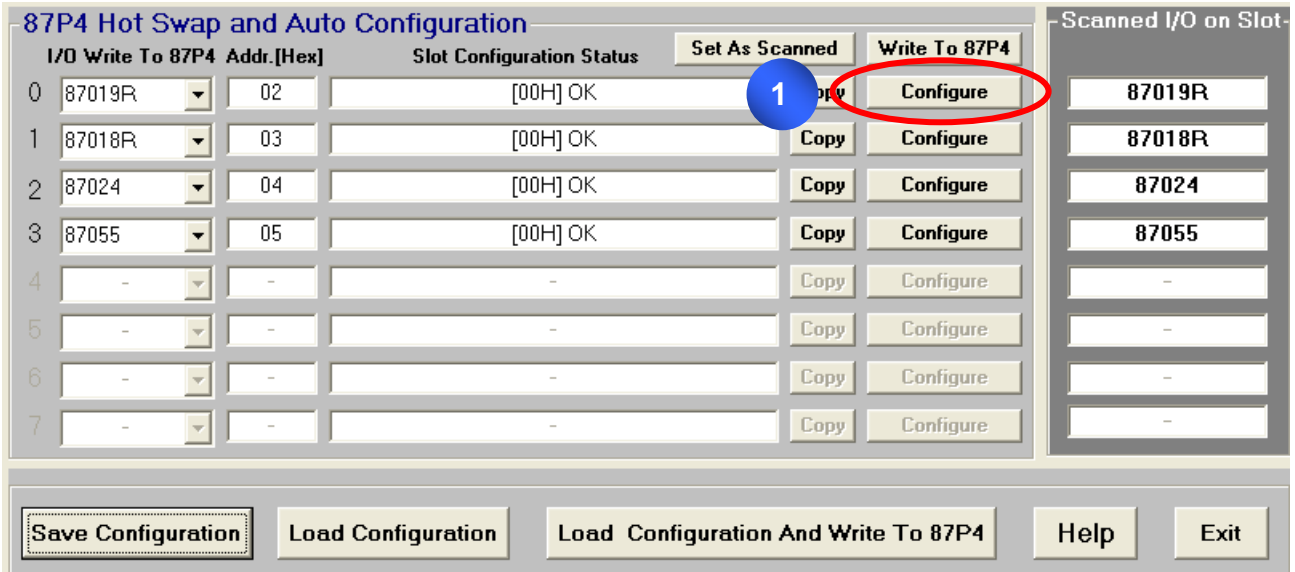
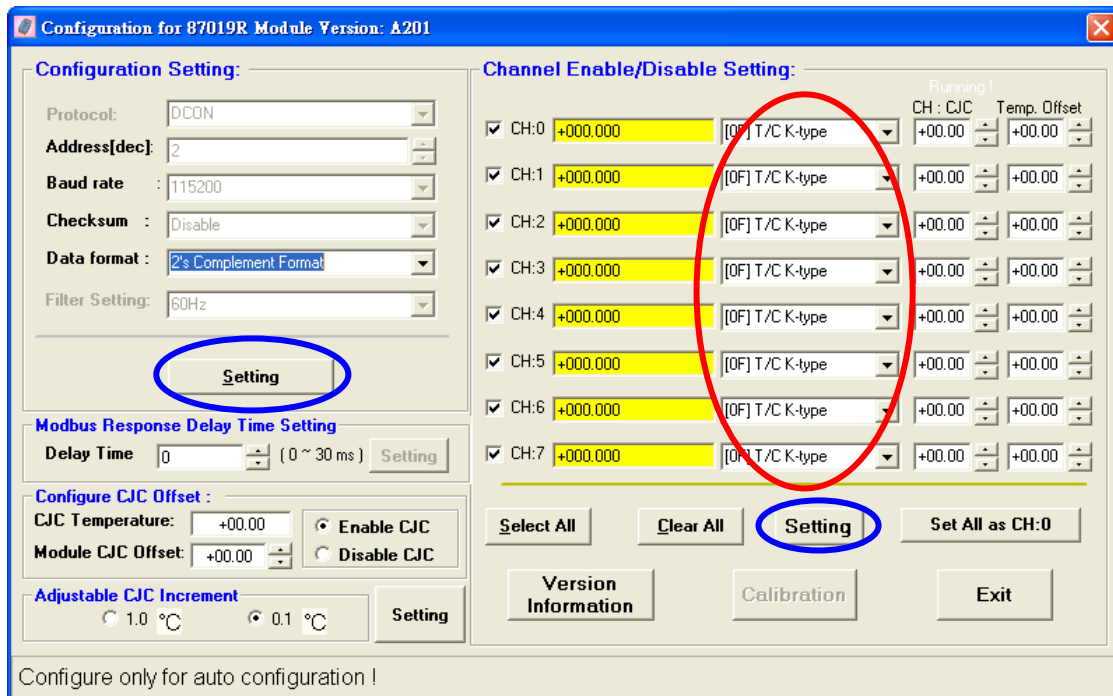
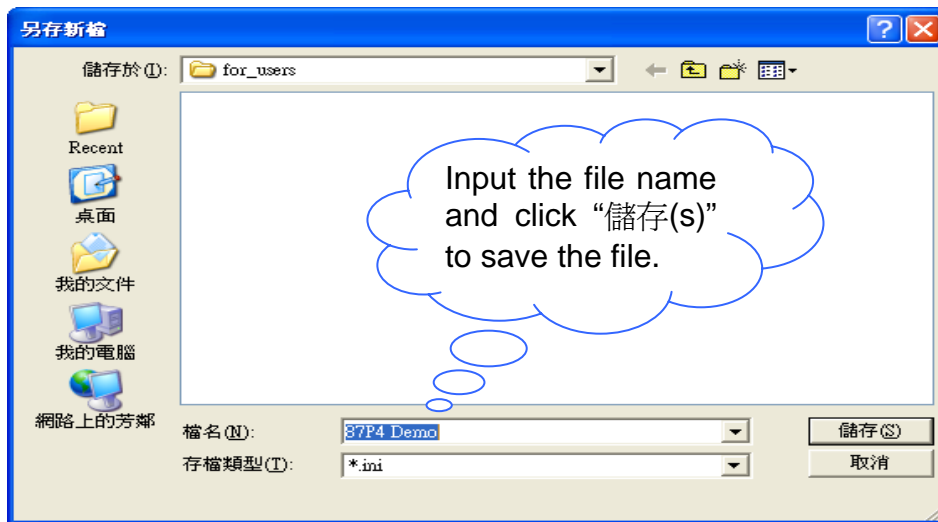
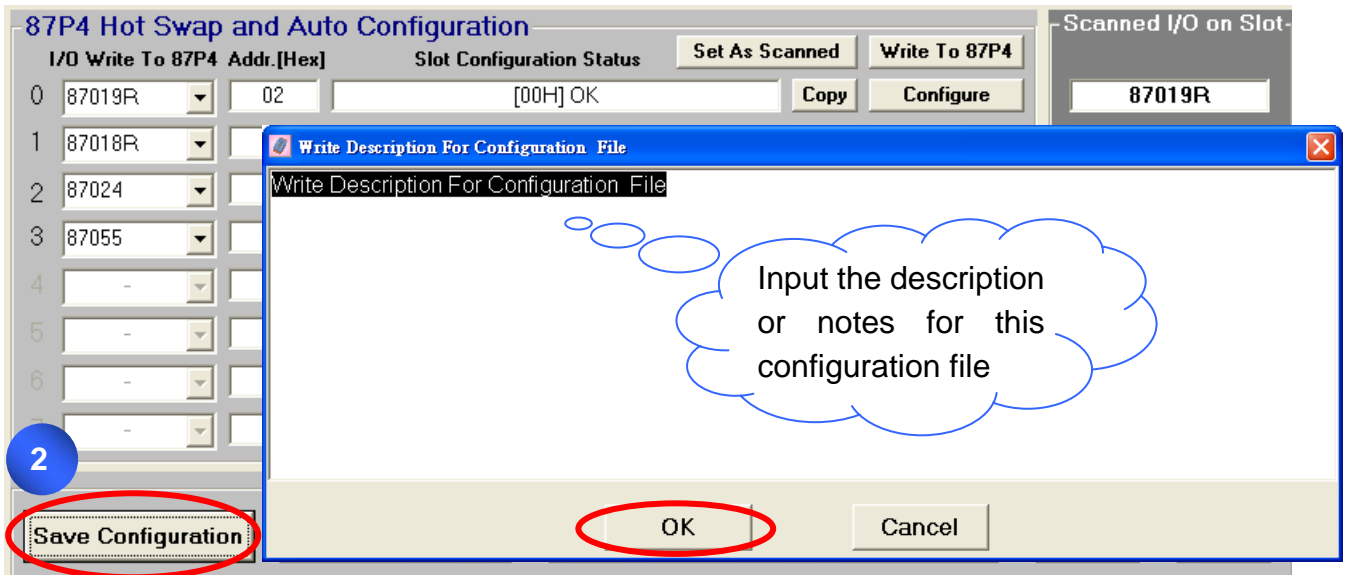

Fig. 17 : Save the configuration file



**Note:** When you change the settings, please click "Setting" to confirm.



### 3.2.2 Load the Configure file

You can use this function when you want to duplicate the same settings to other USB-87Pn or load the prior configuration file in the same USB-87Pn. At first, please click “Load Configuration”.

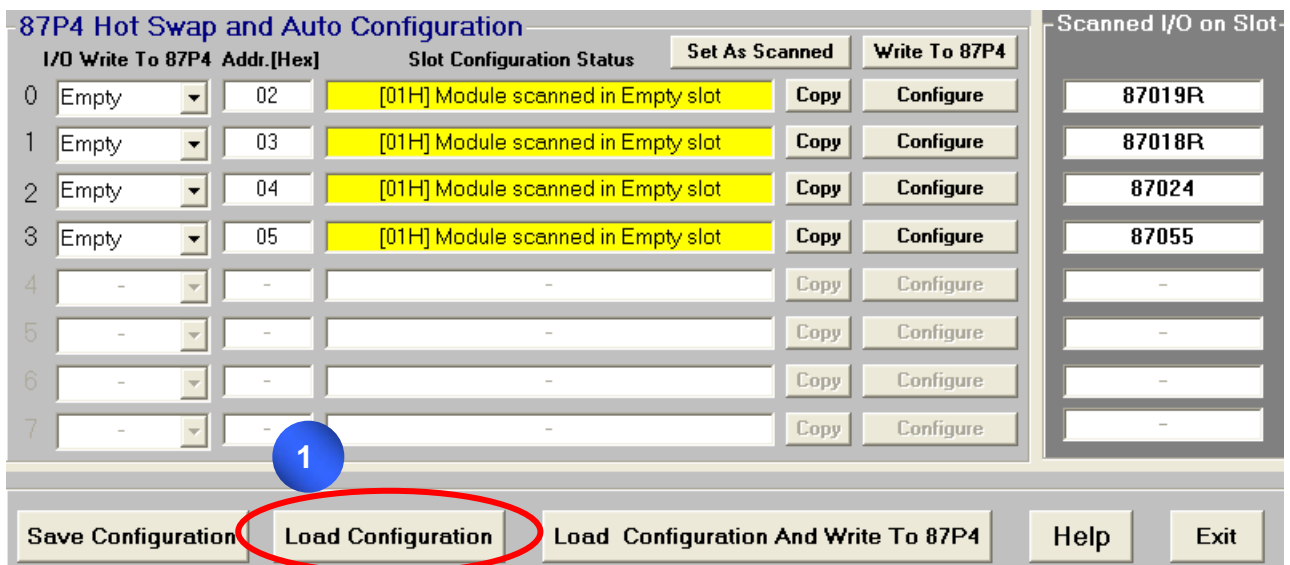
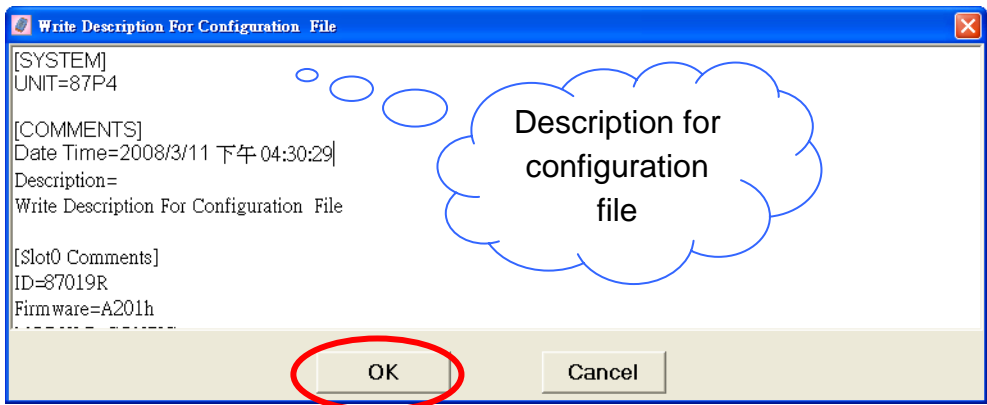
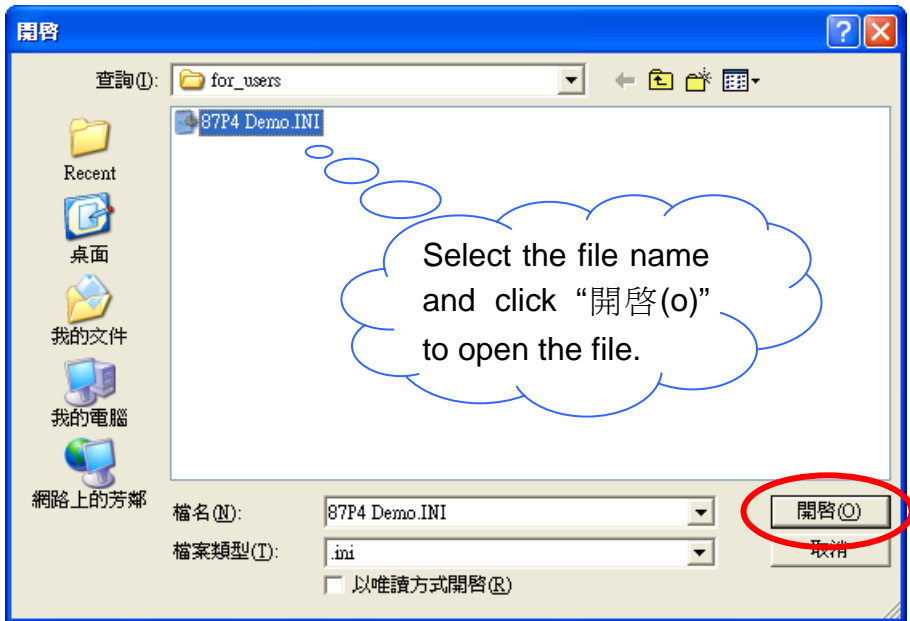
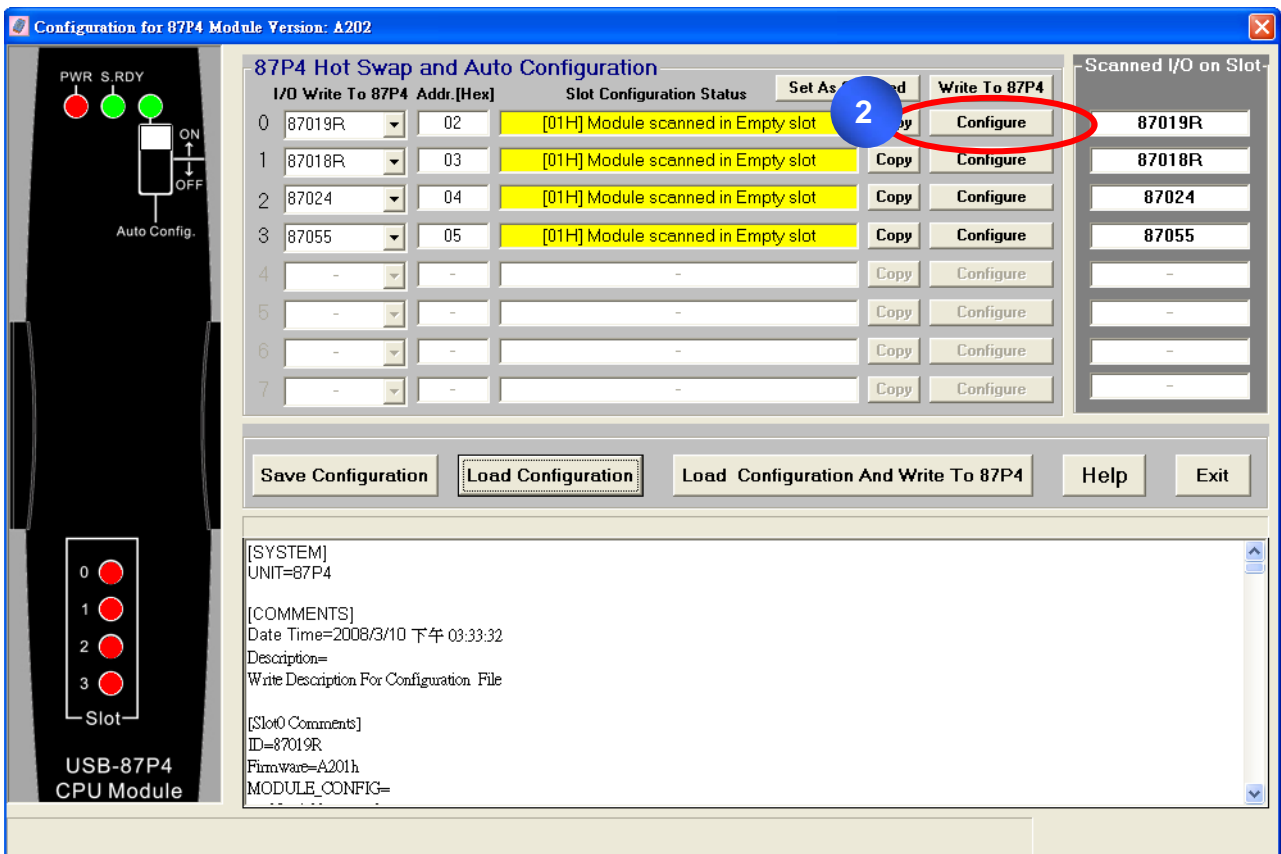

Fig. 18 : Load the configuration file



Click “Configure” to check whether the settings of each module are correct.



Click "Write To 87P4" to write the configuration to 87Pn CPU module.

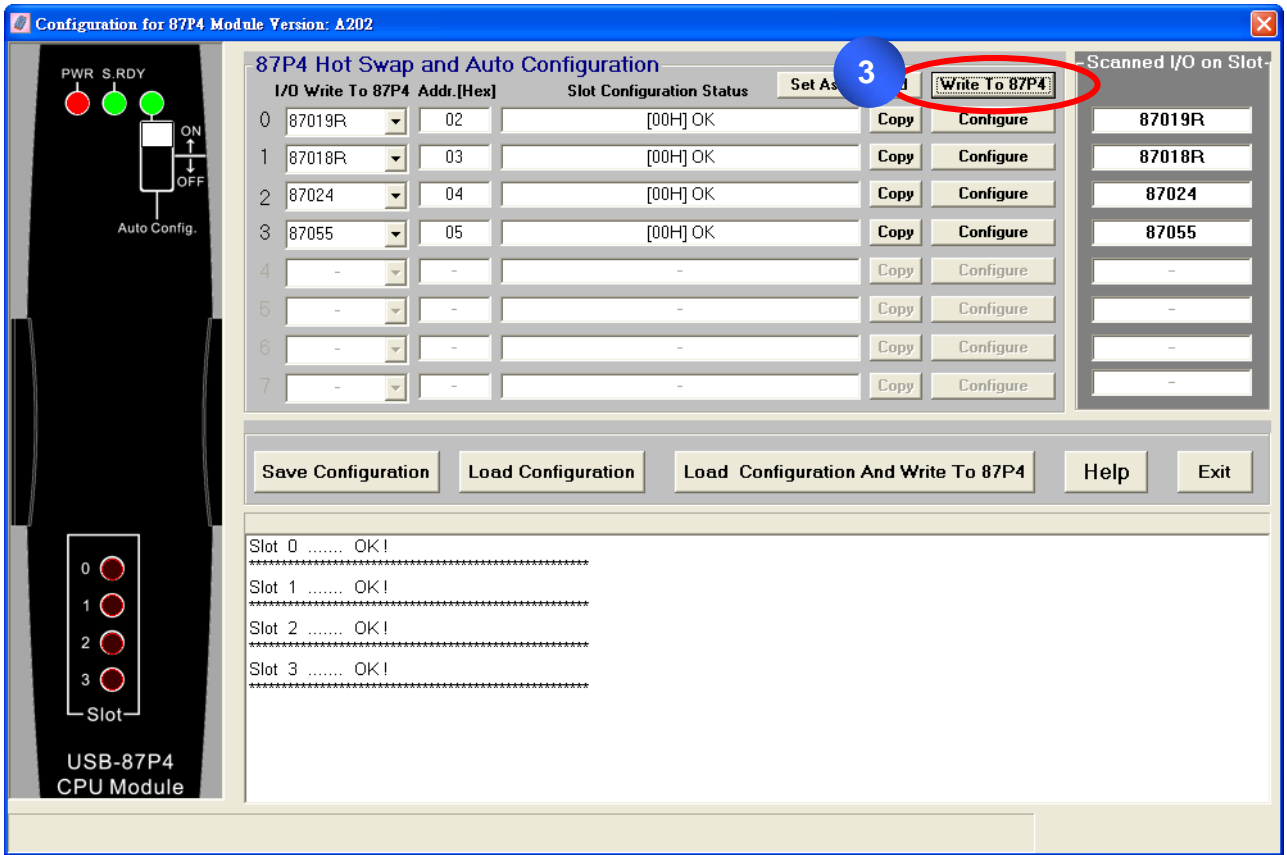

### 3.3 Load & Write the configure file

If you sure the contents of configure files is what you need, you can load the configuration and write to 87Pn at the same time. As following diagrams, this function is useful for a lot of copy to other 87Pn. Click " Load Configuration And Write To 87P4".

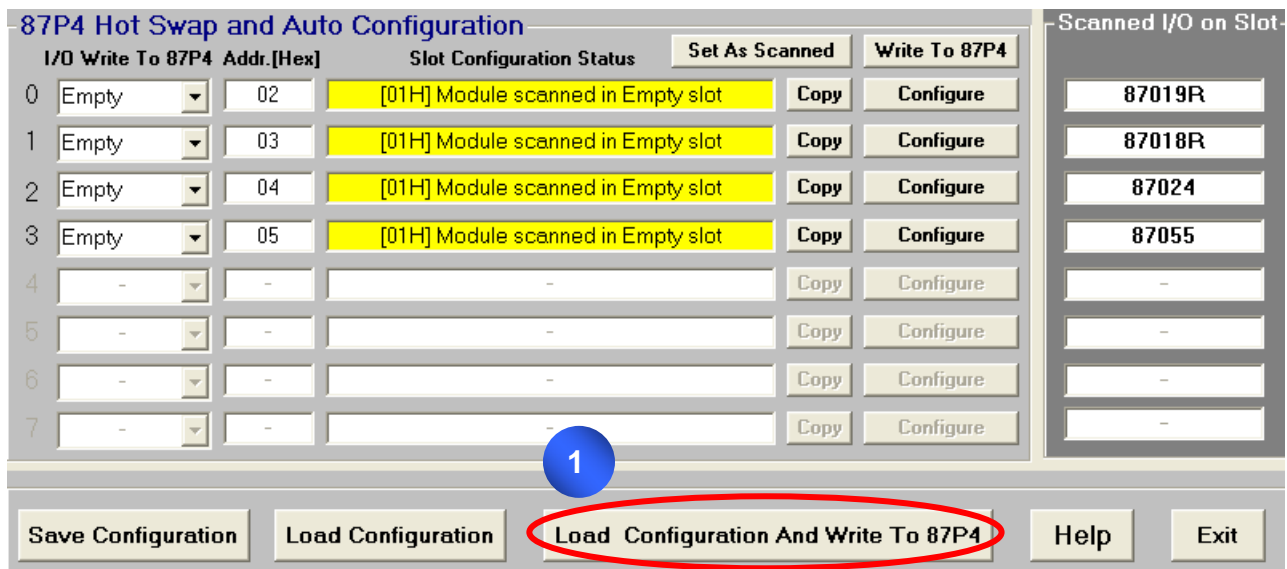
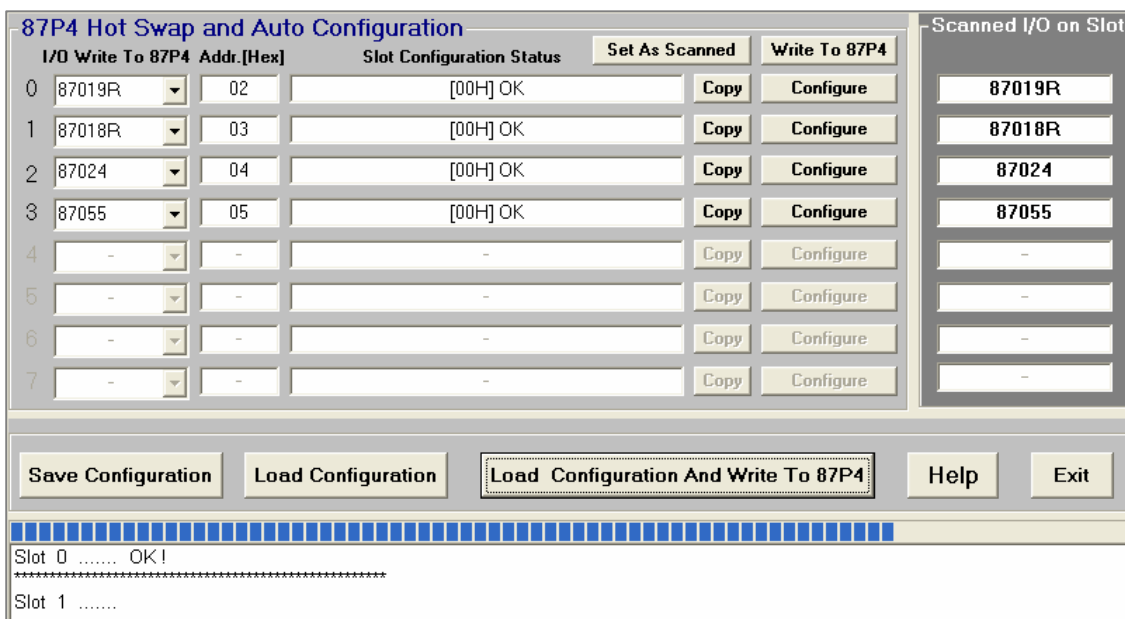
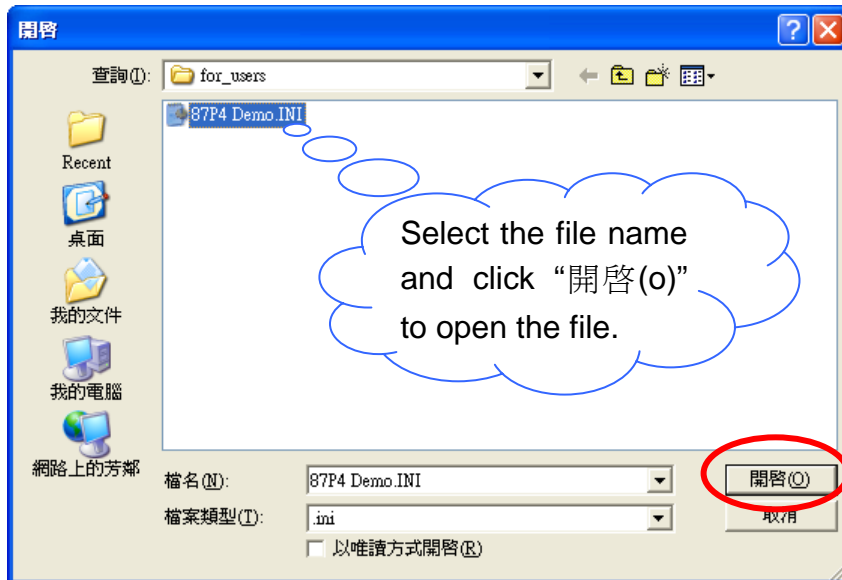

Fig. 19 : Load & Write the configuration file





### 3.4 Operating in off-line mode:

When you want to use Docn Utility to configure the modules, but your computer did not connect any USB-87Pn. You can configure the settings and save the configuration file in off-line mode.

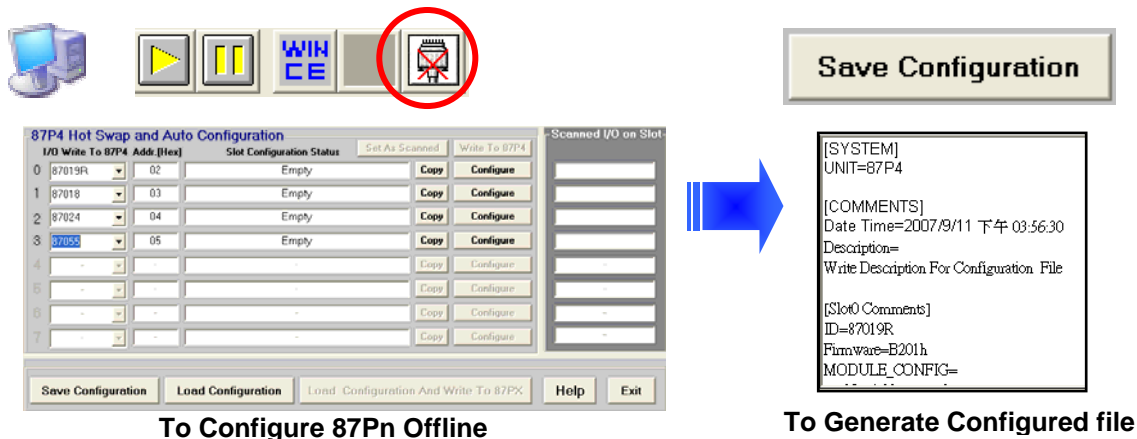

To Configure 87Pn Offline

To Generate Configured file

Fig. 20 : Configure and save file in off-line mode

And then you can copy the file to another computer which connected with 87Pn. Run the DCON Utility and enter “configure module” screen. You can click “Load Configuration And Write To 87P4” to write the settings to 87Pn, this usage is convenient for remote support or system backup.

**Note:** The configure file will be save to C:\ICPDAS\DCON\_Utility\for\_users

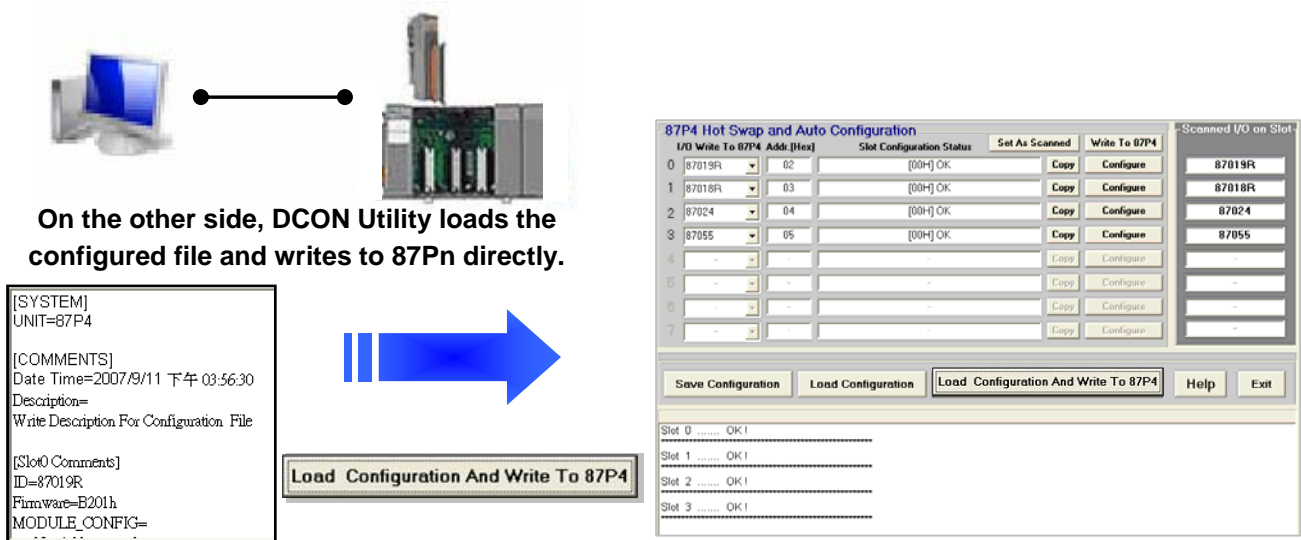

Fig. 21 : Load & write Configuration file through other PC

Follow the steps, you can setup & save the configuration file without connected 87pn and then write this file to any 87Pn.

**Step1 :** Click off-line button and select the Module ID, Address, Baudrate and Checksum.

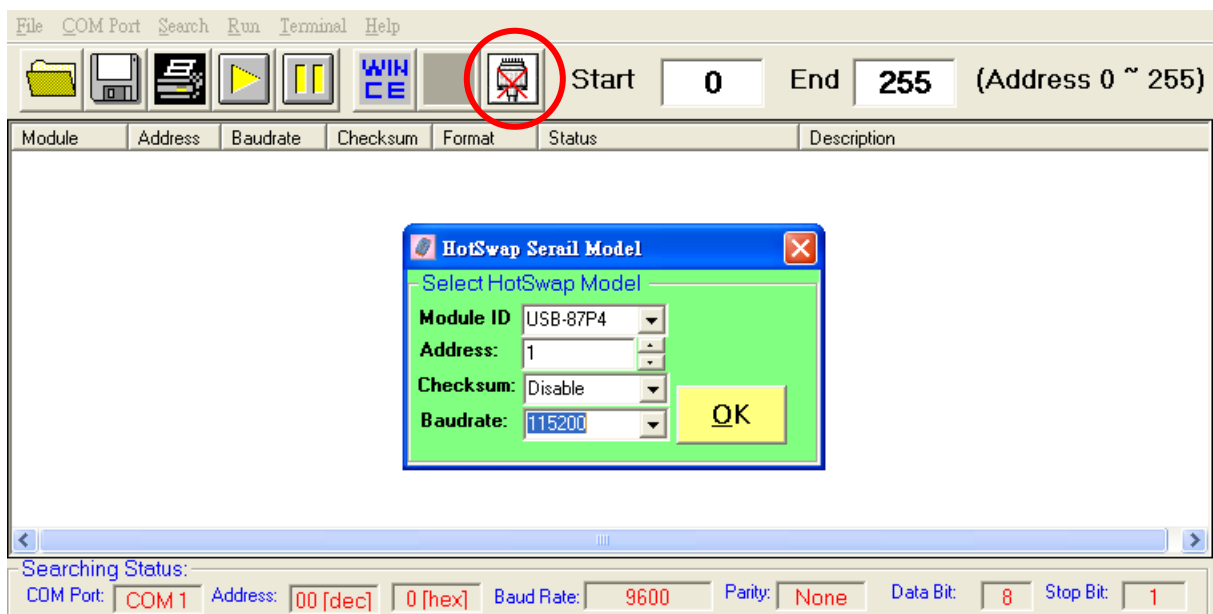
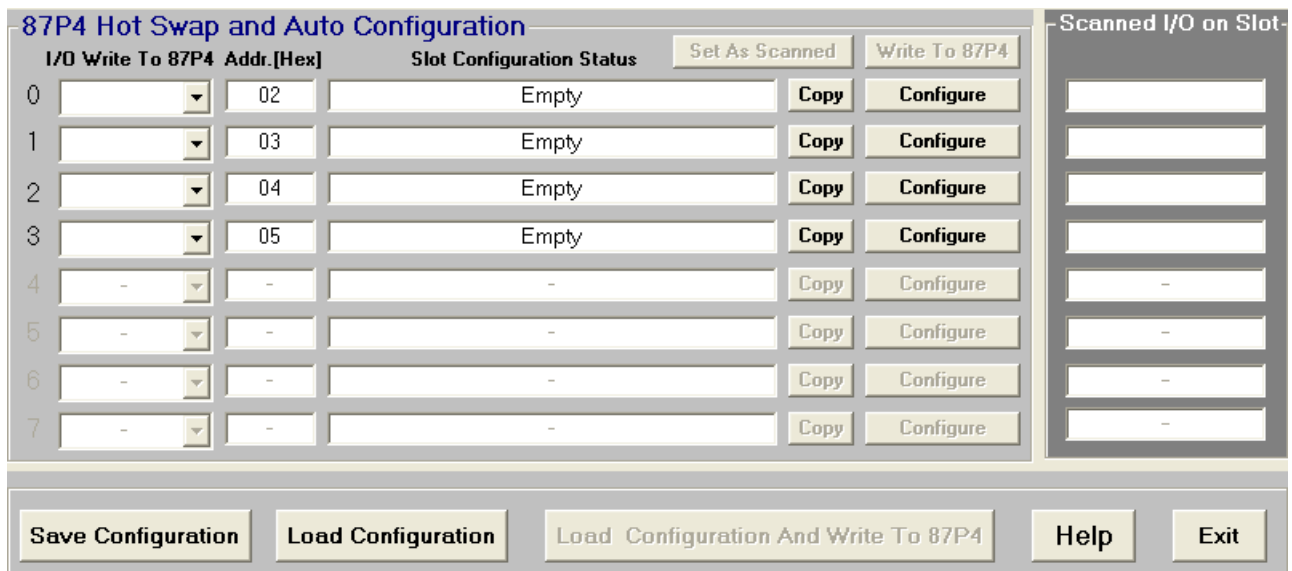
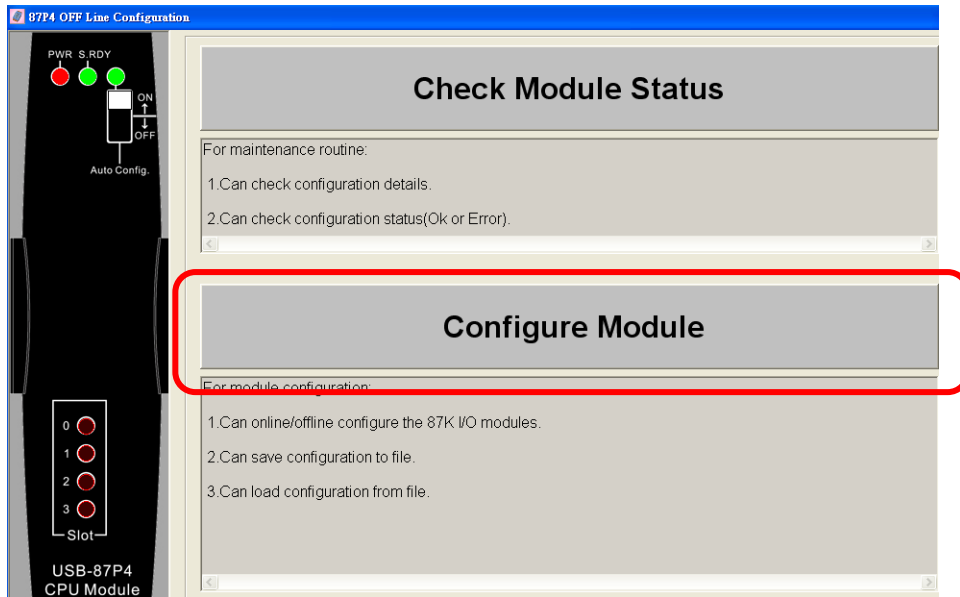

Fig. 22 : Off-line operation

Click “Configure Module” to enter setup screen.



**Step2 :** Select and configure the I/O modules, then click “Save configuration” to save the settings as the file, or else next time when you open the “configure module” screen in off-line mode, the previous settings will be deleted.

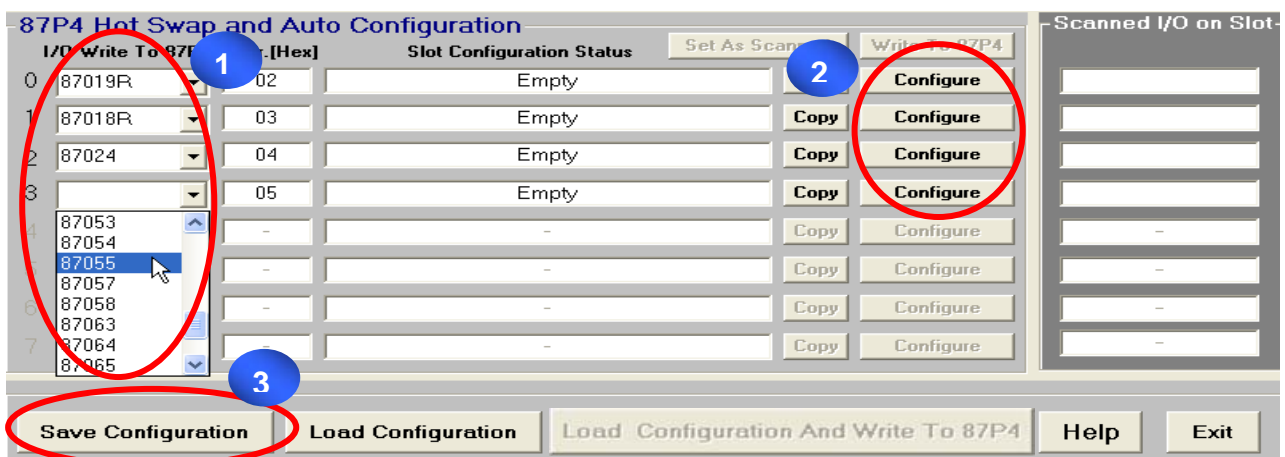
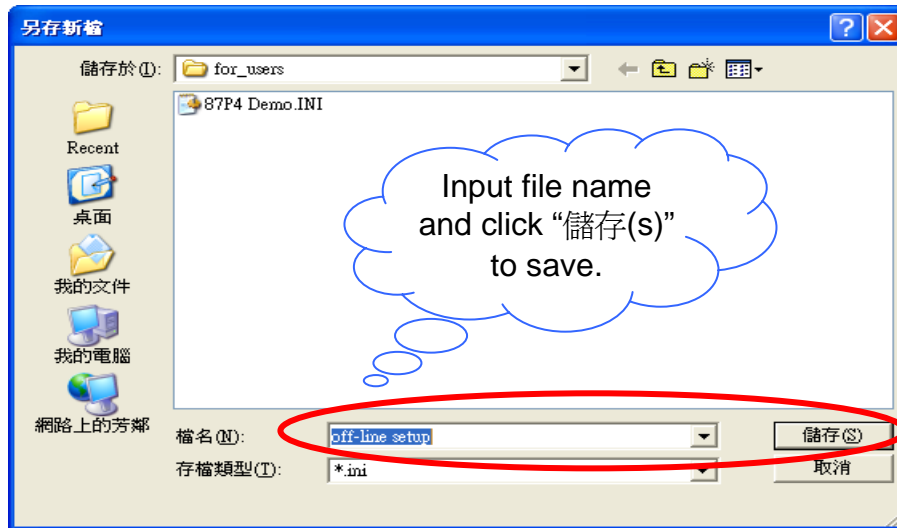

Fig. 23 : Off-line operation – Configure & Save file



**Step3 :** Run DCON Utility in another computer which has connected with 87Pn, load the settings by “Load configuration” button.

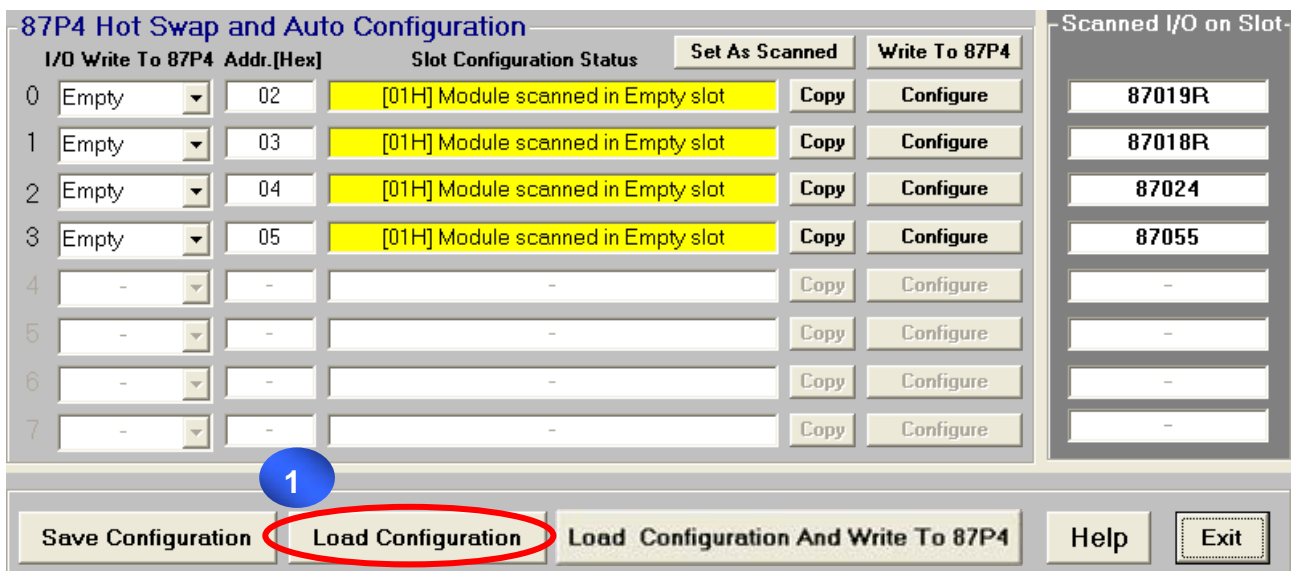
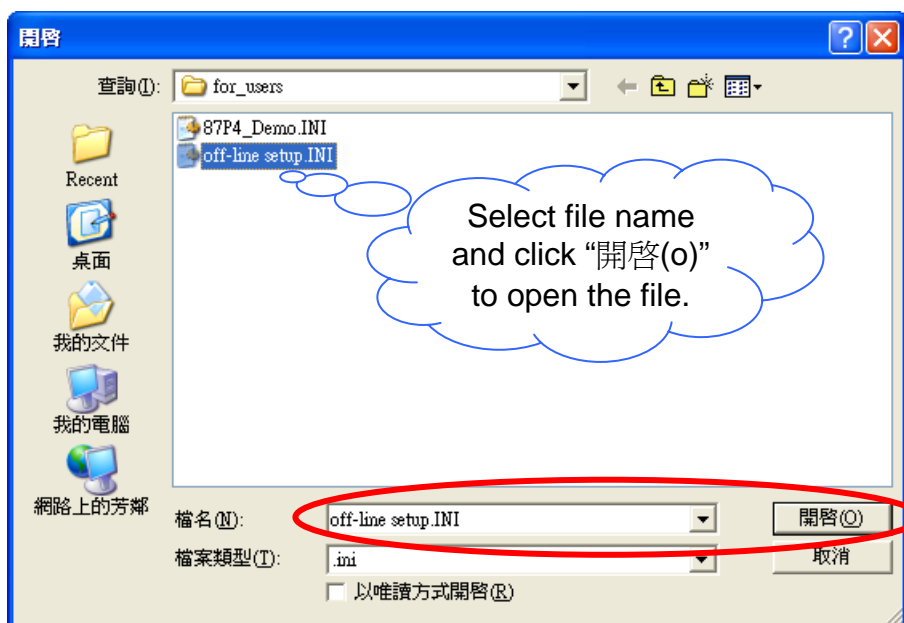

Fig. 24 : Load configure file in another PC



Click "Configure" button to check whether the settings is correct.

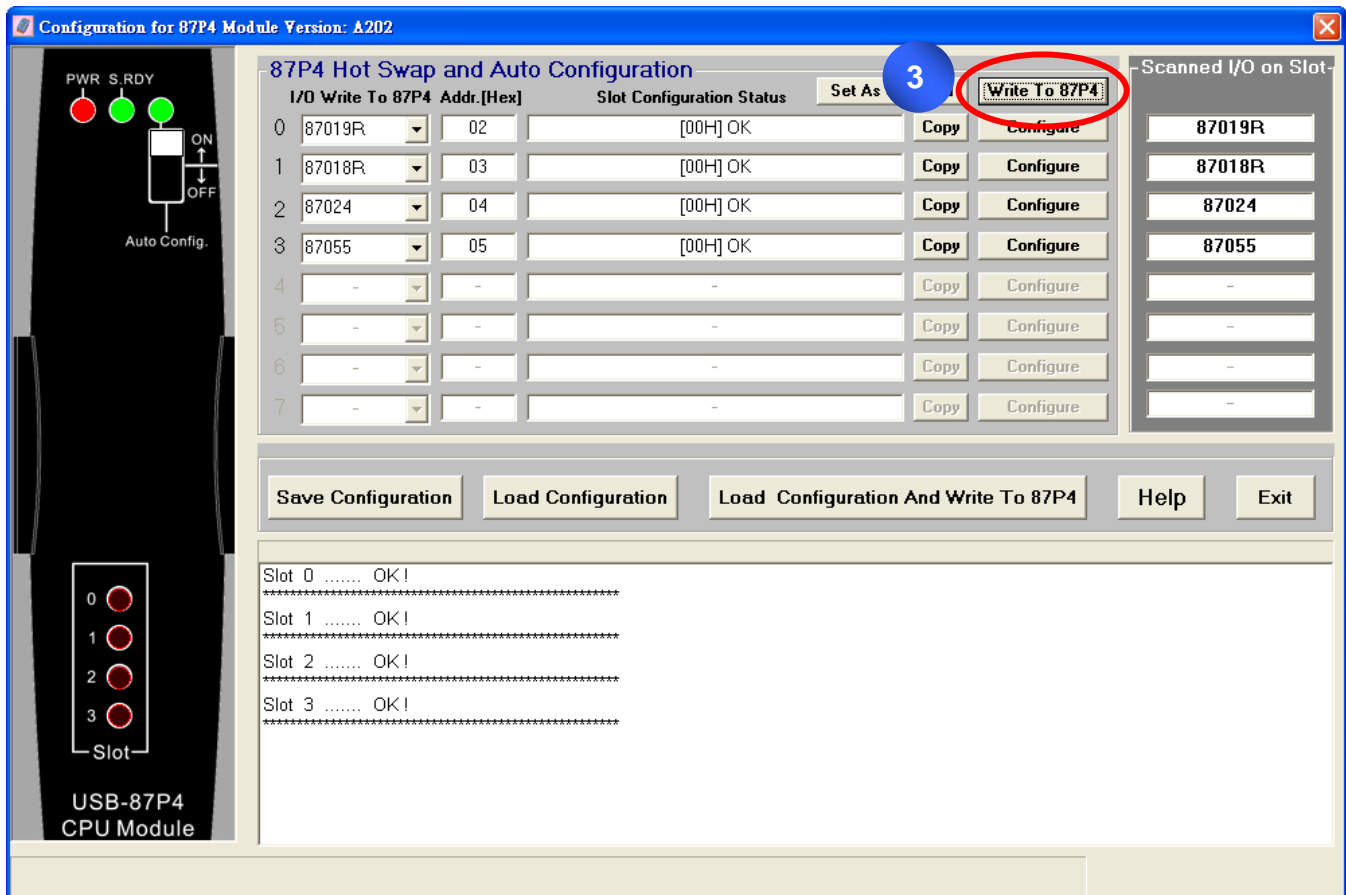
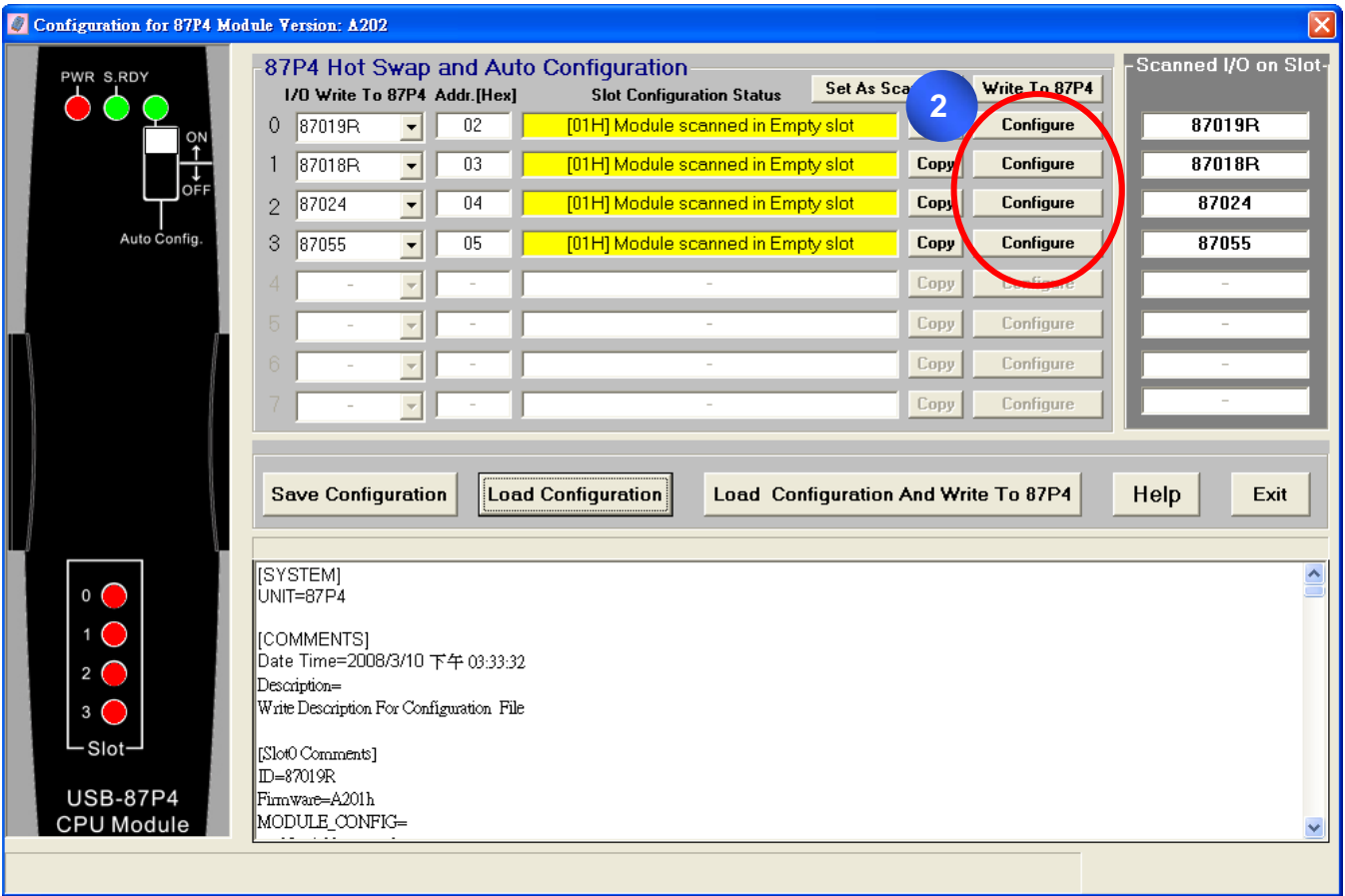
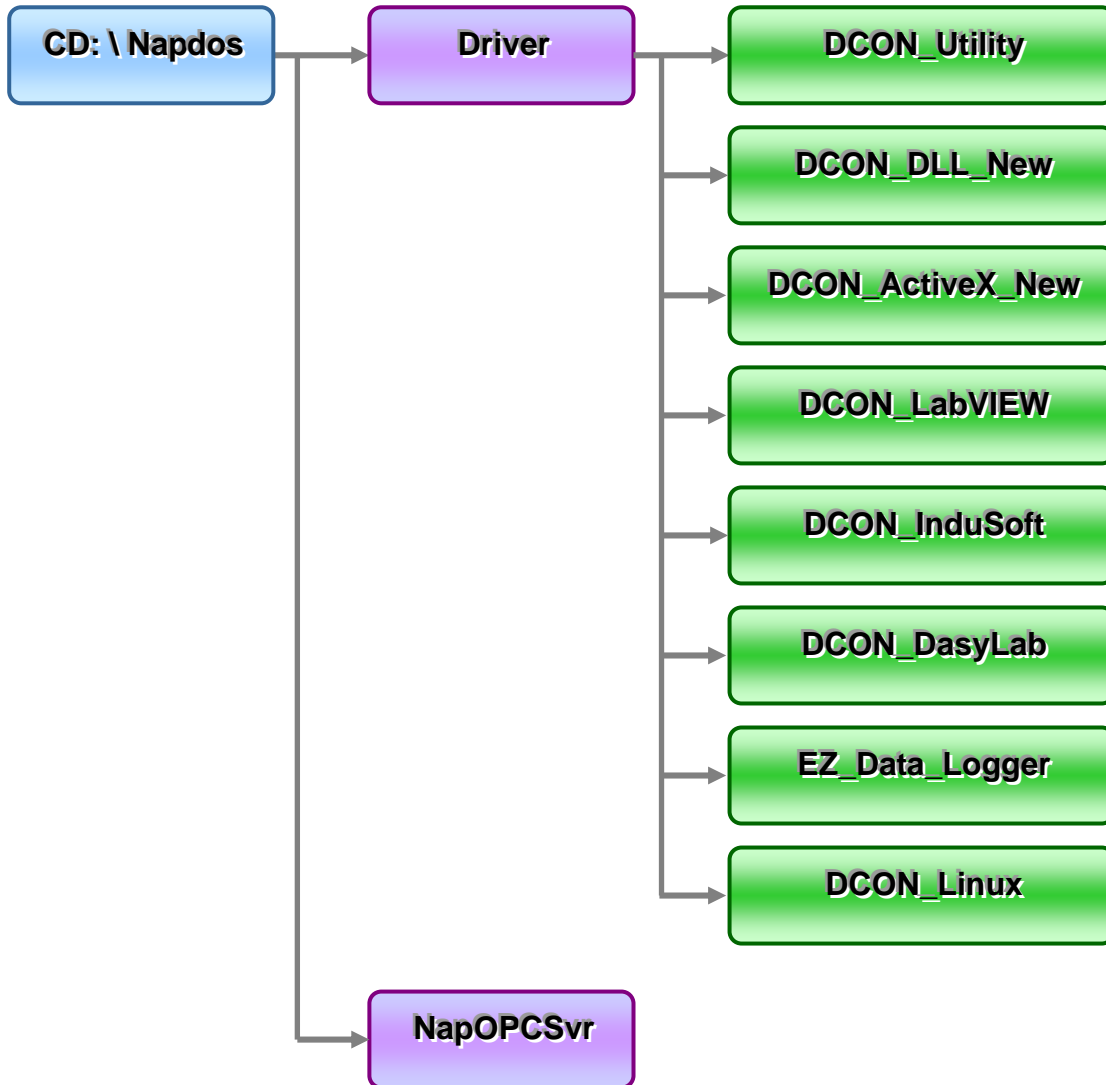

Fig. 25 : Write the settings to USB-87Pn

# Chapter 4 Software Development Kits (SDK)

The ICPDAS provides a series of free software development kits, enables the customer to be fast and simply completes the system setup. Related software tools are in the CD, please refer to following diagram:



## 4.1 DCON DLL

DCON DLL provide program developers to read the program interface which used on control I/O modules, the position of CD place provides a few basic and simple examples, user can understand how to read the control I/O module through the DLL in following examples:

### 4.1.1 DLL Use Steps

**Step 1: Read the basic and important documents**

**Readme.txt:** contains most basic and important information, including:

- What is DCON DLL
- What files are installed on the PC
- The directory tree installed on the PC
- Demo list

**Step 2: Install the DCON DLL by executing:**

- CD:\Napdos\Driver\DCON\_DLL\_New\Setup\setup.exe

After installation, all related information can be found below

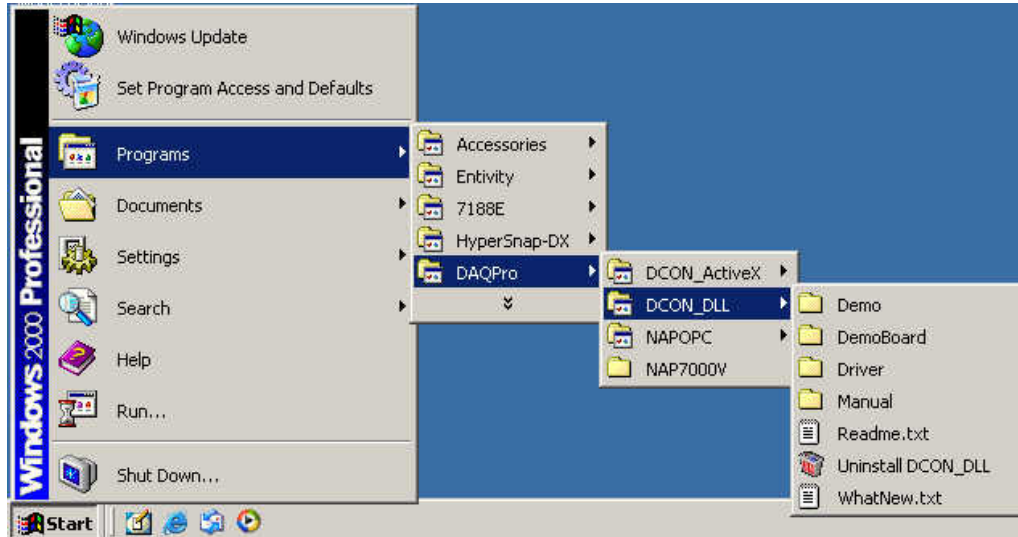

**Step 3 :** Read manuals for how to start

**QuickStartManual.pdf:**

Explains how to develop your first program using the DLL.

DCON\_DLL.pdf explains the following details

- How to include the DLL in VB/VC/Delphi/BCB
- How to develop a program in VB/VC/Delphi/BCB
- Demo list
- Function descriptions and usage

**FAQ.pdf:**

Gives solutions to frequently asked questions.

**Step 4 :** Run the demo programs to test the I/O module and learn the functions

## 4.1.2 VB Example (Reading an analog input value)

The following is an example of reading analog values from an i-87017 inserted in slot 0 of an 8410/8810.

**Step 1:** Run the DCON Utility to configure the I/O modules

**Step 2:** Run VB and create a new project (.exe project)

**Step 3:** Add I7000.bas to the project

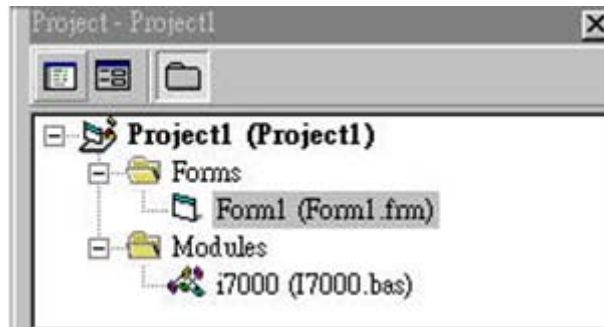

**Step4:** Arrange all the components on the form

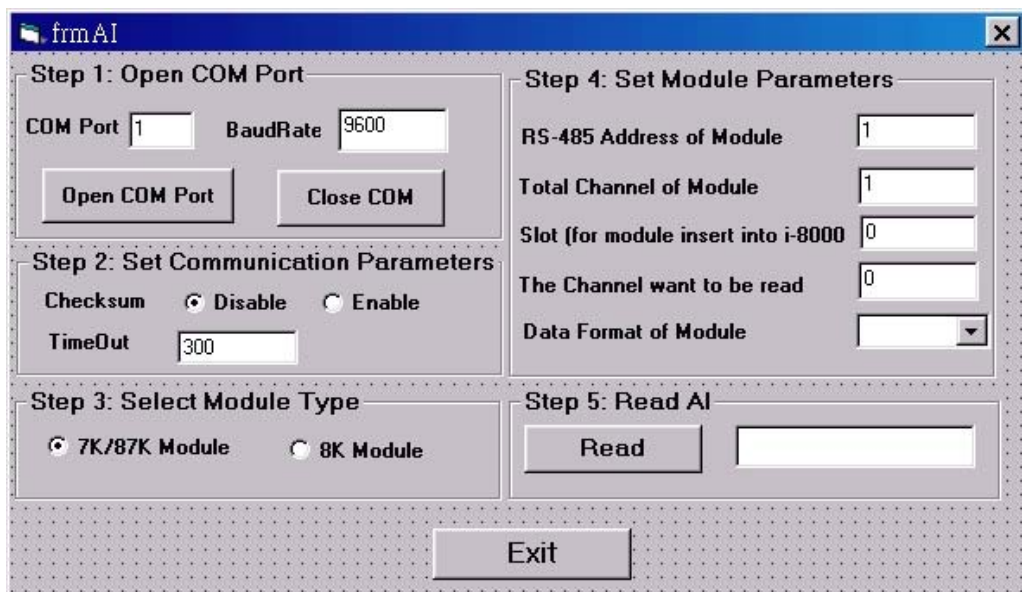

**Step5:** Write the program code



```

VB Step 1 {
Private Sub cmdOpen_Click()
    iPort = 5           'Use COM Port = 5
    iBaudrate = 115200 'Use Baud Rate = 115200
    Open_Com 5, 115200, 8, 0, 0 'To Open COM Port
End Sub

VB Step 2 {
Private Sub cmdRead_Click()
    Dim iRet As Integer
    Dim iVal As Integer
    Dim fVal As Single
    Dim iSlot As Integer
    Dim iTotal As Integer
    Dim iCh As Integer
    Dim iAddress As Integer
    Dim iFormat As Integer

    iAddress = 3           'Module Address = 3
    iChecksum = 0         'Checksum Disable
    iTimeout = 300        'Timeout For Response
    iSlot = -1            'Don't Need to Assign Slot For 87K I/O
    iCh = 0               'Read Channel 0 AI Value
    iTotal = 8            'Total Channel Of AI Module
    iFormat = 0
    iRet = DCON_Read_AI(iPort, iAddress, iSlot, iCh, iTotal, _
        iChecksum, iTimeout, iFormat, fVal, iVal)

    If iRet = 0 Then
        txtRead.Text = Str(fVal) 'The Queried AI Value
    Else
        txtRead.Text = "Error" + Str(iRet)
    End If
End Sub

VB Step 3 {
Private Sub cmdClose_Click()
    Close_Com (5)        'To Close COM Port
End Sub

```

**Step 6: Run the project.**

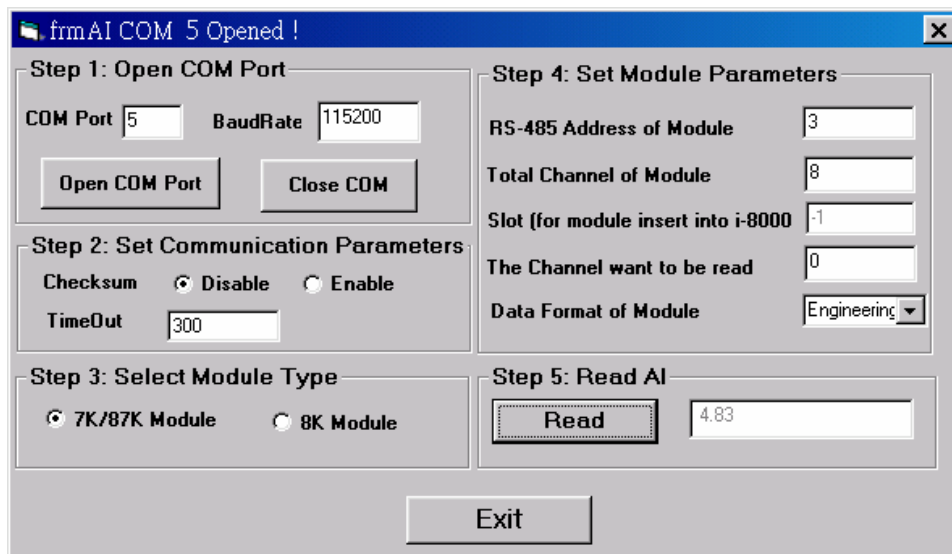

## 4.2 DCON ActiveX

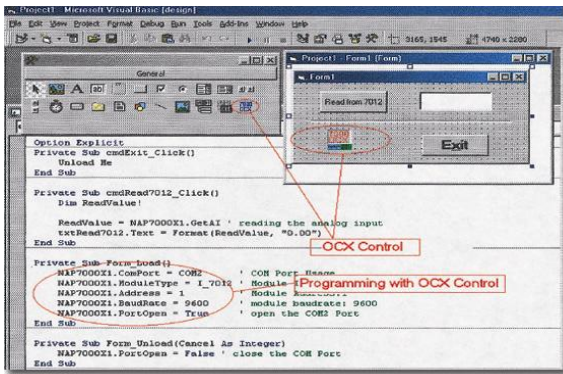

## [DCON ActiveX](#)

ActiveX (ocx) component

**Supported module:**

i-7000/8000/87K series  
(with DCON protocol)

**Supported demos:**

VB/VC/BCB/Delphi

**Supported OS:**

Windows 98/NT/2K/XP

**File Location:**

CD:\Napdos\Driver\DCON\_ActiveX

### 4.2.1 Procedure for using the ActiveX

**Step 1: Read the basic and important documents**

**Readme.txt:** contains most basic and important information, including:

- What is DCON ActiveX
- What files are installed on the PC
- The directory tree installed on the PC
- Demo list

**WhatsNew.txt:** contains most basic and important information, including:

- Bugs fixed
- Demos added or modified
- Updated ActiveX (ocx) details

**Step 2: Install the DCON DLL by executing:**

- CD:\Napdos\Driver\DCON\_ActiveX\_New\Setup\setup.exe

After installation, all related information can be found below

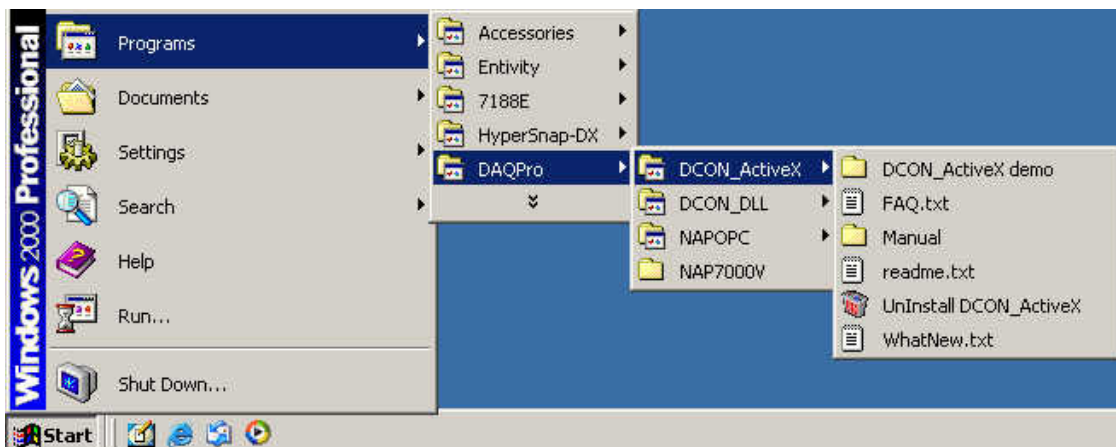

### Step 3: Read manuals for how to start.

#### InstallOCX.pdf:

Explains how to install/uninstall the ActiveX (ocx) component in VB/VC/Delphi/BCB

DCON\_ActiveX.pdf explains the following details:

- How to include the ActiveX(ocx) in VB/VC/Delphi/BCB
- How to develop a program in VB/VC/Delphi/BCB
- Demo list
- Function descriptions and usage

### Step 4: Run the demo programs to test the I/O module and learn the functions

## 4.2.2 VB Example (Reading an analog input value)

The following is an example of reading analog values from an i-87017 inserted in slot 0 of an 8410/8810.

#### Step 1: Run the DCON Utility to configure the I/O module

#### Step 2: Run VB and create a new project (.exe project)

#### Step 3: Add the ActiveX (ocx) component to the project

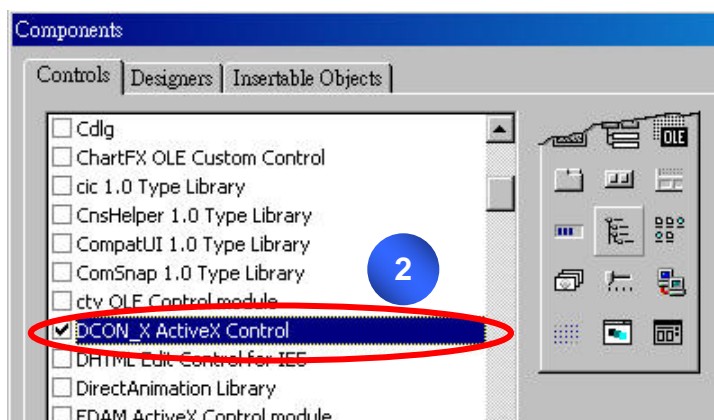
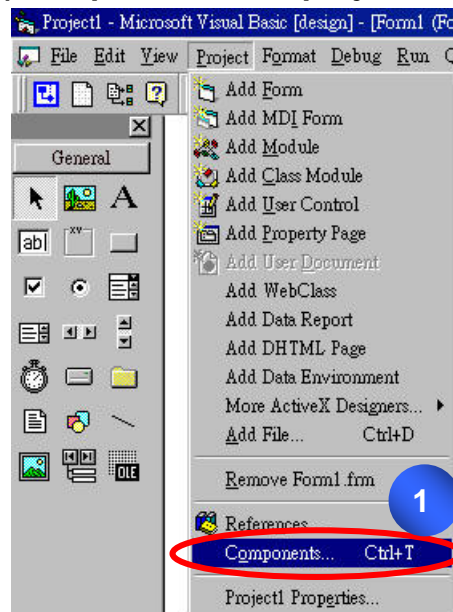

## Step 4 : Arrange all the components on the form

## Step 5: Write the program code

```

Private Sub CmdOpenCom_Click()
    DCONPC_X1.ComPort = 5           'Use COM Port = 5
    DCONPC_X1.Baudrate = 115200    'Use Baud Rate = 115200
    DCONPC_X1.PortOpen = True      'True To Open COM Port
End Sub

Private Sub Read_AI_Click()
    Dim AIVAl As Single
    Dim AIVAl_Hex As Integer, iDataformat As Integer

    DCONPC_X1.ComPort = 5           'Use COM Port = 5
    DCONPC_X1.Address = 1           'Module Address = 1
    DCONPC_X1.SlotNo = -1           'Don't Need to Assign Slot For 87K I/O
    DCONPC_X1.AI_TotalChannel = 8   'Total Channel Of AI Module
    DCONPC_X1.Checksum = False      'Checksum Disable
    DCONPC_X1.Timeout = 300         'Timeout For Response
    iDataformat = 0                 '0: Use Engineering Format
    AIVAl = DCONPC_X1.AnalogIn(0)   'Read Channel 0 AI Value
    TextReadAI.Text = AIVAl

    If DCONPC_X1.ErrorCode <> 0 Then
        Exit Sub
    End If
End Sub

Private Sub CmdCloseCom_Click()
    DCONPC_X1.PortOpen = False      'False To Close COM Port
End Sub

Private Sub DCONPC_X1_OnError(ByVal IErrorCode As Long)
    MsgBox "Error Code: " + Str(IErrorCode) + Chr(13) _
        + "Error Message: " + DCONPC_X1.ErrorString
End Sub

```

VB Step 2 {

VB Step 3 {

VB Step 1 {

## Step 6: Run the Project

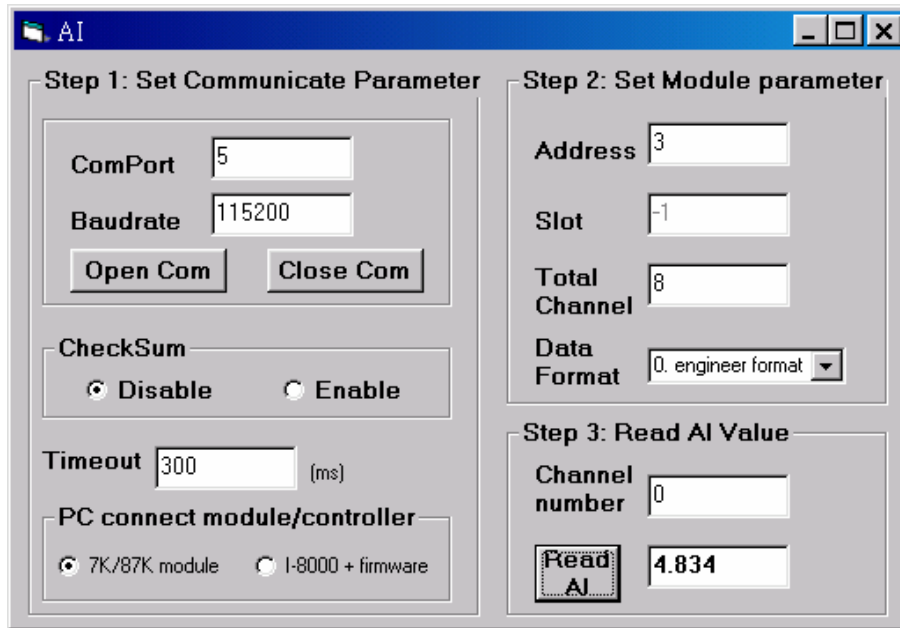

## 4.3 DCON LabVIEW

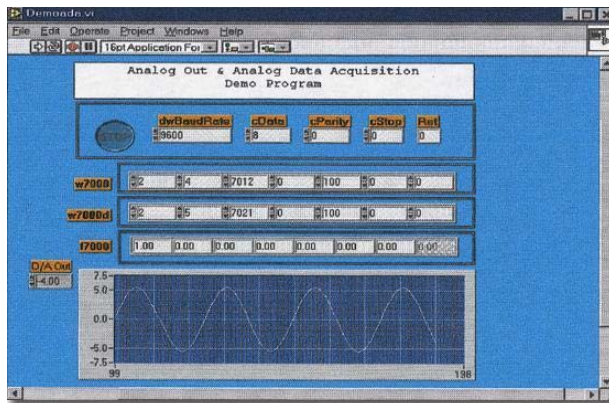

### [DCON LabVIEW](#)

Bundled driver for LabVIEW

**Supported module:**

i-7000/8000/87K Series  
(With DCON Protocol)

**Supported OS:**

Windows 98/NT/2K/XP

**File Location:**

CD: \Napdos\Driver\DCON\_Labview

### 4.3.1 Procedure for using DCON\_LabVIEW

**Step 1 :** Install the DCON LabVIEW by executing:

- CD:\Napdos\Driver\DCON\_Labview\DCON\_Labview.exe

After installation, the related information can be found as below:

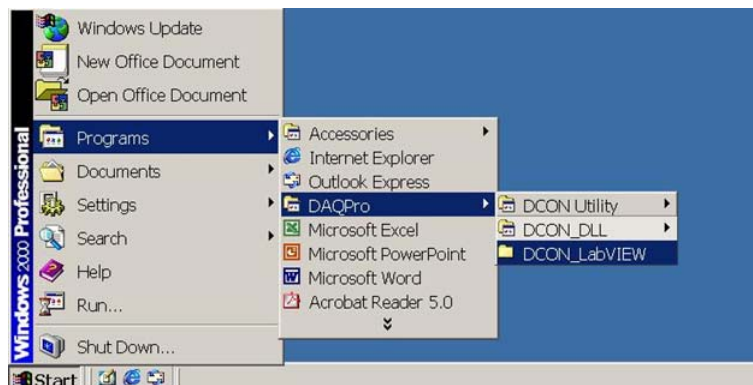

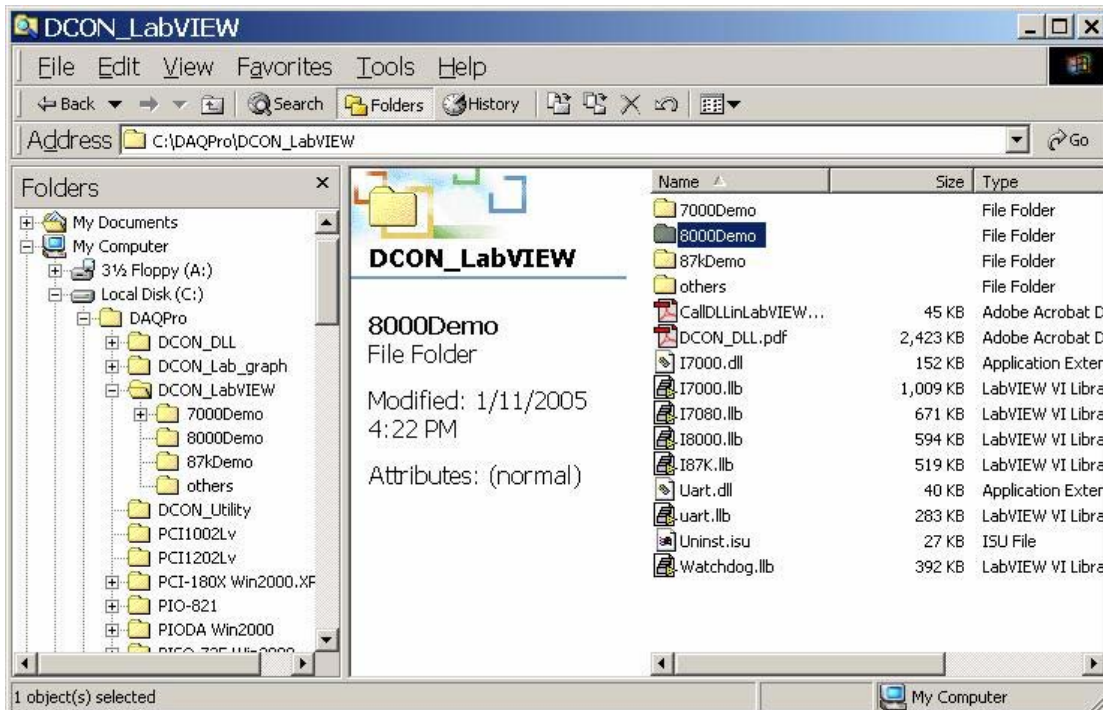

**8000 Demo:** Demo programs for i-8000 I/O modules.

**8000.lib:** LabVIEW library contains all sub-vi for i-8000 I/O modules

**CallDLLinLabVIEW.pdf:** Explains how to call a sub-vi of in LabVIEW.

**DCON\_DLL.pdf:** Descriptions of all sub-function in DCON\_DLL.

**Step 2: Create a new LabVIEW program.** Refer the DCON\_DLL.pdf about detail description of the sub-vi and where to select the sub-vi in various library of DCON\_LabVIEW.

**Step3: Select the sub-vi form Functions Palette >> Select a VI...**

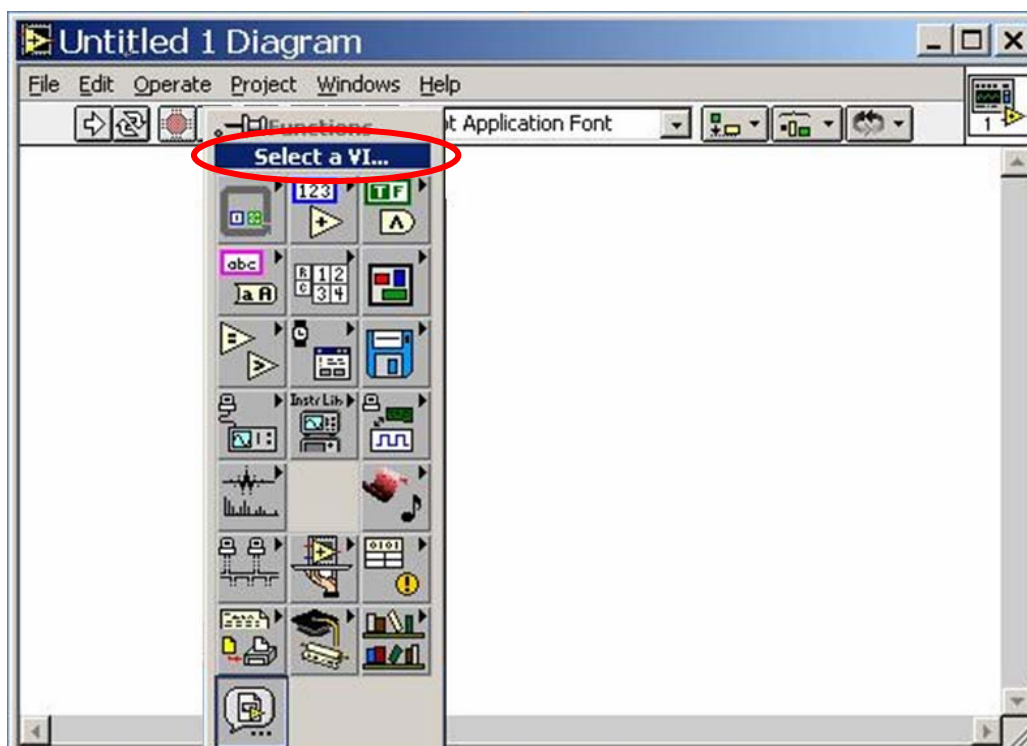

### 4.3.2 LabVIEW Example (Reading multi-channel analog Input value)

Step4 : Select the target \*.lib file (LabVIEW library file)

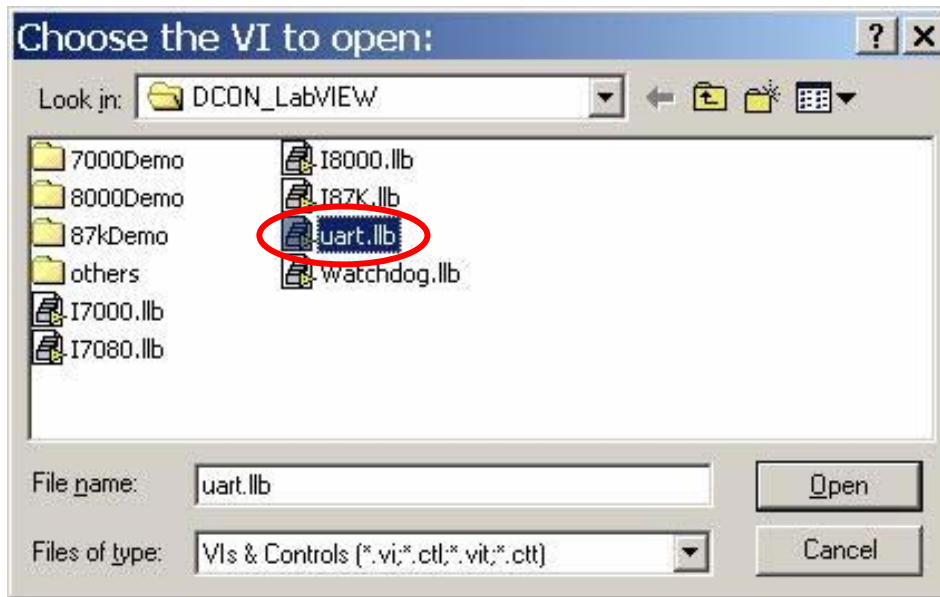

Step5 : Select the desired sub-vi



Step6 : Put the icon of selected sub-vi on Block Diagram, refer the "Help" >> "Show Help" or "[DCON\\_DLL.pdf](#)" in step1 for detail.

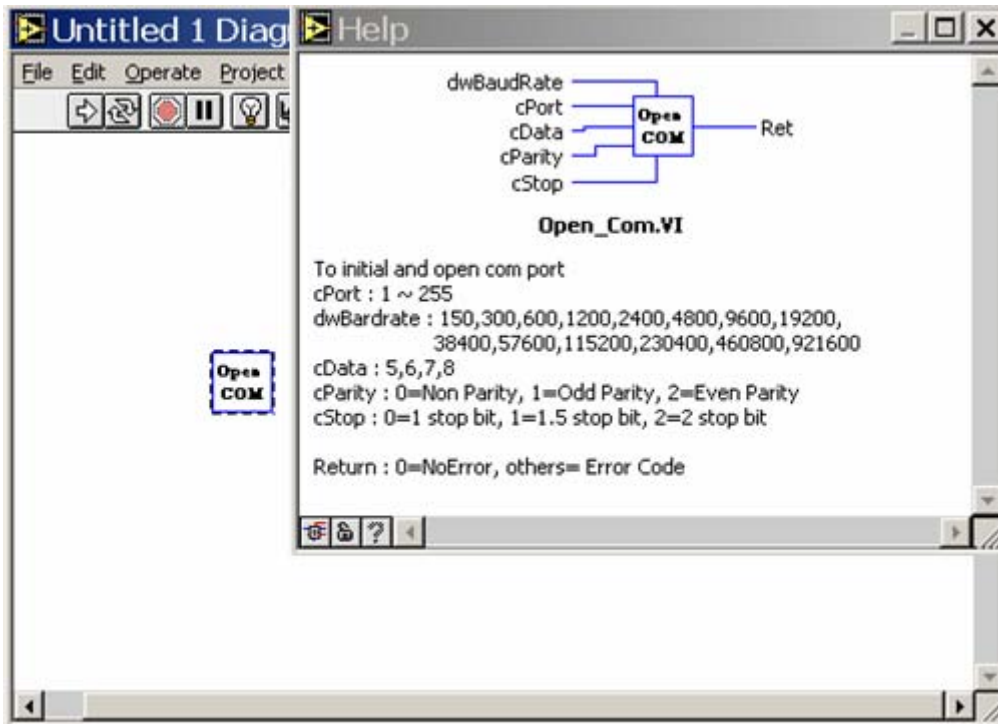

**Step7 :** Draw the data flow of sub-vi.

### 4.3.3 LabVIEW Demo Program (Reading multi-channel analog input value)

**Step 1:** Select the appropriate demo program (ex. AnalogInAll.vi) by the name according with module's function (ex. i-8017 / AI ).

**Step2:** Set the parameters

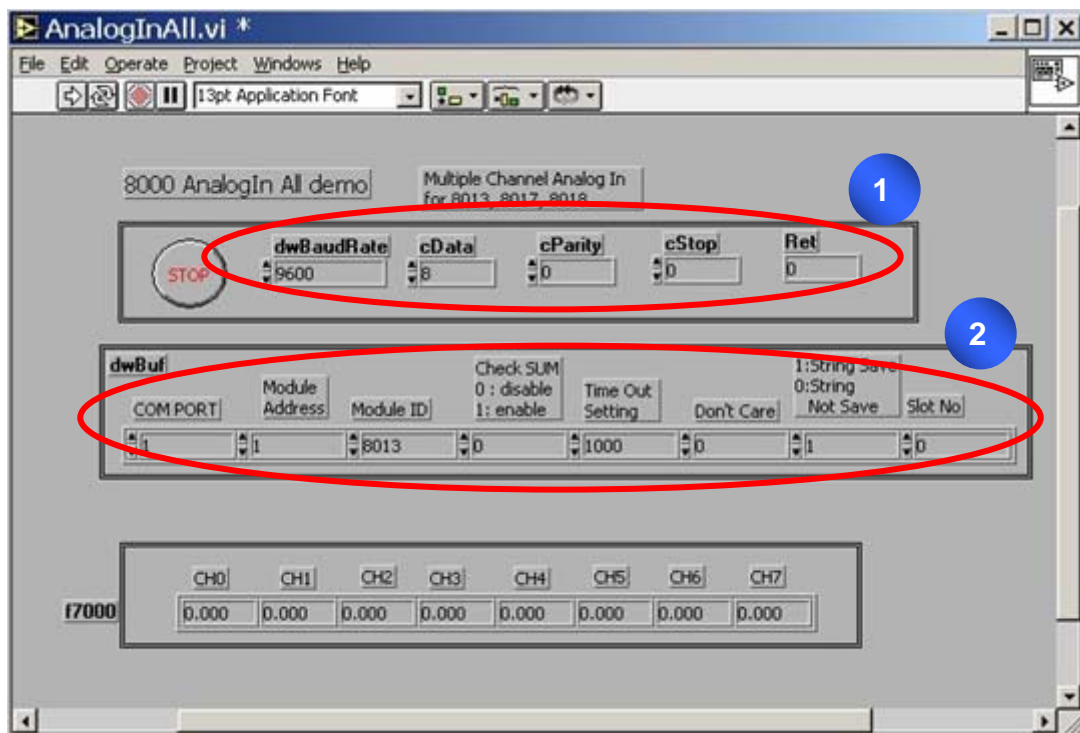



You could also refer the “Help”>>”Show Context Help” for getting the simple description of those parameters.

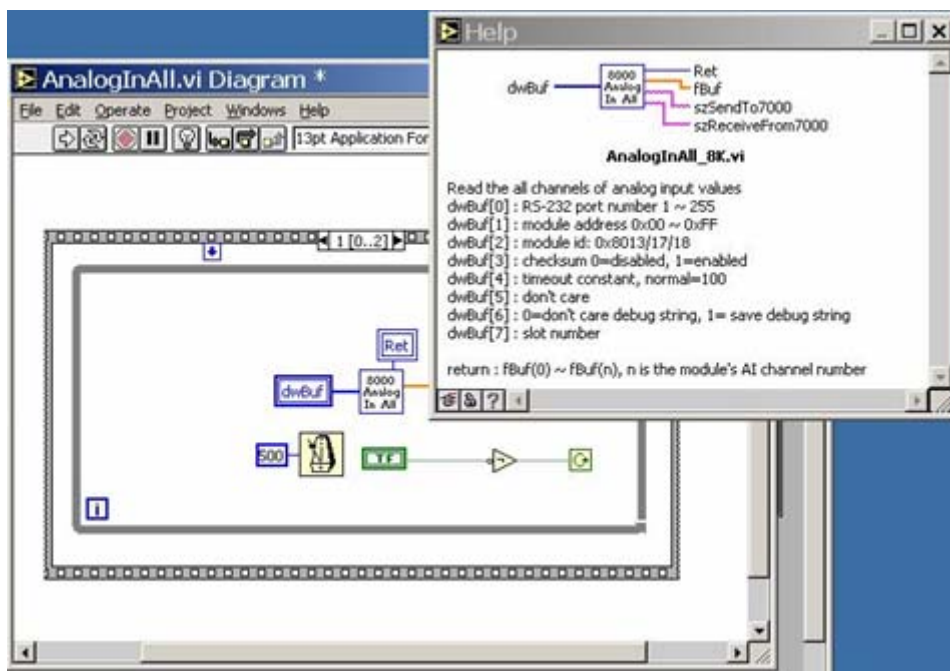

Step3 : Run the Demo.

## 4.4 DCON Indusoft

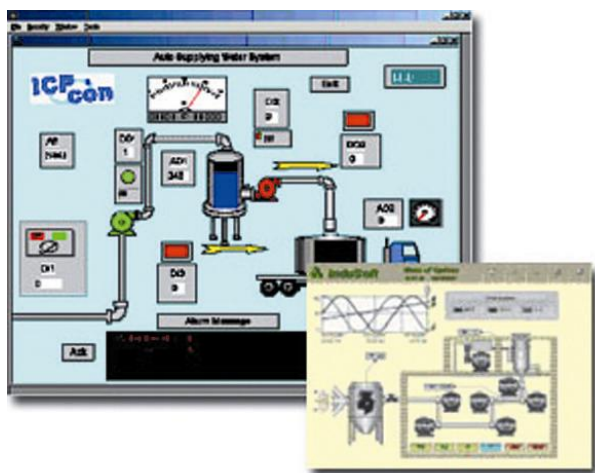

### [DCON Indusoft](#)

Bundled driver for Indusoft

**Supported module:**

i-7000/8000/87K Series  
(With DCON Protocol)

**Supported OS:**

Windows 98/NT/2K/XP/CE

**File Location:**

CD: \Napdos\Driver\DCON\_Indusoft

### 4.4.1 Procedure for using the Indusoft bundled driver

Step 1: Read the basic and important documents

**Readme.txt: contains the basic and important information, including:**

- Files on the shipped CD

**Reversion.txt:** contains the reversion information, including

- Bugs fixed
- New modules supported

**Step 2: Install the Indusoft bundled driver by executing**

- CD:\Napdos\Driver\DCON\_Indusoft\Setup\setup.exe

**Step 3: Read the manuals describing how to start**

- The DCON.pdf user's manual describes how to use the Indusoft bundled driver

**Step 4: Run the demo programs (ICPDriverTest.zip) to test I/O modules and learn the functions**

### 4.4.2 Indusoft Example (Reading an analog input value)

The following is an example of reading analog values from an i-87018 inserted in slot 0 of an 8410/8810.

**Step 1: Run the DCON Utility to configure the I/O modules**

**Step 2: Run Indusoft and create a new project**

**Step 3: Include the DCON driver**

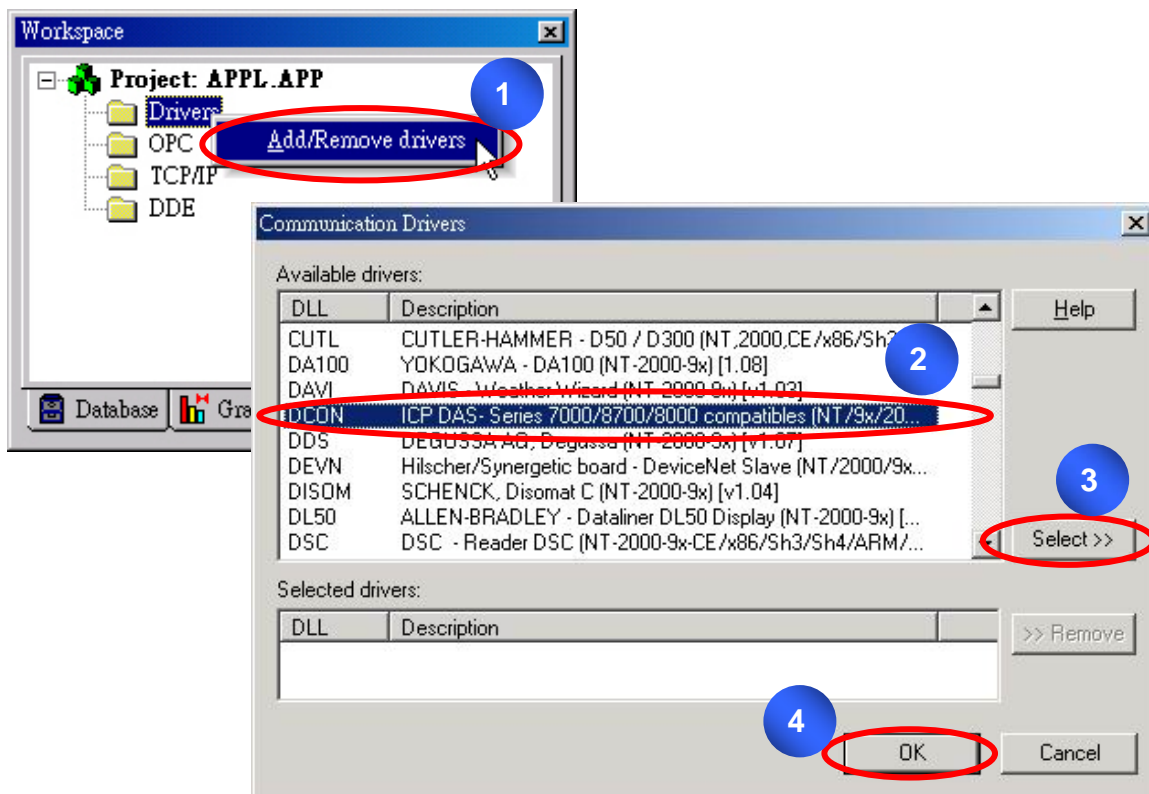

**Step 4: 設定 DCON 驅動程式**

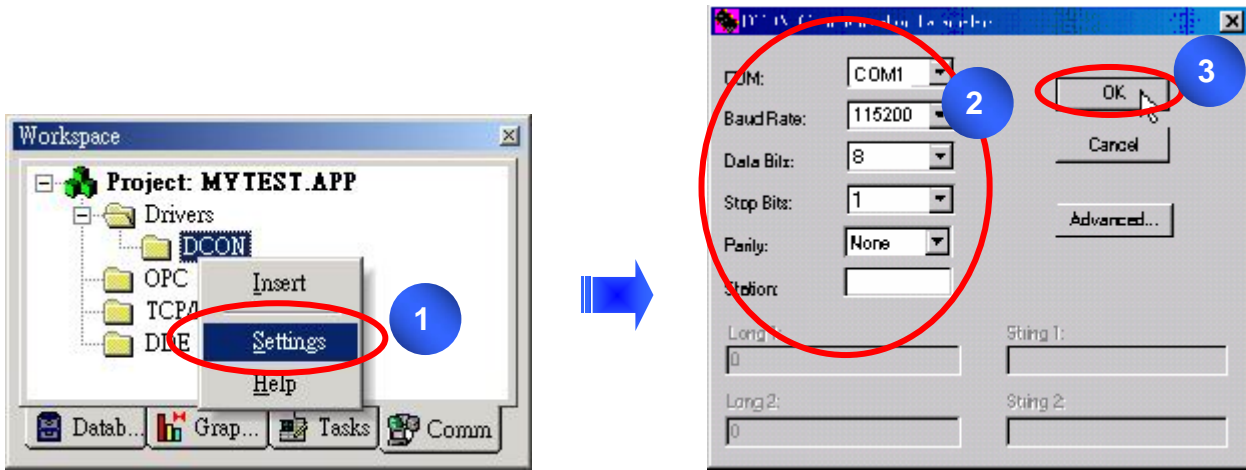

### Step 5 : Insert tags to connect to I/O modules

The address format is [Address : Module ID : Slot : Channel]

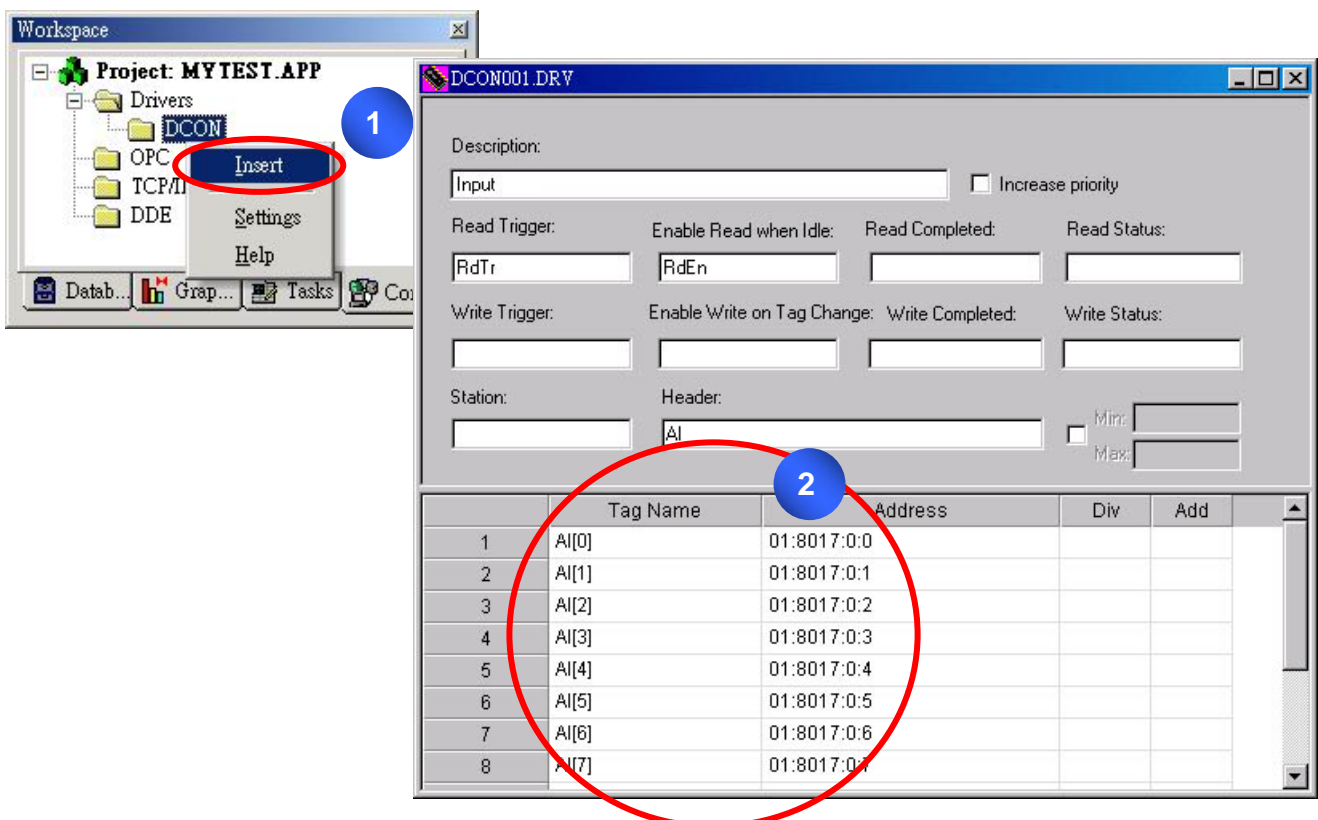

### Step6 : Arrange all the components on the form

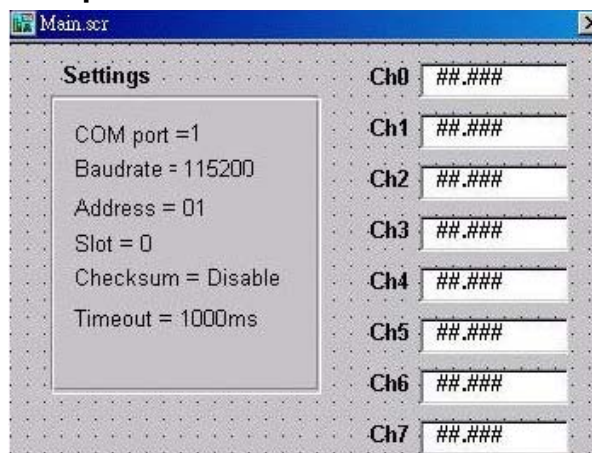

**Step7: Double click the text box to assign a tag to it.**

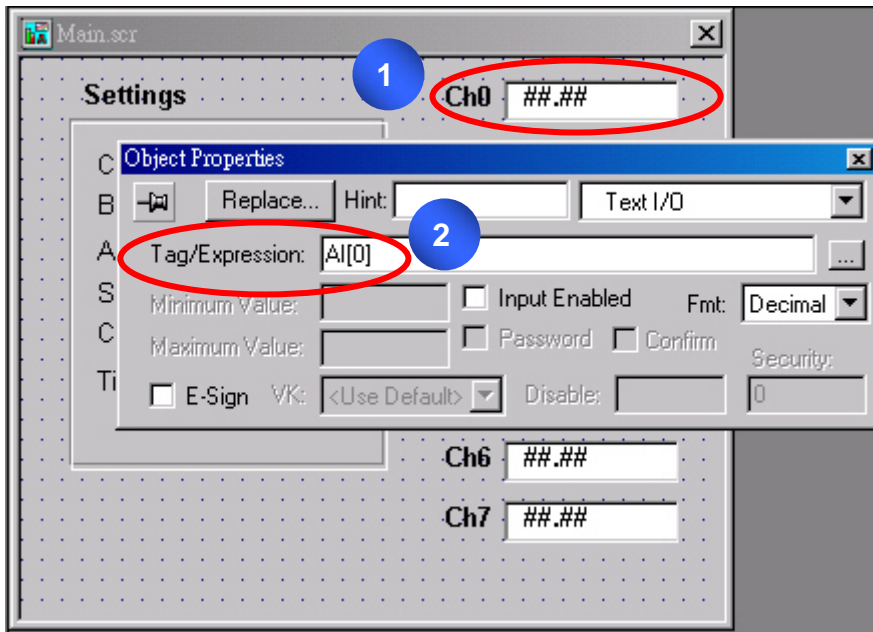

**Step8 : Run the project**



## 4.5 NAP OPC Server



### [NAP OPC server](#)

#### OPC Server

#### Supported Module:

i-7000/8000/87K Series  
(With DCON Protocol)

Modbus embedded controller  
ISaGRAF embedded controller

#### Supported OS:

Windows 98/NT/2K/XP/CE

#### File Location:

CD:\Napdos\NapOPCSvr

OPC (OLE for Process Control) is the first standard resulting from the collaboration of a number of leading worldwide automation suppliers working in cooperation with Microsoft. Originally based on Microsoft's OLE COM (component object model) and DCOM (distributed component object model) technologies, the specification defined a standard set of objects, interfaces and methods for use in process control and manufacturing automation applications to facilitate interoperability. The COM/DCOM technologies provided the framework for software products to be developed. There are now hundreds of OPC Data.

### 4.5.1 Procedure for using the OPC server

#### Step 1: Read the basic and important documents

**Readme.txt:** contains the basic and important information, including

- Files on the shipped CD

**Reversion.txt:** contains the reversion information, including

- Bugs fixed
- New modules supported

#### Step 2: Install the OPC server by executing

- CD:\Napdos\NapOPCSvr\NapOPCServer.exe

**Note:** If there is an older version of Nap OPC Server installed on the PC, It must be uninstalled before installing the new version.

#### Step 3: Read the manuals describing how to start

- The [NapOPCSvr.pdf](#) is the user's manual describing how to use the OPC server

## 4.5.2 OPC Server Example (Reading an analog input value)

The following is an example of reading analog values from an i-87018 inserted in slot 0 of an 8410/8810.

**Step 1: Run the DCON Utility to configure the I/O modules**

**Step 2: Run the OPC server to search for I/O modules on COM1**

The screenshot shows the DCON Utility software interface. The 'Search Modules' dialog box is open, and the 'Search' button is highlighted with a red circle and a blue '3'. The 'COM' dropdown is set to '1' and is also highlighted with a red circle and a blue '2'. The 'Search' button in the main toolbar is highlighted with a red circle and a blue '1'. The main window shows a tree view of modules and a table of channels.

Name	Type	Channel/Location
Ch00	Analog Output	0
Ch01	Analog Output	1
Ch02	Analog Output	2
Ch03	Analog Output	3

**Step 3: Save the configuration and close the OPC Server**

**Step 4: Run SCADA software to connect to the OPC Server**

The OPC Server user's manual lists the procedures for the following SCADA software:

■ Labview	■ National	■ WIZCON
■ iFix	■ Indusoft	■ Citect

Please refer to "Chapter 4 Connecting to the OPC Server" for more details.

# Appendix A : Dimension

## A.1 – USB-87P1

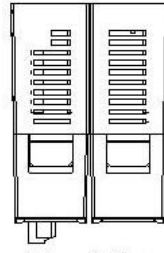

Top View

Unit: mm

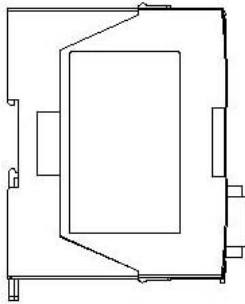

Left Side View

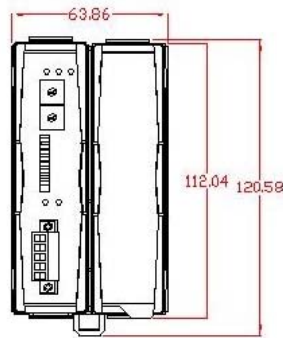

Front View

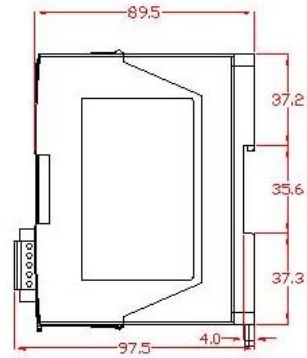

Right Side View

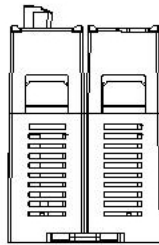

Bottom View

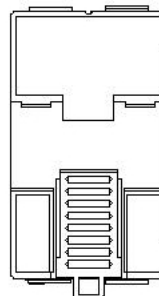

Back View

# A.2 – USB-87P2

Unit: mm

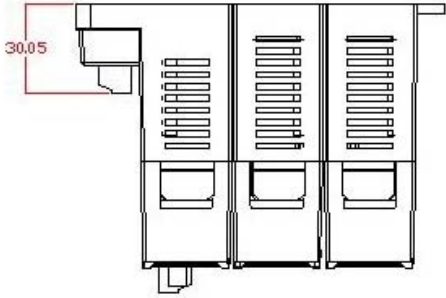

Top View

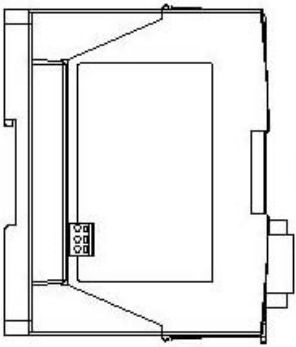

Left Side View

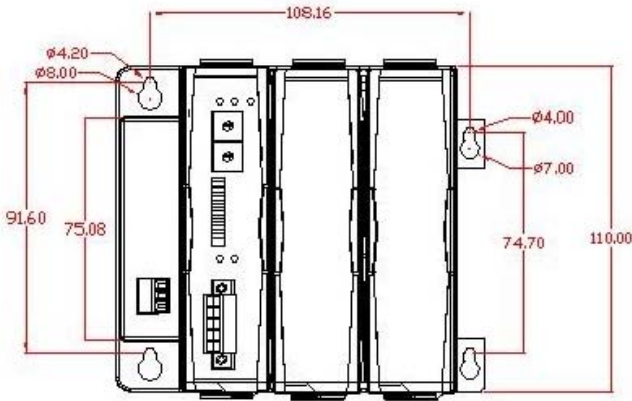

Front View

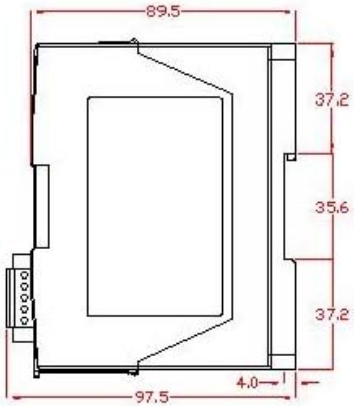

Right Side View

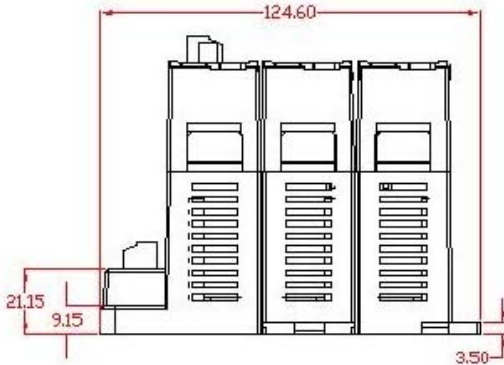

Bottom View

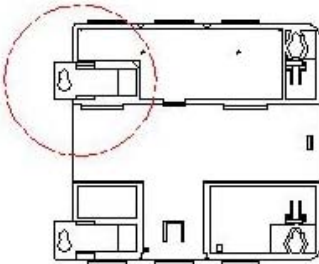
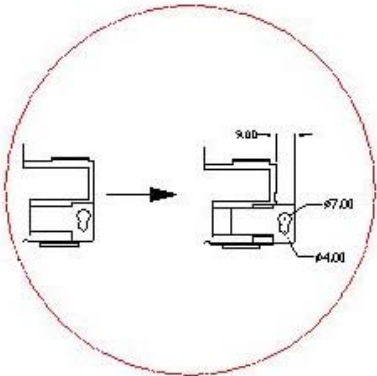

Back View



# A.3 – USB-87P4

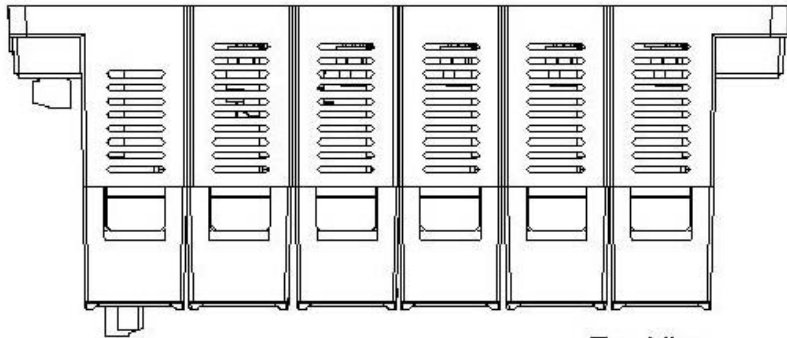

Top View

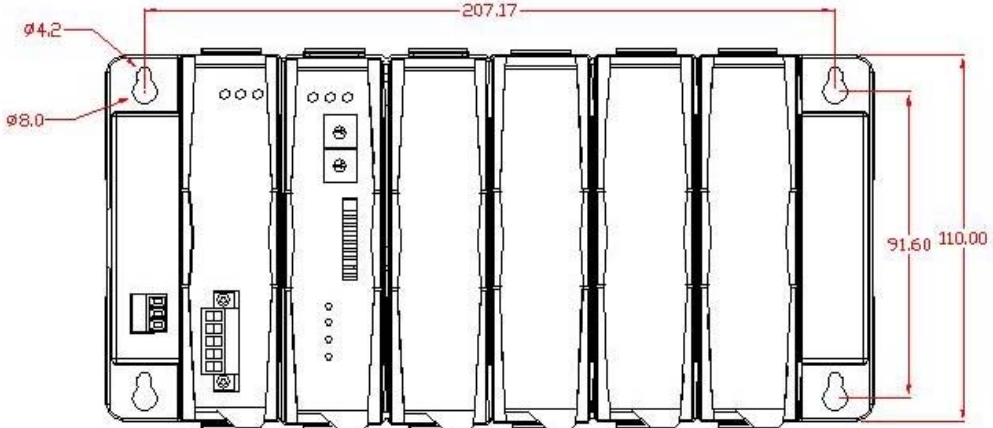

Front View

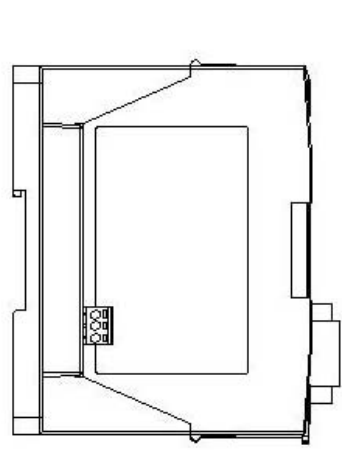

Left Side View

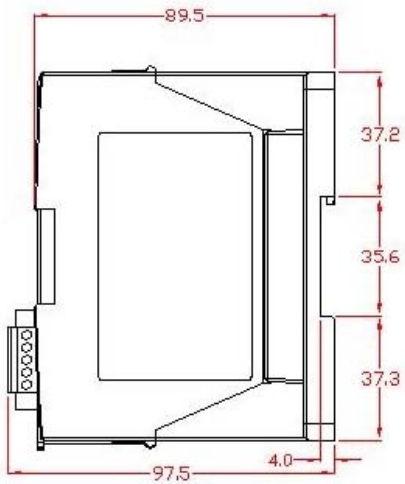

Right Side View

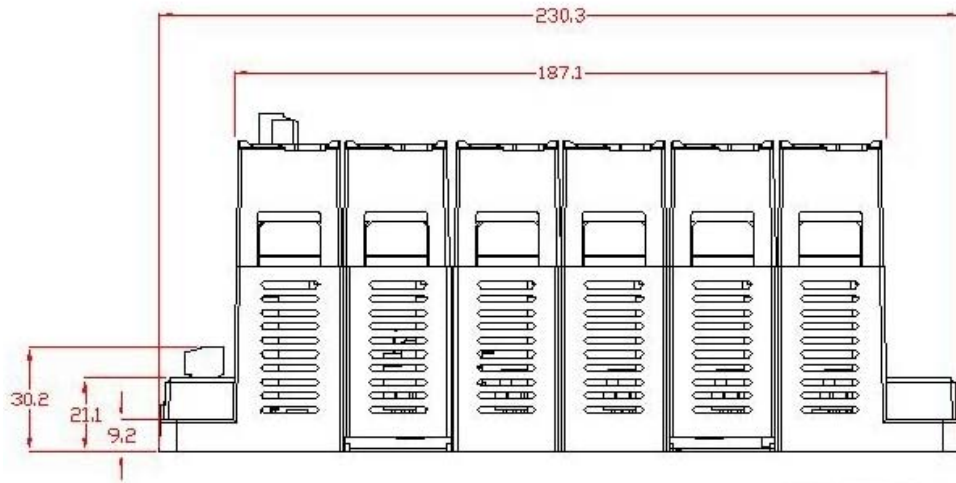

Bottom View

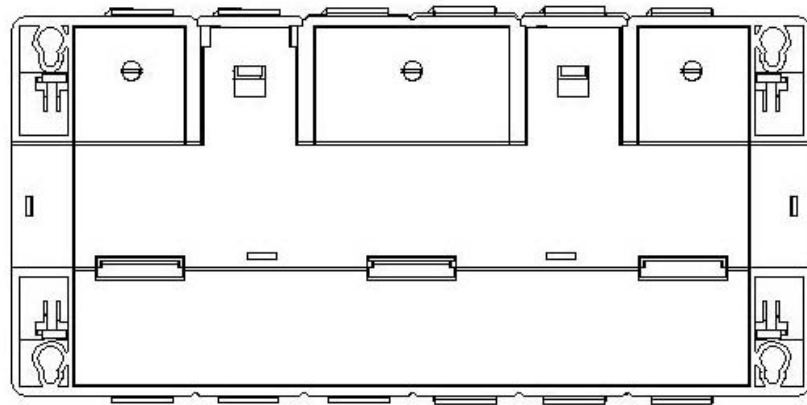

Unit: mm

Back View

# A.4 – USB-87P8

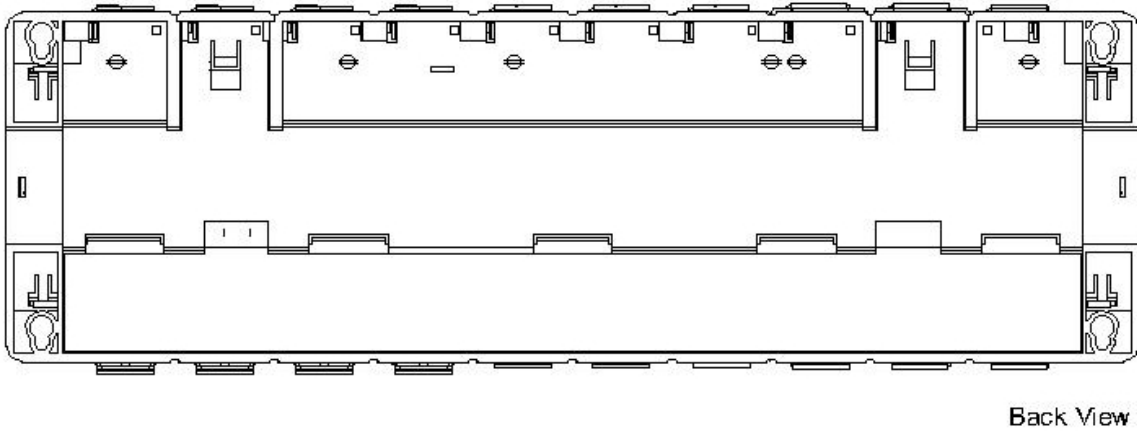
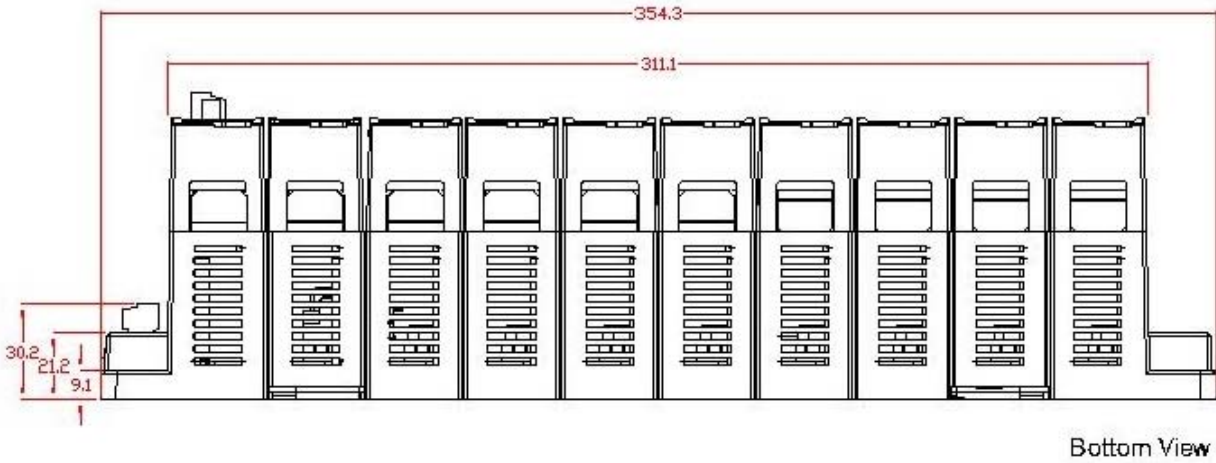
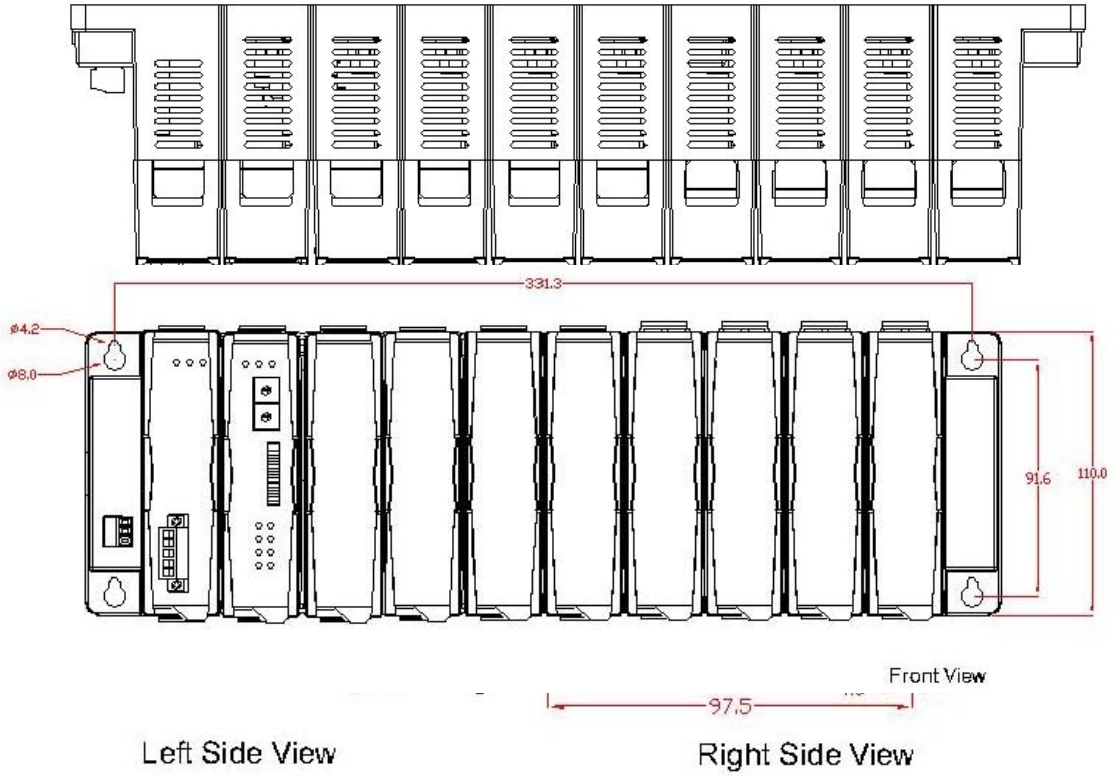

Unit: mm

## Appendix B : Compare USB-87Pn with i-87Kn

**Note:** i-87K I/O module has divides into the high profile (new version) and the low profile (old version) two kinds, **only i-87K high profile series I/O modules can support Hot Swap and Auto-Configuration function correctly.**

### USB-87Pn & i-87Kn I/O unit comparison

Supported	USB-87Pn with Auto Config. Enable	USB-87Pn with Auto Config. Disable	i-87Kn
i-87K Low Profile module	--	--	☺
i-87K High Profile module	☺	☺	☺
i-87K module Hot Swap	☺	☺	--
Auto- Communication parameter Setup	☺	☺	--
Auto-Configuration	☺	--	--

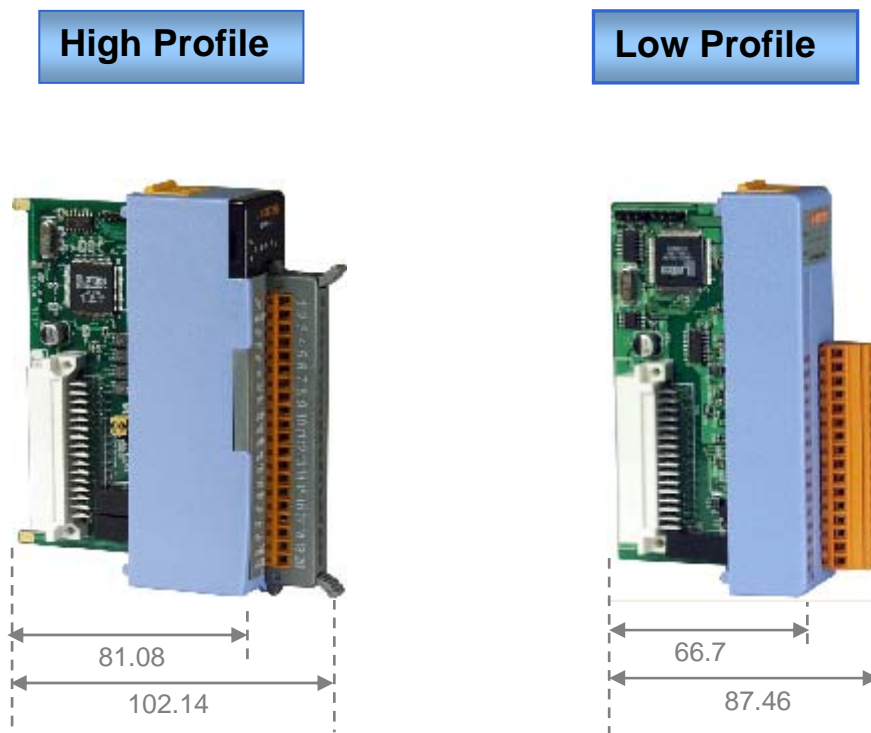

Fig. 26 : i-87K high/low profile series I/O modules

Please refer to web page :

[http://www.icpdas.com/products/PAC/i-8000/8000 IO\\_modules.htm](http://www.icpdas.com/products/PAC/i-8000/8000 IO_modules.htm)

## Appendix C : Solution for 87K I/O module on the slot

When insert the module on the expansion slot of 87Pn, the same time 87Pn CPU will detect the module name and respond the status of interacting between 87Pn and module. As following diagram, the search result only find out the USB-87P4 and a 87019R which on slot 0, the Status column shows Auto Config. Enable [0,X,X,X]

Module	Address	Baudrate	Checksum	Format	Status	Description
USB-87P4	1[1]	115200	Disable	N,8,1	Auto Config. Enable [0,X,X,X]	Slot Auto Configuration USB Unit(DCON)
-87019R	2[2]	115200	Disable	N,8,1	87P4 Slot[ 0 ]	8*AI (Universal mA,mV,V,Thermocouple)(DCON)

Fig. 27 : The search result between 87Pn and modules

Click the name “USB-87P4” entering the operation screen to know the settings of 87Pn and the status detected by 87Pn CPU, the module status code in "Slot Configuration Slot" column means the different error message.

I/O Write To 87P4	Addr.[Hex]	Slot Configuration Status	Set As Scanned	Write To 87P4
0 87019R	02	[00H] OK	Copy	Configure
1 87024	03	[06H] Can not find module	Copy	Configure
2 87055	04	[07H] Incorrect module name	Copy	Configure
3 Empty	05	[01H] Module scanned in Empty slot	Copy	Configure
4 -	-	-	Copy	Configure
5 -	-	-	Copy	Configure
6 -	-	-	Copy	Configure
7 -	-	-	Copy	Configure

Scanned I/O on Slot-

- 87019R
- Empty
- 87024
- 87055
- 
- 
- 
- 

Buttons: Save Configuration, Load Configuration, Load Configuration And Write To 87P4, **Help**, Exit

Callout: You may click "Help" to inquire the solution and the meaning of error code.

Fig. 28 : DCON Utility shows the status of 87Pn expansion slot

As following table, you can accord the error code and LED lamp status to find out the problem solution.

**Table 1 : The Error Code in Auto Config. Enable mode**

Error Code	Slot LED (Red)	Status	Description	Solution
00H	Dark (ok)	OK	OK	None
01H	Flashing (Warning)	Module scanned in Empty Slot	1. There is a module scanned in this empty setting slot.	1. Remove the module
			2. The first time to setup, no initial value.	Reconfigure it with DCON Utility. 1. Click "Set As Scanned" button and configure module again 2. Click "Write To 87Pn" button to write settings to 87Pn.
02H	Flashing (Warning)	Commands not comparable	<b>Configure failure:</b>	1. Check the i-87K I/O module's firmware.
			This is a 87K I/O module firmware compatibility problem . Some commands at this slot might be too new for this old firmware of 87K I/O module, but it is not serious for system operation.	* Run Dcon Utility→Terminal→Dcon command Line→ setup Baud Rate→Command: \$AAF (EX. 01F) →Send * You can see the version, Respond=!01A1.9 2. Update the 87K I/O module with a new firmware version.
03H	Bright (Error)	Configuration Failed	<b>Configure failure:</b>	1. Check the 87K I/O module firmware
			Some commands are not supported by this 87K I/O module and this error will be serious for system operation.	2. Update the 87K I/O module with a new firmware version.
04H	Bright (Error)	wrong Configuration format	<b>Configure failure:</b>	1. Run DCON Utility.
			The format of configured commands is wrong for DCON Protocol.	2. Click the "Write To 87Pn" button to write the settings to 87Pn CPU again.
05H	Bright	Read	<b>The memory data is failed:</b>	1. Run DCON Utility.

	(Error)	<b>Configuration failed</b>	The configured commands are wrong for DCON Protocol.	2. Click the "Write To 87Pn" button to write the settings to 87Pn CPU again.
06H	Bright (Error)	<b>Can not find module</b>	The configured module at this slot has been removed. It is empty now.	1. Please insert a correct module as previous configured one. 2. Or configure with DCON Utility as "Empty" and click the "Write To 87Pn" button to write the configuration to 87Pn CPU.
07H	Bright (Error)	<b>Incorrect module name</b>	<b>Configure failure:</b>	The insert & configure module name are different, insert the correct one or run the Dcon Utility to modify the settings accord with the module name.
			The module inserted in this slot is not the same as previous configured.	
08H	Bright (Error)	<b>Internal INIT* pin failed</b>	<b>Configure failure:</b>	1. Please restart the power to initialize to I/O module 2. If it still failed to initialize, send it back to factory to check.  Note: USB-87Pn only supports high profile 87K I/O modules.
			The INIT Pin is failed to connect with the GND and module failed to initialize.	
09H	Bright (Error)	<b>Module address over 255 (FFh)</b>	The module address is over 255 (FFh).	The maximum address of 87P1 is 254 (FEh) 87P2 is 253 (FDh) 87P4 is 251 (FBh) 87P8 is 247 (F7h)
0AH	Bright (Error)	<b>The command count saved to 87Pn is not the same as DCON Utility</b>	This error might be caused by following reasons. 1. Command length error. 2. Command checksum error. 3. Communication error during the process of writing commands to 87Pn.	Please configure this 87K I/O module with DCON Utility, and click the "Write To 87Pn" button to write the configuration to 87Pn CPU again.

**Table 2 : The Error Code in Auto Config. Disable mode**

Error Code	Slot LED (Red)	Status	Description	Solution
80H	Dark (ok)	Initialize ok	setup success	None
81H	Bright (Error)	Internal INIT* pin failed	The INIT Pin is failed to connect with the GND and module failed to initialize.	If it still fails after restart the 87Pn many times, please send the 87K I/O module back to factory to check.
82H	Bright (Error)	Module address over 255 (FFh)	The module address is over 255 (FFh).	The maximum address of 87P1 is 254 (FEh) 87P2 is 253 (FDh) 87P4 is 251 (FBh) 87P8 is 247 (F7h)

You can see the LED signals on 87Pn CPU module to know whether the 87Pn is operating properly. Please refer to appendix.

	Auto Config. LED (Green)	S.RDY LED (Green)	Slot Status LED (Red)
<b>Auto Config. Enable</b>			
No Error	Always ON	Always ON	Always OFF
Warning		Always ON	Flash
Failed		Flash	Always ON
<b>Auto Config. Disable</b>			
No Error	Always OFF	Always ON	Always OFF
Failed		Flash	Always ON



## Appendix D : Description For ini Files

While you save the configuration file, the DCON Utility will save as .ini file. The default path of file as below :

C:\ICPDAS\DCON\_Utility\for\_users

The INI file explains as follows:

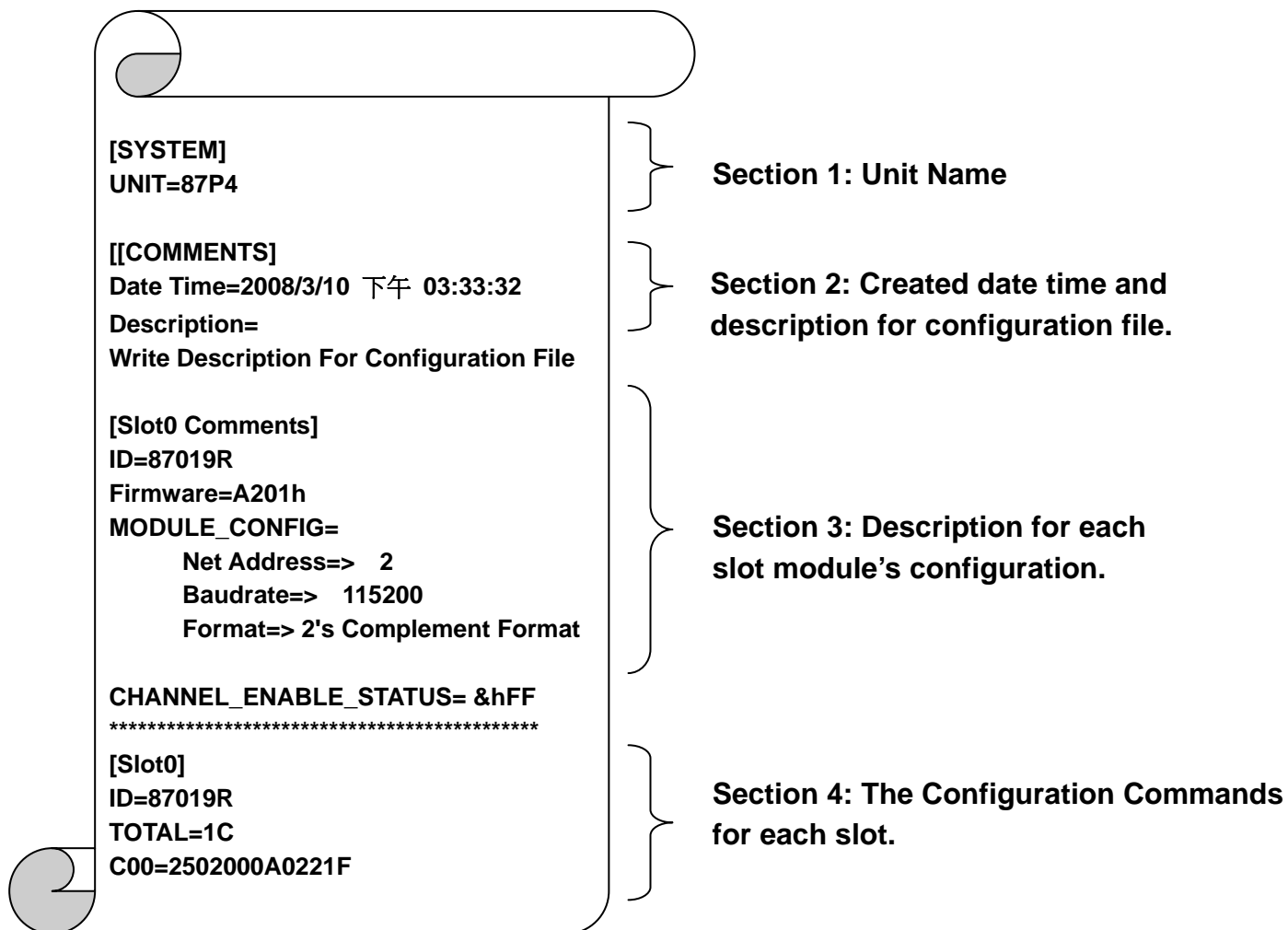

## Appendix E : Frame Ground

Electronic circuits are constantly vulnerable to Electro-Static Discharge (ESD), which become worse in a continental climate area. Some I-7000, M-7000 and I-8000 series modules feature a new design for the frame ground, which provides a path for bypassing ESD, allowing enhanced static protection (ESD) capability and ensures that the module is more reliable.

The following options will provide a better protection for the module:

The USB-87Pn controller has a metallic board attached to the back of the plastic basket as shown in the Figure 37 below. When mounted to the DIN rail, connect the DIN rail to the earth ground because the DIN rail is in contact with the upper frame ground as shown in the Figure 38 below

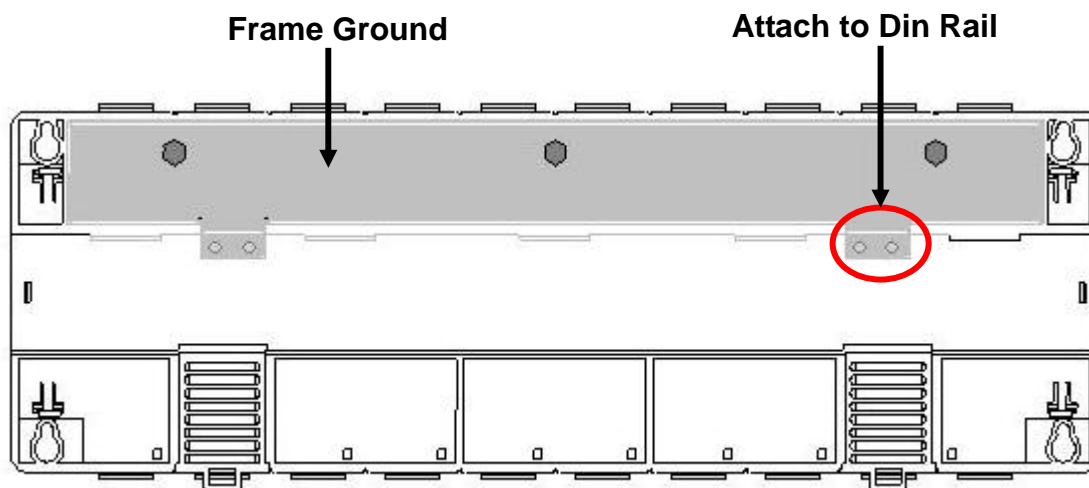

Fig. 29 : Frame Ground

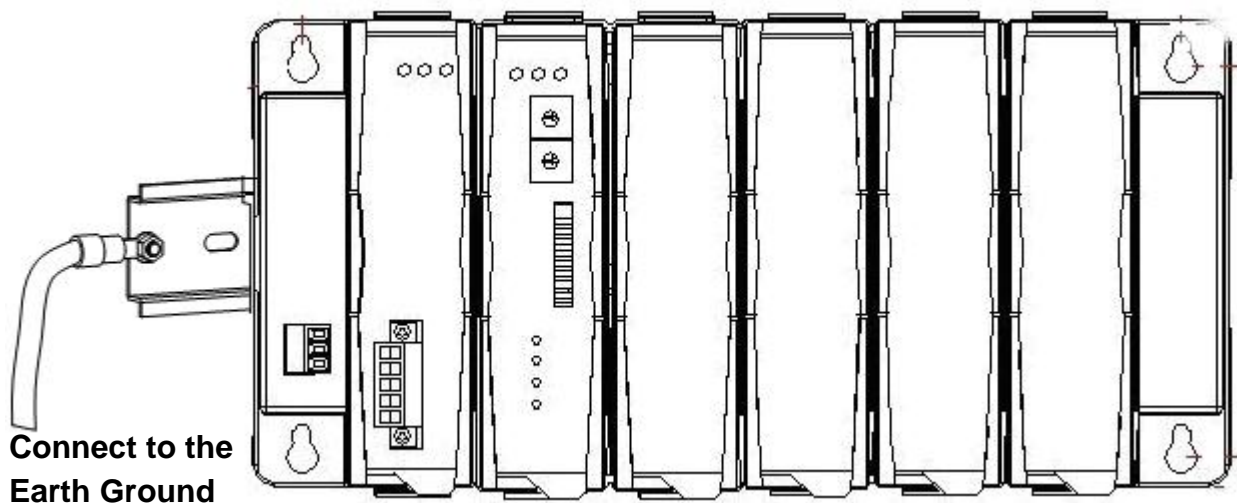

Fig. 30 : Connect to the Earth Ground