

***TECHNICAL MANUAL***  
***Of***  
***Intel 945GSE Express Chipset***  
***&***  
***Intel FW82801GBM ICH Chipset***  
***Based***  
***Mini-ITX M/B for ATOM Processor***

NO.G03-NF92-F

Rev 1.0

Release date: Oct., 2009

**Trademark:**

- \* Specifications and Information contained in this documentation are furnished for information use only, and are subject to change at any time without notice, and should not be construed as a commitment by manufacturer.

---

---

## Environmental Protection Announcement

Do not dispose this electronic device into the trash while discarding. To minimize pollution and ensure environment protection of mother earth, please recycle.



---

---

# TABLE OF CONTENT

ENVIRONMENTAL SAFETY INSTRUCTION .....	iv
USER'S NOTICE .....	v
MANUAL REVISION INFORMATION .....	v
ITEM CHECKLIST .....	v
<b>CHAPTER 1 INTRODUCTION OF THE MOTHERBOARD</b>	
1-1 FEATURE OF MOTHERBOARD .....	1
1-2 SPECIFICATION .....	2
1-3 LAYOUT DIAGRAM .....	3
<b>CHAPTER 2 HARDWARE INSTALLATION</b>	
2-1 JUMPER SETTING .....	7
2-2 CONNECTORS AND HEADERS .....	10
2-2-1 CONNECTORS .....	10
2-2-2 HEADERS .....	11
<b>CHAPTER 3</b>	
3-1 ENTERNING SETUP .....	19
3-2 GETTING HELP .....	19
3-3 THE MAIN MENU .....	19
3-4 STANDARD CMOS FEATURES .....	21
3-5 ADVANCED BIOS FEATURES .....	23
3-5-1 CPU FEATURES .....	25
3-6 ADVANCED CHIPSET FEATURES .....	26
3-7 INTEGRATED PHERIPHRALS .....	27
3-7-1 ONBOARD IDE FUNCTION .....	28
3-7-2 ONBOARD DEVICE FUNCTION .....	29
3-7-3 ONBOARD SUPERIO FUNCTION .....	30
3-8 POWER MANAGEMENT SETUP .....	32
3-9 PNP/PCI CONFIGURATION .....	34
3-10 PC HEALTH STATUS .....	35
3-11 MISCELLANEOUS CONTROL .....	36
3-12 PASSWORD SETTING .....	37



## Environmental Safety Instruction

---

- Avoid the dusty, humidity and temperature extremes. Do not place the product in any area where it may become wet.
- 0 to 60 centigrade is the suitable temperature. (The figure comes from the request of the main chipset)
- Generally speaking, dramatic changes in temperature may lead to contact malfunction and crackles due to constant thermal expansion and contraction from the welding spots' that connect components and PCB. Computer should go through an adaptive phase before it boots when it is moved from a cold environment to a warmer one to avoid condensation phenomenon. These water drops attached on PCB or the surface of the components can bring about phenomena as minor as computer instability resulted from corrosion and oxidation from components and PCB or as major as short circuit that can burn the components. Suggest starting the computer until the temperature goes up.
- The increasing temperature of the capacitor may decrease the life of computer. Using the close case may decrease the life of other device because the higher temperature in the inner of the case.
- Attention to the heat sink when you over-clocking. The higher temperature may decrease the life of the device and burned the capacitor.

---

---

## USER'S NOTICE

COPYRIGHT OF THIS MANUAL BELONGS TO THE MANUFACTURER. NO PART OF THIS MANUAL, INCLUDING THE PRODUCTS AND SOFTWARE DESCRIBED IN IT MAY BE REPRODUCED, TRANSMITTED OR TRANSLATED INTO ANY LANGUAGE IN ANY FORM OR BY ANY MEANS WITHOUT WRITTEN PERMISSION OF THE MANUFACTURER.

THIS MANUAL CONTAINS ALL INFORMATION REQUIRED TO USE THIS MOTHER-BOARD SERIES AND WE DO ASSURE THIS MANUAL MEETS USER'S REQUIREMENT BUT WILL CHANGE, CORRECT ANY TIME WITHOUT NOTICE. MANUFACTURER PROVIDES THIS MANUAL "AS IS" WITHOUT WARRANTY OF ANY KIND, AND WILL NOT BE LIABLE FOR ANY INDIRECT, SPECIAL, INCIDENTAL OR CONSEQUENTIAL DAMAGES (INCLUDING DAMAGES FOR LOSS OF PROFIT, LOSS OF BUSINESS, LOSS OF USE OF DATA, INTERRUPTION OF BUSINESS AND THE LIKE).

PRODUCTS AND CORPORATE NAMES APPEARING IN THIS MANUAL MAY OR MAY NOT BE REGISTERED TRADEMARKS OR COPYRIGHTS OF THEIR RESPECTIVE COMPANIES, AND THEY ARE USED ONLY FOR IDENTIFICATION OR EXPLANATION AND TO THE OWNER'S BENEFIT, WITHOUT INTENT TO INFRINGE.

## Manual Revision Information

Reversion	Revision History	Date
1.0	First Edition	Sept., 2009

## Item Checklist

- Motherboard
- Cable(s)
- DVD for motherboard utilities
- Motherboard User's Manual
- Back panel

---

---

# Chapter 1

## Introduction of the Motherboard

### 1-1 Feature of motherboard

- Intel 945GSE+ICH7M chipset.
- Onboard Atom CPU, with low power consumption never denies high performance.
- Support FSB 133 MHz.
- Support SO-DIMM DDRII 400/533 up to 2GB.
- Onboard Realtek RTL 8111DL Gigabit Ethernet LAN.
- Integrated ALC662 6-channel HD audio CODEC
- Support USB2.0 data transport demands.
- Support RS232/422/485 and watchdog.

---

---

## 1-2 Specification

Spec	Description
<b>Design</b>	<ul style="list-style-type: none"><li>● Mini-ITX form factor 6 layers ; PCB size: 17.0x17.0cm</li></ul>
<b>Chipset</b>	<ul style="list-style-type: none"><li>● Intel 945GSE+ICH7M Chipset</li></ul>
<b>Embedded CPU</b>	<ul style="list-style-type: none"><li>● ATOM CPU</li></ul>
<b>Memory Socket</b>	<ul style="list-style-type: none"><li>● 200-pin DDRII SO-DIMM slot x1</li><li>● Support DDRII 400/533MHz DDRII memory Modules</li><li>● Expandable to 2GB</li></ul>
<b>Expansion Slots</b>	<ul style="list-style-type: none"><li>● 32-bit PCI slot x 1pcs</li></ul>
<b>Integrate IDE</b>	<ul style="list-style-type: none"><li>● One PCI IDE controller that supports PCI Bus Mastering, ATA PIO/DMA and the ULTRA DMA 100/66 functions that deliver the data transfer rate up to 100 MB/s</li></ul>
<b>LAN</b>	<ul style="list-style-type: none"><li>● Integrated Realtek RTL8111DL PCI-E Gigabit LAN</li><li>● Support Fast Ethernet LAN function of providing 10Mb/100Mb/1000Mb Ethernet data transfer rate</li></ul>
<b>Audio</b>	<ul style="list-style-type: none"><li>● ALC662 6-channel Audio Codec integrated</li><li>● Audio driver and utility included</li></ul>
<b>BIOS</b>	<ul style="list-style-type: none"><li>● Award 8MB Flash ROM</li></ul>
<b>Multi I/O</b>	<ul style="list-style-type: none"><li>● Serial port connector x1</li><li>● VGA port connector x1</li><li>● USB port connector x2 and USB header x2</li><li>● RJ-45 LAN connector x1</li><li>● PS/2 keyboard connector x1</li><li>● HDTV out connector x1</li><li>● TV Out or Coaxial S/PDIF out connector x1</li><li>● Audio connector x1 (Line-in, Line-out, MIC)</li><li>● IDE1 x1</li><li>● SATAII x2</li><li>● LVDS header x1</li></ul>

- 
- 
- |  |  |
|--|--|
|  | <ul style="list-style-type: none"><li>● Audio header x1</li><li>● Serial port header x1</li><li>● RS422/RS485 header x1</li><li>● Parallel port header x1</li><li>● GPIO header x1</li></ul> |
|--|--|

### 1-3 Layout Diagram

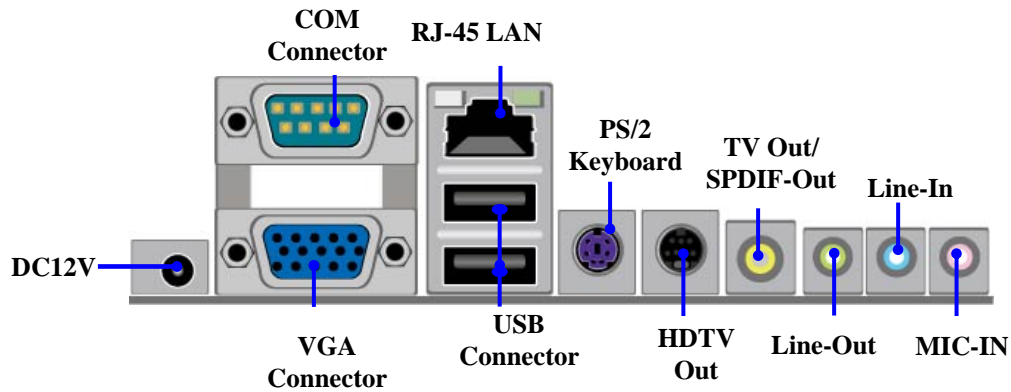



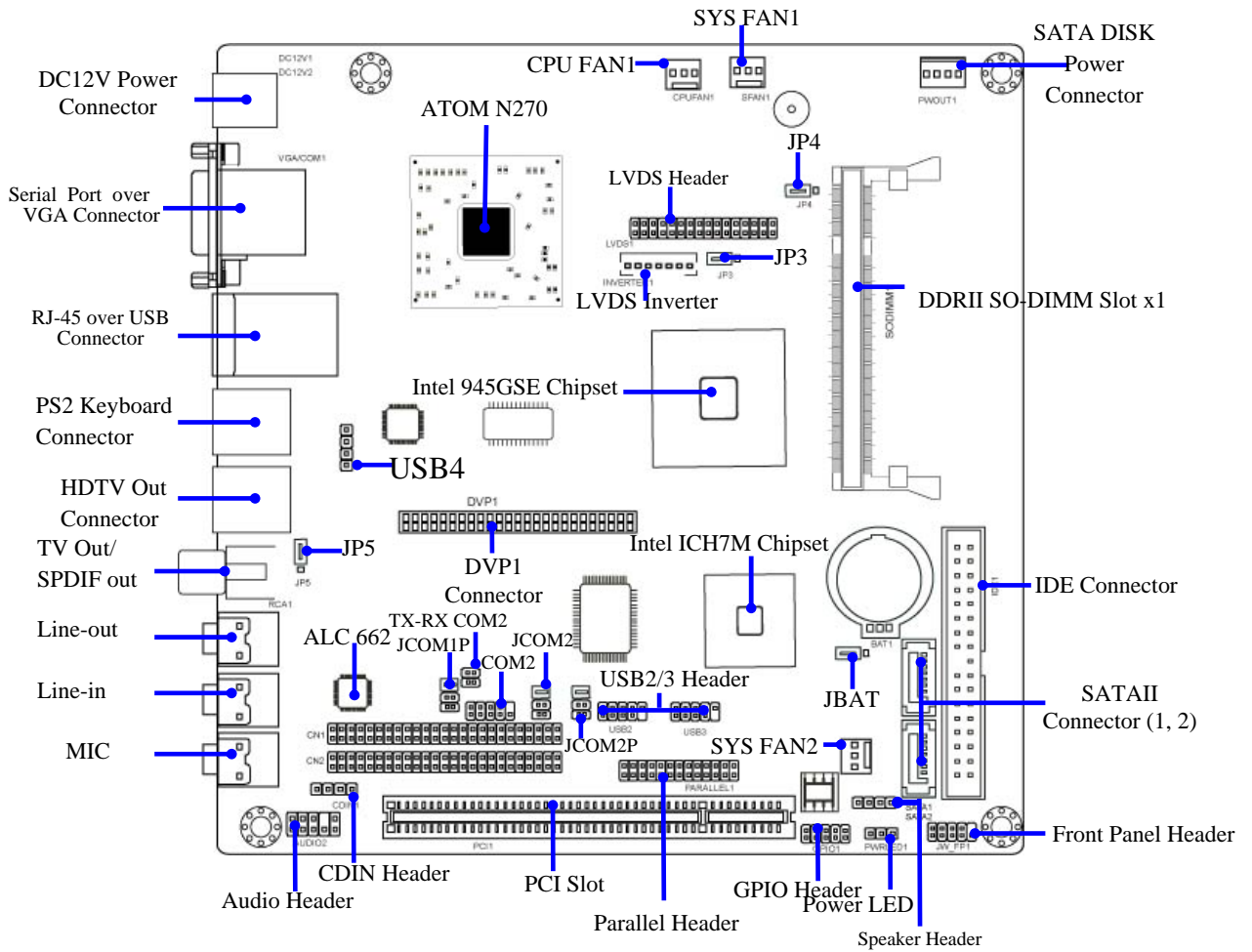

---

---

## ***Jumper***

<b>Jumper</b>	<b>Name</b>	<b>Description</b>
JBAT1	CMOS RAM Clear Function Setting	3-pin Block
JP3	Inverter VCC 12V/5V Select	3-pin Block
JP4	LVDS VCC 5V/3.3V Select	3-pin Block
JP5	TV Out/SPDIF Out Settings	3-pin Block
JCOM2	COM2 RS232/422/485 Function Select	6pin Block
JCOM1P	Power RS232 Function Select	6pin Block
JCOM2P	Power RS232 Function Select	6pin Block

## ***Connectors***

<b>Connector</b>	<b>Name</b>	<b>Description</b>
PWOUT1	Power out Connector	4-pin Connector
SATA1/SATA2	Serial ATAII Connector	7-pin Connector
DC12V1	DC power Connector	DC Jack
VGA1	Video Graphic Attach Connector	15-pin Female
COM1	Serial Port COM Connector	9-pin Connector
USB from UL1	USB Port Connectors	4-pin Connectors
LAN from UL1	RJ-45 LAN Connectors	8-pin Connectors
PS2-KB1	PS2 Keyboard Connector	6-pin Female
HDTV1	HDTV out Connector	7-pin Female
RCA1	TV Out or Coaxial SPDIF_OUT Connector	1-RCA Connector
AUDIO1	Line Out/Line In/MIC Connector	3 Phone JACK

---

---

## Headers

Header	Name	Description
AUDIO2	Front panel audio Headers	9-pin block
CDIN1	CD Audio-In Header	4-pin Block
LVDS1	LVDS Connector	32-pin Block
INVERTER1	LVDS Inverter Connector	7-pin Block
CN1; CN2	Jetway Daughter Card Connector	50-pin *2 Block
COM2	Serial Port Header	9-pin Block
TX-RX COM2	RS422/485 port headers	4-pin block
USB2; USB3	USB Headers	9-pin Block
PARALLEL	Parallel Header	25-pin Block
JW_FP1 (PWR LED/ HD LED/ /Power Button /Reset)	Front Panel Header (PWR LED/ HD LED/ /Power Button /Reset)	9-pin Block
PWR LED1	Power LED	3-pin Block
SPEAK	Speaker Header	4-pin Block
CPUFAN,SFAN1/2	FAN Speed Headers	3-pin Block
GPIO1	GPIO header	10-pin Connector
USB4	USB Headers	4-pin block
DVP1	Jetway Daughter Card Headers	50pin Block block

---

---

# Chapter 2

## Hardware Installation

### 2-1 Jumper Setting

#### (1) Clear CMOS (3-pin): JBAT

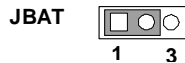
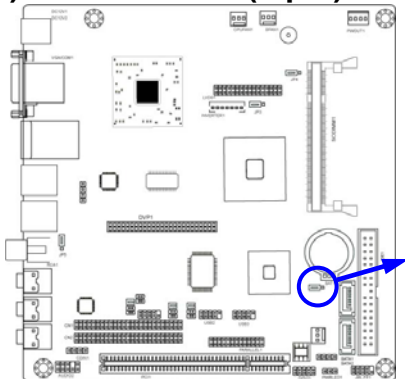

1-2 closed Normal

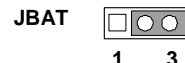

2-3 closed Clear CMOS

CMOS RAM Clear Setting

#### (2) JP3: Inverter VCC 5V/12Vselect (3-pin)

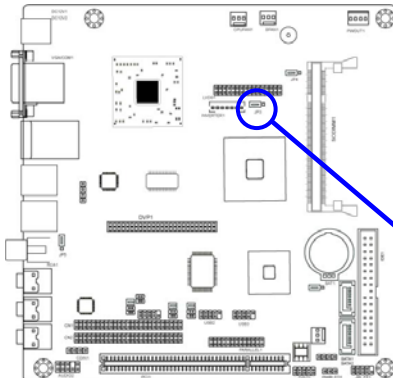

1-2 Closed  
Inverter 12V selected



2-3 closed  
Inverter 5V select

---

---

**(3) JP4: LVDS VCC 5V/3.3V Function setting (3-pin)**

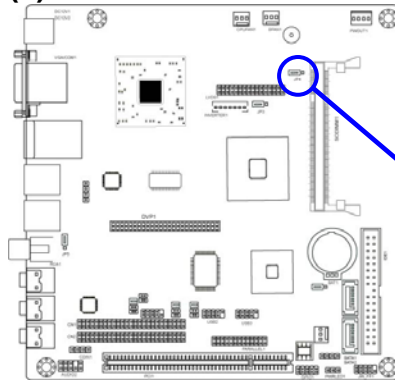

JP4



1-2 closed: LVDS VCC 5V

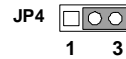

2-3 closed : LVDS VCC 3.3V

**(4) JP5: TV out/SPDIF out setting (3-pin)**

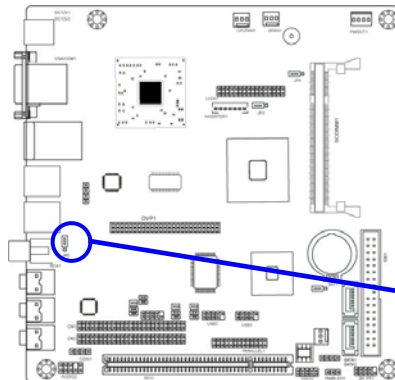

JP5



1-2 closed:TV Out Select



2-3 closed :SPDIF Out Select

---

---

### (5) JCOM2: COM2 port RS232/485/422 Function Select

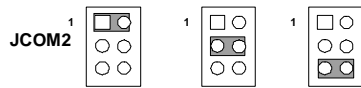
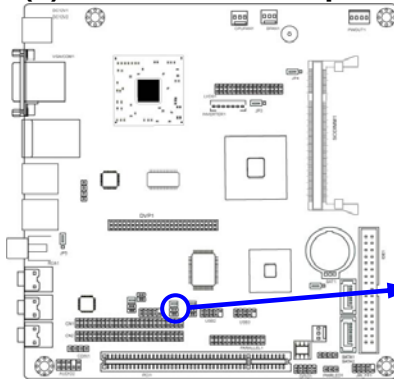

1-2 closed: RS232    3-4 closed : RS485    5-6 closed : RS422

### (6) JCOM1P: COM1 Pin9 function select

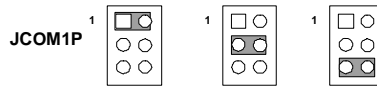
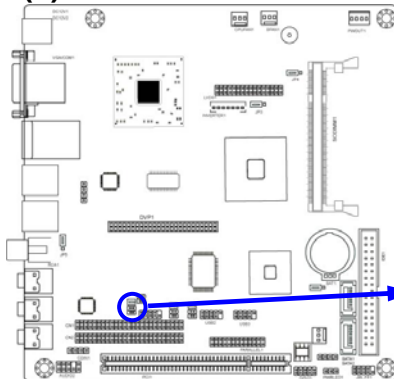

1-2 closed: RS232    3-4 closed : +12V    5-6 closed : +5V

---

---

**(7) JCOM2P: COM2 Pin9 function select**

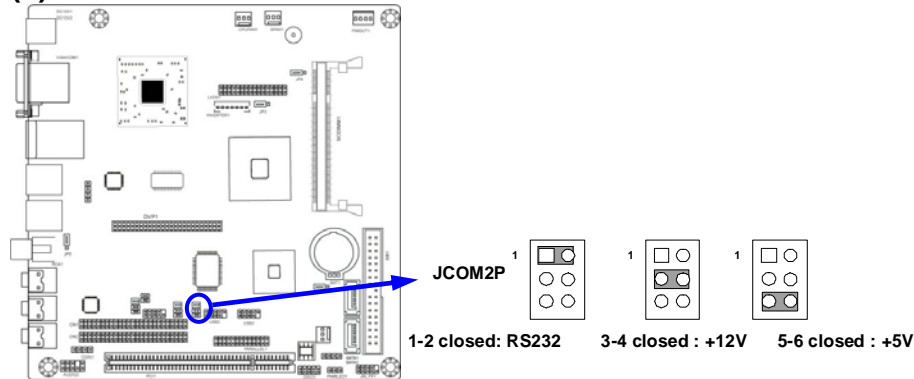

## **2-2 Connectors and Headers**

### **2-2-1 Connectors**

**(1) Audio Connector: (Line-IN/ Line-Out/ MIC-In)**

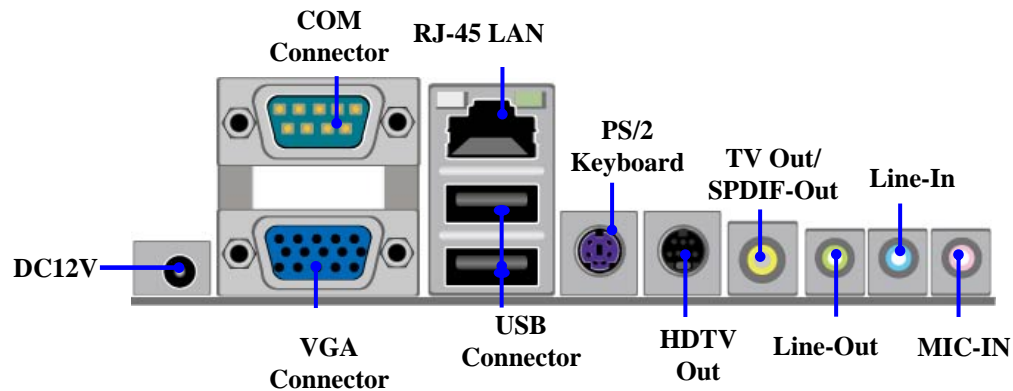

---

---

## (2) Serial-ATA Port connector: SATA1/SATA2

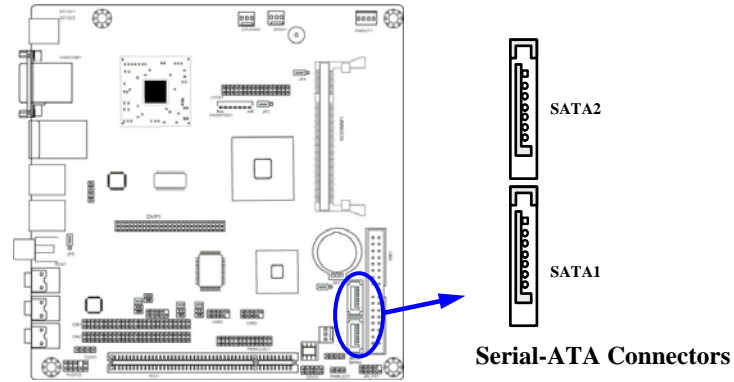

## 2-2-2 Headers

### (1) Front panel audio (9-pin): AUDIO2

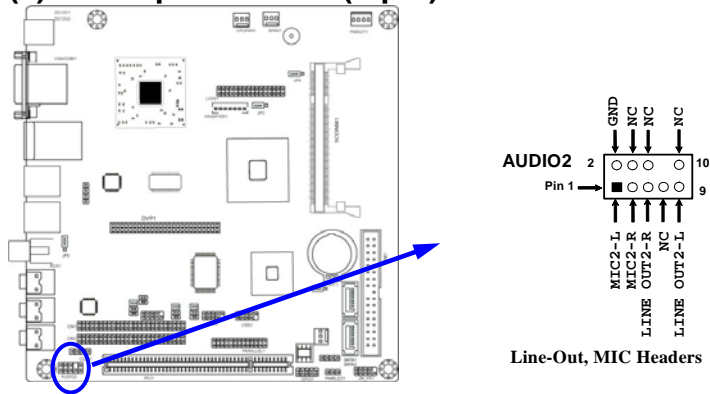



**(2) CD AUDIO-In Headers (4-pin): CDIN1**

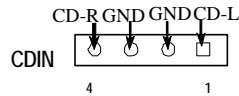
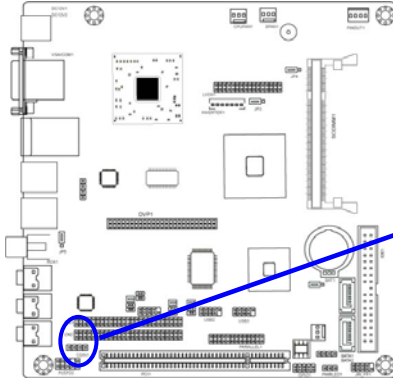

**CD Audio-In Headers**

**(3) LVDS Headers: LVDS1**

Pin NO.	Pin Define	Pin NO.	Pin Define
Pin 1	NC	Pin 2	NC
Pin 3	LVDS_CLKBN	Pin 4	LVDS_CLKBP
Pin 5	LVDSB_DATAN2	Pin 6	LVDSB_DATAP2
Pin 7	LVDSB_DATAN1	Pin 8	LVDSB_DATAP1
Pin 9	LVDSB_DATAN0	Pin 10	LVDSB_DATAP0
Pin 11	LVDS_DDC_DATA	Pin 12	LVDS_DDC_CLK
Pin 13	GND	Pin 14	GND
Pin 15	GND	Pin 16	GND
Pin 17	NC	Pin 18	NC
Pin 19	LVDS_CLKAP	Pin 20	LVDS_CLKAN
Pin 21	LVDSB_DATAP2	Pin 22	LVDSB_DATAN2
Pin 23	LVDSB_DATAP1	Pin 24	LVDSB_DATAN1
Pin 25	LVDSB_DATAP0	Pin 26	LVDSB_DATAN0

Pin 27	VCC	Pin 28	VCC
Pin 29	VCC	Pin 30	VCC
Pin 31	GND	Pin 32	GND

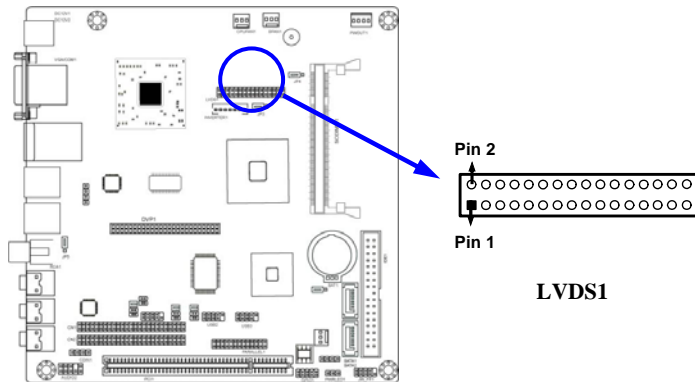

#### (4) LVDS Inverter headers: Inverter1

Pin 1 and pin2: VCC of inverter

Pin3, pin4 and pin6: GND

Pin5: Backlight

Pin7: Brightness

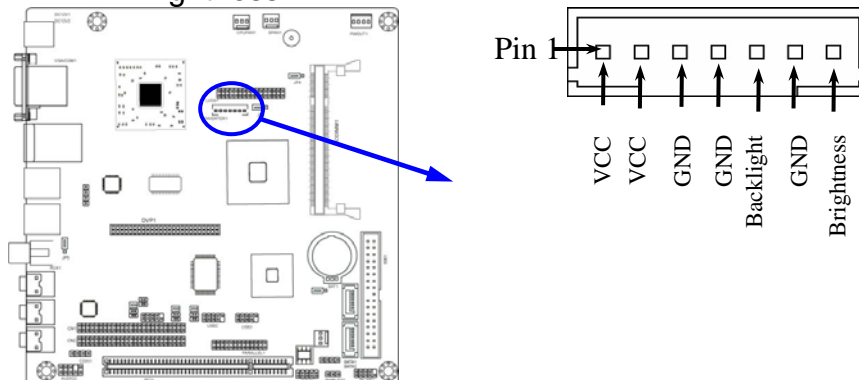

---

---

**(5) COM Port Connectors: COM2**

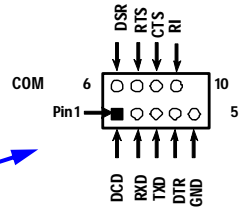
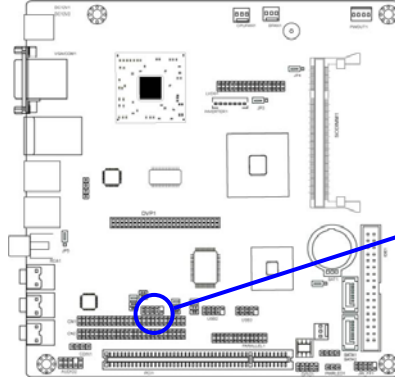

**COM Connector**

**(6) RS422/485 Header: TX-RXCOM2**

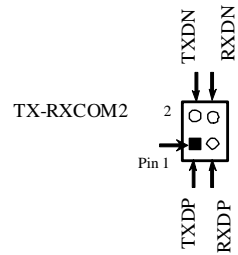
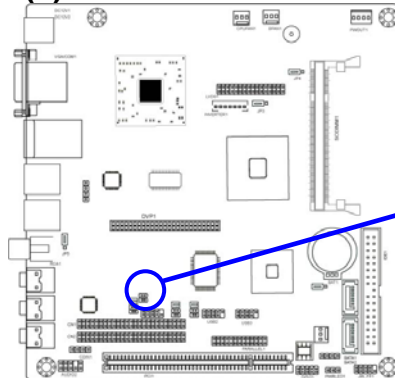

**TX-RXCOM2 Header**

---

**(7) USB Port Headers (9-pin): USB2/USB3**

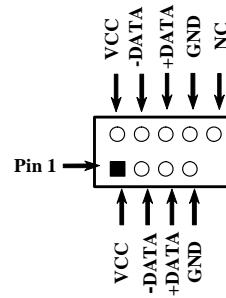
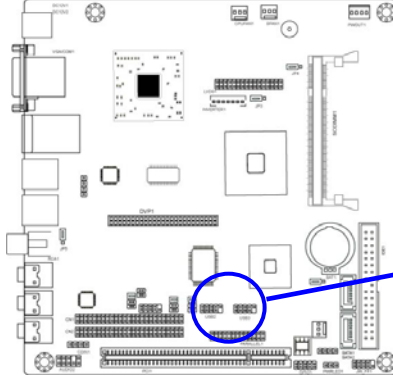

USB Port Header

**(8) USB Port Headers (4-pin): USB4**

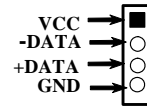
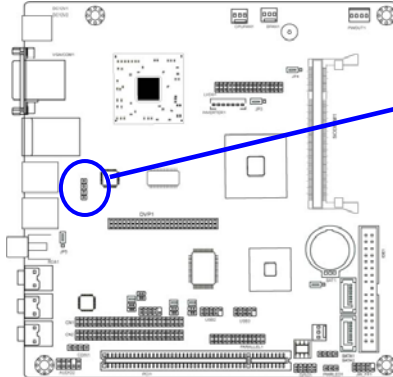

USB Port Header

## (9) Front Panel Header: JW-FP1

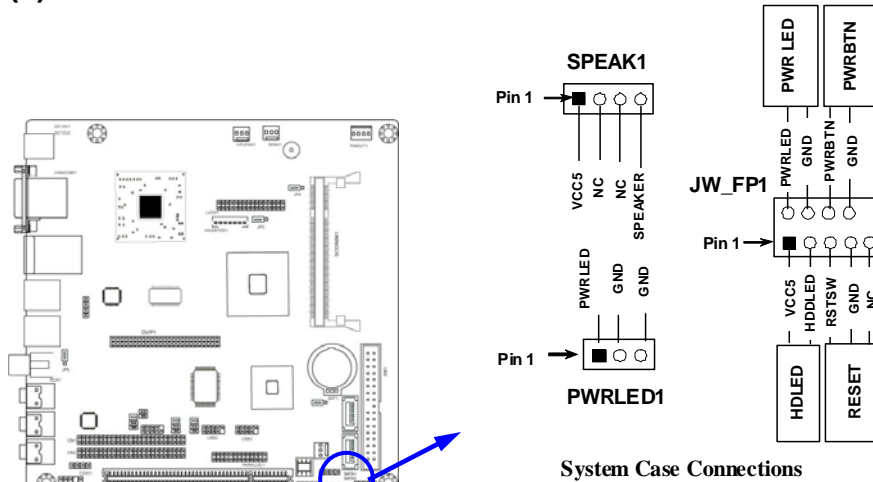

## (10) FAN Speed Headers (3-pin): CPUFAN1, SFAN1/SFAN2

Pin1: GND

Pin2: +12V fan power

Pin3: Fan Speed

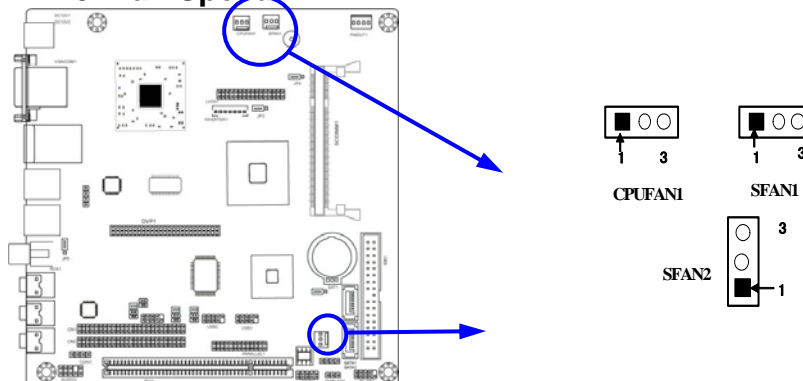

---

---

**(11) GPIO Connectors (9-pin): GPIO1**

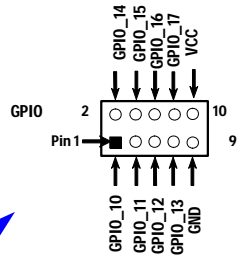
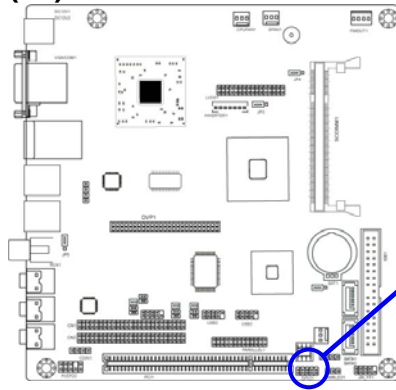

**GPIO1 Connector**

---

---

## Chapter 3

### Introducing BIOS

**Notice!** The BIOS options in this manual are for reference only. Different configurations may lead to difference in BIOS screen and BIOS screens in manuals are usually the first BIOS version when the board is released and may be different from your purchased motherboard. Users are welcome to download the latest BIOS version form our official website.

The BIOS is a program located on a Flash Memory on the motherboard. This program is a bridge between motherboard and operating system. When you start the computer, the BIOS program will gain control. The BIOS first operates an auto-diagnostic test called POST (power on self test) for all the necessary hardware, it detects the entire hardware device and configures the parameters of the hardware synchronization. Only when these tasks are completed done it gives up control of the computer to operating system (OS). Since the BIOS is the only channel for hardware and software to communicate, it is the key factor for system stability, and in ensuring that your system performance as its best.

In the BIOS Setup main menu of Figure 3-1, you can see several options. We will explain these options step by step in the following pages of this chapter, but let us first see a short description of the function keys you may use here:

- Press <Esc> to quit the BIOS Setup.
- Press ↑↓←→ (up, down, left, right) to choose, in the main menu, the option you want to confirm or to modify.

- 
- 
- Press <F10> when you have completed the setup of BIOS parameters to save these parameters and to exit the BIOS Setup menu.
  - Press Page Up/Page Down or +/- keys when you want to modify the BIOS parameters for the active option.

### **3-1 Entering Setup**

Power on the computer and by pressing <Del> immediately allows you to enter Setup. If the message disappears before your respond and you still wish to enter Setup, restart the system to try again by turning it OFF then ON or pressing the “RESET” button on the system case. You may also restart by simultaneously pressing <Ctrl>, <Alt> and <Delete> keys. If you do not press the keys at the correct time and the system does not boot, an error message will be displayed and you will again be asked to

**Press <Del> to enter Setup**

### **3-2 Getting Help**

#### **Main Menu**

The on-line description of the highlighted setup function is displayed at the bottom of the screen.

#### **Status Page Setup Menu/Option Page Setup Menu**

Press F1 to pop up a small help window that describes the appropriate keys to use and the possible selections for the highlighted item. To exit the Help Window, press <Esc>.

### **3-3 The Main Menu**

Once you enter Award® BIOS CMOS Setup Utility, the Main Menu (Figure 3-1) will appear on the screen. The Main Menu allows you to select from fourteen setup functions and two exit choices. Use arrow keys to select among the items and press <Enter> to accept or enter the sub-menu.





Figure 3-1

### **Standard CMOS Features**

Use this Menu for basic system configurations.

### **Advanced BIOS Features**

Use this menu to set the Advanced Features available on your system.

### **Advanced Chipset Features**

Use this menu to change the values in the chipset registers and optimize your system's performance.

### **Integrated Peripherals**

Use this menu to specify your settings for integrated peripherals.

### **Power Management Setup**

---

---

Use this menu to specify your settings for power management.

**PnP/PCI Configurations**

Use this menu to specify your settings for PnP and PCI configurations.

**PC Health Status**

This entry shows your PC health status.

**Miscellaneous Control**

Use this menu to specify your settings for Miscellaneous Control.

**Load Optimized Defaults**

Use this menu to load the BIOS default values these are setting for optimal performances system operations for performance use.

**Load Standard Defaults**

Use this menu to load the BIOS default values for the minimal/stable performance system operation

**Set Supervisor Password**

Use this menu to set supervisor password.

**Set User Password**

Use this menu to set user password.

**Save & Exit Setup**

Save CMOS value changes to CMOS and exit setup.

**Exit Without Saving**

Abandon all CMOS value changes and exit setup.

### **3-4 Standard CMOS Features**

The items in Standard CMOS Setup Menu are divided into several categories. Each category includes no, one or more than one setup items. Use the arrow keys to highlight the item and then use the <PgUp> or <PgDn> keys to select the value you want in each item.



## Date

The date format is <day><month><date><year>.

**Day** Day of the week is from Sun to Sat, determined by BIOS. Read-only.

**Month** The month is from Jan. through Dec.

**Date** The date from 1 to 31 can be keyed by numeric function keys.

**Year** The year depends on the year of the BIOS.

## Time

The time format is <hour><minute><second>.

### SATA Port1 Master/SATA Port 2 Master/IDE Channel Master/Slave

Press Enter to enter the subitem and then press PgUp/<+> or PgDn/<-> to select None, Auto type. Note that the specifications of your drive must match with the drive table. If the controller of HDD interface is SCSI, the selection shall be "None".

If the controller of HDD interface is CD-ROM, the selection shall be "None"

**Access Mode** The settings are CHS, LBA, Large and Auto.

**Capacity**        The capacity of the hard disk driver.  
**Cylinder**        number of cylinders  
**Head**             number of heads  
**Precomp**         write precomp  
**Landing Zone**    landing zone  
**Sector**          number of sectors

**Video**

The optional settings are: EGA/VGA; CGA40; CGA80;MONO.

**Halt On**

Three optional settings are: All Errors; No Errors; All, But Keyboard.

### 3-5 Advanced BIOS Features

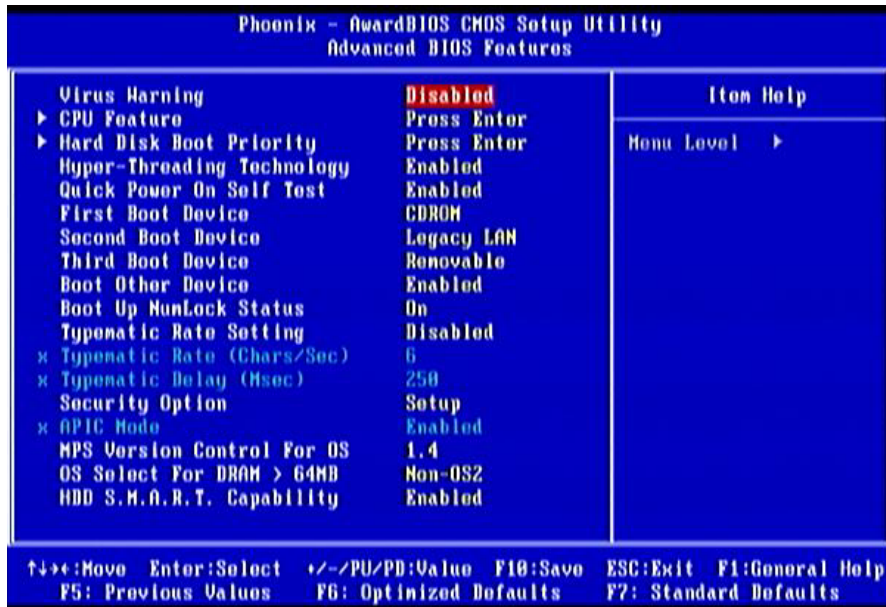

---

---

## **Virus Warning**

The selection Allow you to choose the VIRUS Warning feature for IDE Hard Disk boot sector protection. If this function is enabled and someone attempt to write data into this area, BIOS will show a warning message on screen and alarm beep.

**Disabled** (default) No warning message to appear when anything attempts to access the boot sector or hard disk partition table.

**Enabled** Activates automatically when the system boots up causing a warning message to appear when anything attempts to access the boot sector of hard disk partition table.

## **Hard Disk Boot Priority**

The selection is for you to choose the hard disk drives priorities to boot from.

### **Quick Power On Self-Test**

This category speeds up Power On Self Test (POST) after you power on the computer. If this is set to Enabled, BIOS will shorten or skip some check items during POST.

**Enabled** (default) Enable quick POST

**Disabled** Normal POST

### **First/Second/Third Boot... Device**

The BIOS attempts to load the operating system from the devices in the sequence selected in these items. The optional settings are Removable; Hard Disk; CDROM; Legacy LAN and Disabled.

### **Boot Up NumLock Status**

The default value is On.

**On** (default) Keypad is numeric keys.

**Off** Keypad is arrow keys.

### **Typematic Rate Setting**

Keystrokes repeat at a rate determined by the keyboard controller. When enabled, the typematic rate and typematic delay can be selected. The settings are: Enabled/Disabled.

### **Typematic Rate (Chars/Sec)**

Sets the number of times a second to repeat a keystroke when you hold the key down. The settings are: 6, 8, 10, 12, 15, 20, 24, and 30.

---

---

### Typematic Delay (Msec)

Sets the delay time after the key is held down before beginning to repeat the keystroke. The settings are 250, 500, 750, and 1000.

### Security Option

This category allows you to limit access to the system and Setup, or just to Setup.

**System** The system will not boot and access to Setup will be denied if the correct password is not entered at the prompt.

**Setup (default)** The system will boot, but access to Setup will be denied if the correct password is not entered prompt.

### MPS Version Control for OS

This option is only valid for multiprocessor motherboards as it specifies the version of the Multiprocessor Specification (MPS) that the motherboard will use.

### OS Select for DRAM > 64MB

Allows OS2® to be used with >64MB or DRAM. Settings are Non-OS/2 (default) and OS2. Set to OS/2 if using more than 64MB and running OS/2®.

### HDD S.M.A.R.T Capability

This option allow you to enable the HDD S.M.A.R.T Capability (Self-Monitoring, Analysis and Reporting Technology) . You can choose from Enabled and Disabled.

## 3-5-1 CPU Features



### Limit CPUID Maxval

This option support the max ID of comparatively old processor.

---

---

### CPU C State Compatibility

The optional settings are: Disabled; C2; C4.

### Enhanced Intel Speedstep Tech

This option can provide average power savings depending on system usage and design.

## 3-6 Advanced Chipset Features

The Advanced Chipset Features Setup option is used to change the values of the chipset registers. These registers control most of the system options in the computer.



### DRAM Timing Selectable

The optional settings are: By SPD; Manual. If you chose Manual, you could activate the four items following it and make modification manually.

### System BIOS Cacheable

---

---

Selecting Enabled allows caching of the system BIOS ROM at F0000h-FFFFFh, resulting in better system performance. However, if any program writes to this memory area, a system error may result. The settings are: Enabled and Disabled.

#### **OnChip Frame Buffer Size**

The optional settings are: 1MB; 8MB.

#### **DVMI/FIXED Monitor Size**

The optional values are: 64 MB; 128MB; 224 MB.

#### **Add-on Display Card**

The optional settings are: Disabled; CRT; DVI/HDMI and LVDS.

#### **DVMT Mode**

The optional settings are: FIXED; DVMI; BOTH.

#### **Boot Display**

The optional settings are: Auto; CRT; TV; LCD; CRT+LCD; Add On; CRT+Add On.

#### **DVMT/FIXED Memory Size**

The optional settings are: 64 MB; 128MB; 224MB.

### **3-7 Integrated Peripherals**

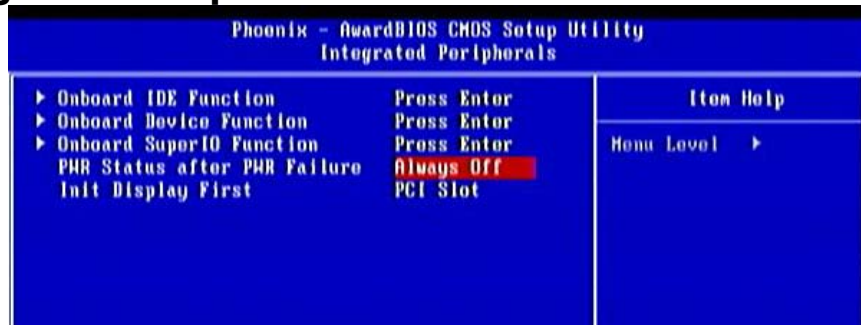

#### **PWR Status after PWR Failure**

The optional settings are: Former Status; Always On; Always Off.

#### **Init Display First**

The optional settings are: PCI slot; On-chip VGA.



---

---

## 3-7-1 Onboard IDE Function



### IDE Master/Slave PIO

The two IDE PIO (Programmed Input/Output) fields let you set a PIO mode for each of the two IDE devices that the onboard IDE interface supports. Modes 0 through 4 provide successively increased performance. In Auto mode, the system automatically determines the best mode for each device. The settings are: Auto, Mode 0, Mode 1, Mode 2, Mode 3, Mode 4.

### IDE Master/Slave UDMA

Ultra DMA133 implementation is possible only if your IDE hard drive supports it and the operating environment includes a DMA driver (Windows 95 OSR2 or a third-party IDE bus master driver). If your hard drive and your system software both support Ultra DMA133, select Auto to enable BIOS support. The settings are: Auto, Disabled.

---

---

### IDE DMA Transfer Access

The integrated peripheral controller contains an IDE interface with support for one IDE channels. Select Enabled to activate each channel separately. The settings are: Enabled and Disabled.

### IDE HDD Block Mode

Block mode is also called block transfer, multiple commands, or multiple sector read/write. If your IDE hard drive supports block mode (most new drives do), select Enabled for automatic detection of the optimal number of block read/writes per sector the drive can support. The settings are: Enabled, Disabled.

### Delay for HDD (Sec.)

The optional settings range from 0 to 15 seconds.

### SATA Port Speed Settings

The optional settings are: Disabled; Force GENI; Force GEN II.

## 3-7-2 Onboard Device Function



---

---

## High Definition Audio

This item allows you to decide to enable/disable the chipset family to support HD Audio. The settings are: Enabled, Disabled.

## Onboard PCIE Lan Bootrom

Decide whether to invoke the boot ROM of the onboard LAN chip.

## USB 2.0 Function /Keyboard/Mouse /Storage Support

Select *Enabled* if your system contains a Universal Serial Bus (USB) controller and you have a USB mouse /keyboard/USB storage device. The settings are: Enabled, Disabled.

## 3-7-3 Onboard SuperIO Function



## Onboard Serial Port 1/2

The optional settings are: Disabled, 3F8/IRQ4, 2F8/IRQ3, 3E8/IRQ4, 2E8/IRQ3; SE8/IRQ4; 4E8/IRQ3.

---

---

### **Onboard Serial Port 2 Mode**

The optional settings are: RS232; RS422 /RS485.

### **UART2 Mode Select**

This item allows you to determine which InfraRed(IR) function of the onboard I/O chip. The optional settings are: Normal; IrDA.

### **Onboard Parallel Port**

The optional settings are: Disabled, 378/IRQ7; 278/IRQ5 ;3BC/IRQ7.

### **Parallel Port Mode**

SPP : Standard Parallel Port

EPP : Enhanced Parallel Port

ECP : Enhanced Com Port

### **ECP +EPP**

To operate the onboard parallel port as Standard Parallel Port only, choose “SPP.” To operate the onboard parallel port in the EPP modes simultaneously, choose “EPP.” By choosing “ECP”, the onboard parallel port will operate in ECP mode only. Choosing “ECP+EPP” will allow the onboard parallel port to support both the ECP and EPP modes simultaneously. The ECP mode has to use the DMA channel, so choose the onboard parallel port with the ECP feature. After selecting it, the following message will appear: “ECP Mode Use DMA” at this time, the user can choose between DMA channels 3 to 1.

### **Watchdog Timer Select**

This item is used to activate the watchdog function. The optional settings are: Enabled; Disabled. When set it as Enabled user can choose configuration figures in subitems.

### **Watchdog Timer Value**

This item is only activated when Watchdog Timer Select is set as Enabled and users can set a value from the range of 0~255

---

---

## Watchdog Timer Unit

This item is only activated when Watchdog Timer Select is set as Enabled and the optional units are: Sec.;Min.

\*Note: User needs an additional Watchdog Programming Reference Code to make use of this BIOS function. Detailed procedures please download from our website if necessary.

## 3-8 Power Management Setup

The Power Management Setup allows you to configure your system to most effectively save energy saving while operating in a manner consistent with your own style of computer use.

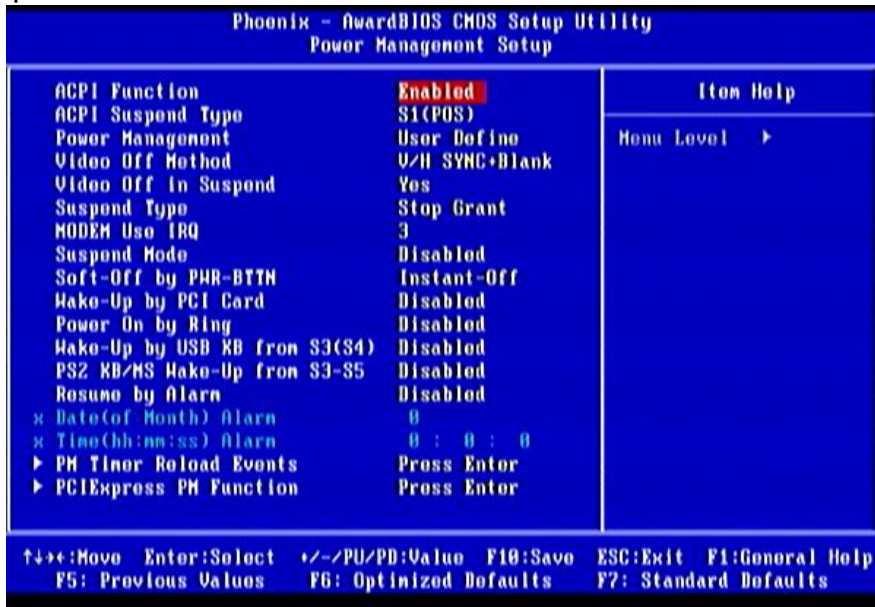

### ACPI Function

This item allows you to Enabled/Disabled the Advanced Configuration and Power Management (ACPI). The settings are Enabled and Disabled.

---

---

### **ACPI Suspend Type**

Use this item to select ACPI suspend type. The optional settings are: S1(POS); S3 (STR).

### **Power Management**

The optional settings are: User Define; Min Saving; Max Saving.

### **Video Off Method**

This determines the manner in which the monitor is blanked.

**Blank Screen** This option only writes blanks to the video buffer.

**V/H SYNC+Blank** This selection will cause the system to turn off the vertical and horizontal synchronization ports and write blanks to the video buffer.

**DPMS** Initial display power management signaling.

### **Video Off in Suspend**

The optional settings are: No; Yes.

### **Suspend Type**

The optional settings are: Stop Grant; PwrOn Suspend.

### **Suspend Mode**

The optional settings are Disabled; and setting range from 1 Min. to 1 Hour.

### **MODEM Use IRQ**

If you want an incoming call on a modem to automatically resume the system from a power-saving mode, use this item to specify the interrupt request line (IRQ) that is used by the modem. You might have to connect the fax/modem to the motherboard Wake On Modem connector for this feature to work.

### **Soft-Off by PWRBTN**

Under ACPI (Advanced Configuration and Power management Interface) you can create a software power down. In a software power down, the system can be resumed by Wake up Alarms. This item lets you install a software power down that is controlled by the power Button on your system. If the item is set to Instant-Off, then the power button causes a software power down. If the item is set to Delay 4 Sec, then you have to hold the power button down for four seconds to cause a software power down.

### **Wake Up Events**

---

---

Users can press Enter to select the relative items for wake up events. Set it as Disabled or Enabled in Wake-Up by USB KB from S3(S4); PS2 KB/MS Wake-Up from S3-S5

### Resume by Alarm

When set to Enabled, additional fields become available and you can set the date (day of the month), hour, minute and second to turn on your system. When set to 0 (zero) for the day of the month, the alarm will power on your system every day at the specified time .

#### Date (of month)

You can choose which month the system will boot up. Set to 0, to boot every day. The optional settings range from 0 to 31

#### Time (hh:mm:ss)

You can choose what hour, minute and second the system will boot up.

**Note:** If you have change the setting, you must let the system boot up until it goes to the operating system, before this function will work.

## 3-9 PnP/PCI Configuration

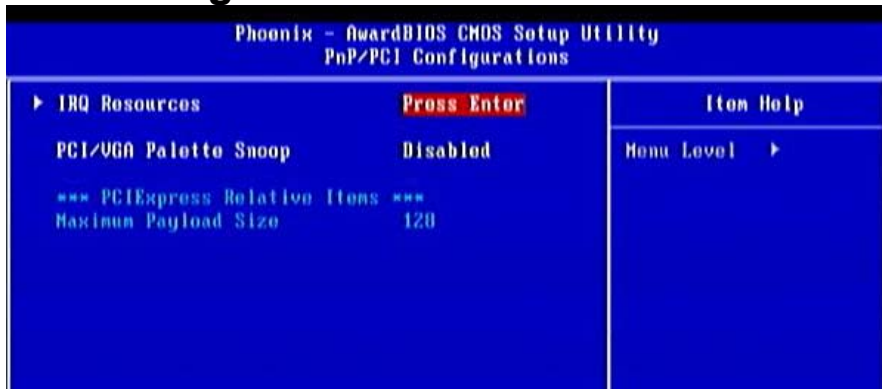

### IRQ Resources

Names the interrupt request (IRQ) line assigned to the USB on your system. Activity of the selected IRQ always awakens the system.

---

---

### PCI/VGA Palette Snoop

This item is designed to overcome problems that can be caused by some non-standard VGA cards. This board includes a built-in VGA system that does not require palette snooping so you must leave this item disabled.

### 3-10 PC Health Status

This section shows the Status of you CPU, Fan, and Warning for overall system status. This is only available if there is Hardware Monitor onboard.

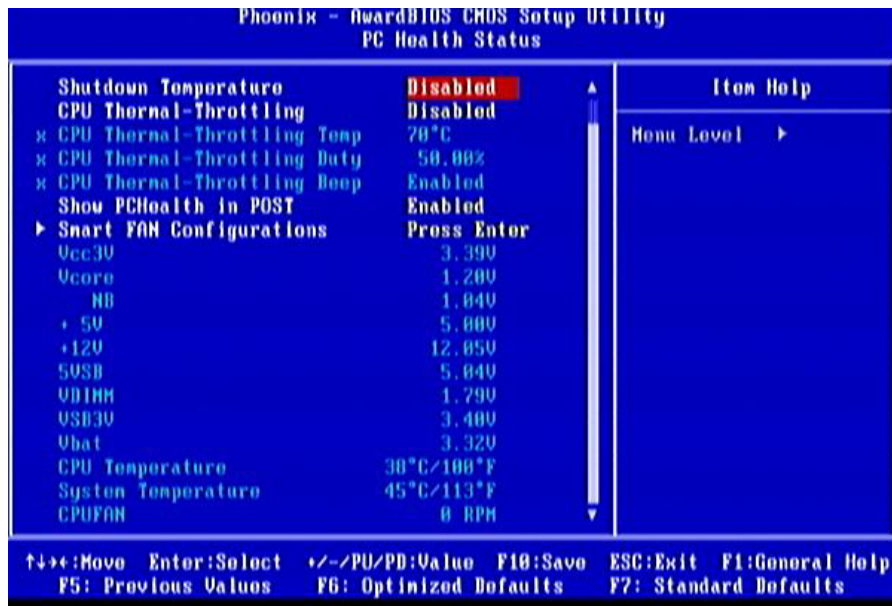

#### Shutdown Temperature

This item can let users setting the Shutdown temperature, when CPU temperature over this setting the system will auto shutdown to protect CPU.

#### Show PC Health in Post

During Enabled, it displays information list below. The choice is either Enabled or Disabled



---

---

### CPU Thermal Throttling

The optional settings are: Disabled; Enabled. When it is set as Enabled user could set value for CPU Thermal-Throttling Temp.; CPU Thermal-Throttling Duty and CPU Thermal-Throttling Beep.

### Smart Fan Configuration

Press Enter to set certain values for the following three items: CPUFAN Smart Mode; SYSFAN1 Smart Mode; SYSFAN2 Smart Mode. Select Enabled in each item to set the value.

### VCC3V/Vcore/ /NB/+5V/+12V/5 VSB/VDIMM/VSB3V/Vbat/ CPU Temperature/ System Temperature/CPUFAN/ SYSFAN1/SYSFAN2 Speed...

This will show the CPU/FAN/System voltage chart and FAN Speed, etc..

## 3-11 Miscellaneous Control

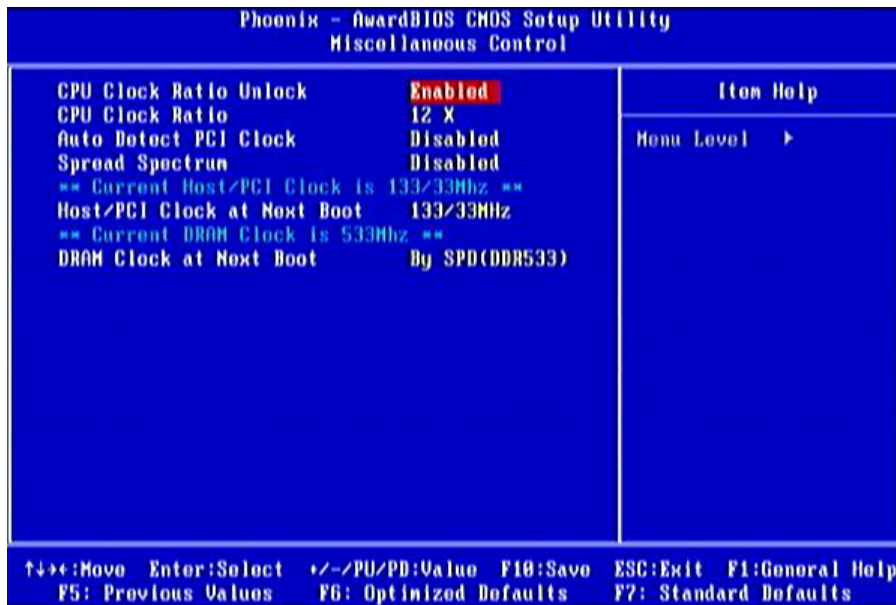

### CPU Clock Ratio Unlock

This item is used to lock or unlock CPU ratio.

---

---

---

## CPU Clock Ratio

The optional settings range from 6X to 12X.

## DRAM Clock at Next Boot

This item allows you to set DRAM clock. The optional settings are: DDR400; DDR533; By SPD (DDR533).

## 3-12 Password Setting

You can set either supervisor or user password, or both of them. The differences are:

**Supervisor password:** Can enter and change the options of the setup menus.

**User password:** Can only enter but do not have the right to change the options of the setup menus. When you select this function, the following message will appear at the center of the screen to assist you in creating a password.

### ENTER PASSWORD:

Type the password, up to eight characters in length, and press <Enter>. The password typed now will clear any previously entered password from CMOS memory. You will be asked to confirm the password. Type the password again and press <Enter>. You may also press <Esc> to abort the selection and not enter a password.

To disable a password, just press <Enter> when you are prompted to enter the password. A message will confirm that the password will be disabled. Once the password is disabled, the system will boot and you can enter Setup freely.

### PASSWORD DISABLED.

When a password has been enabled, you will be prompted to enter it every time you try to enter Setup. This prevents an unauthorized person from changing any part of your system configuration.

Additionally, when a password is enabled, you can also require the BIOS to request a password every time your system is rebooted. This would prevent unauthorized use of your computer.

You determine when the password is required within the BIOS Features Setup Menu and its Security option. If the Security option is set to "System", the password will be required both at boot and at entry to Setup. If set to "Setup", prompting only occurs when trying to

---

---

enter Setup.

### **3-13 Load Standard/Optimized Defaults**

#### **Load Standard Defaults**

When you press <Enter> on this item, you get confirmation dialog box with a message similar to:

Load Standard Defaults (Y/N)? N

Pressing <Y> loads the BIOS default values for the most stable, minimal-performance system operations.

#### **Load Optimized Defaults**

When you press <Enter> on this item, you get a confirmation dialog box with a message similar to:

Load Optimized Defaults (Y/N)? N

Pressing <Y> loads the default values that are factory settings for optimal performance system operations.